

Prepared by the International Labour Office
in collaboration with
the International Ergonomics Association



International
Labour
Office



International
Ergonomics
Association

E
R
G

CHECKPOINTS

N
O
M
I
C

SECOND
EDITION

PRACTICAL
AND EASY-TO-IMPLEMENT
SOLUTIONS FOR IMPROVING
SAFETY, HEALTH
AND WORKING CONDITIONS

Ergonomic checkpoints

Ergonomic checkpoints

**Practical and easy-to-implement solutions for improving
safety, health and working conditions**

Prepared by the International Labour Office
in collaboration with the International Ergonomics Association

Copyright © International Labour Organization 2010

First published 1996

Second edition 2010

Publications of the International Labour Office enjoy copyright under Protocol 2 of the Universal Copyright Convention. Nevertheless, short excerpts from them may be reproduced without authorization, on condition that the source is indicated. For rights of reproduction or translation, application should be made to ILO Publications (Rights and Permissions), International Labour Office, CH-1211 Geneva 22, Switzerland, or by email: pubdroit@ilo.org. The International Labour Office welcomes such applications.

Libraries, institutions and other users registered with reproduction rights organizations may make copies in accordance with the licences issued to them for this purpose. Visit www.ifrro.org to find the reproduction rights organization in your country.

International Labour Office, in collaboration with the International Ergonomics Association

Ergonomic checkpoints : Practical and easy-to-implement solutions for improving safety, health and working conditions. Second edition.

International Labour Office, Geneva, 2010

guide / ergonomics / occupational safety / occupational health / work environment / small enterprise

13.04.1

1 v.

ISBN 978-92-2-122666-6

ILO Cataloguing in Publication Data

The designations employed in ILO publications, which are in conformity with United Nations practice, and the presentation of material therein do not imply the expression of any opinion whatsoever on the part of the International Labour Office concerning the legal status of any country, area or territory or of its authorities, or concerning the delimitation of its frontiers.

The responsibility for opinions expressed in signed articles, studies and other contributions rests solely with their authors, and publication does not constitute an endorsement by the International Labour Office of the opinions expressed in them.

Reference to names of firms and commercial products and processes does not imply their endorsement by the International Labour Office, and any failure to mention a particular firm, commercial product or process is not a sign of disapproval.

ILO publications and electronic products can be obtained through major booksellers or ILO local offices in many countries, or direct from ILO Publications, International Labour Office, CH-1211 Geneva 22, Switzerland. Catalogues or lists of new publications are available free of charge from the above address, or by email: pubvente@ilo.org

Visit our website: www.ilo.org/publns

Foreword

There is growing awareness of the need to apply practical action in the workplace to reduce work-related accidents and diseases. An increasing focus is placed on the application of ergonomic principles in view of their great potential to improve working conditions and productivity. Experience is being gained in applying ergonomics to workplaces in different sectors and industrial situations in both developed and developing countries, with tangible results in the reduction of occupational accidents, work-related diseases and major industrial accidents, as well as improvements in unsatisfactory working conditions. *Ergonomic checkpoints* has been developed with the objective of offering practical, low-cost solutions to ergonomic problems, particularly for small and medium-sized enterprises.

This manual is based on numerous examples of practical ergonomic improvements achieved at low cost. There are many such examples worldwide, including ergonomically designed tools, carts, materials-handling techniques, workstation arrangements, work environments, worksite welfare facilities and group work methods. The knowledge gained from these locally achieved improvements is a very useful addition to the ergonomic applications developed by qualified specialists and trained practitioners. It is increasingly apparent that local improvements achieved at the shop floor level should be made known to other workplaces where similar improvements could be made. We hope that using *Ergonomic checkpoints* will stimulate this

valuable sharing of experiences and help people promote a more systematic application of ergonomic principles.

This manual presents 132 ergonomic interventions aimed at creating positive effects without relying on costly or highly sophisticated solutions. The emphasis is on realistic solutions that can be applied in a flexible manner and contribute to improving working conditions and productivity. The various experiences reported from practitioners in applying the first edition of *Ergonomic checkpoints* are reflected in revised text and illustrations and in the additional checkpoints. The close collaboration between the International Ergonomics Association and the International Labour Office has proved fruitful in making this second edition up to date, and meeting the most urgent needs of managing ergonomics-related workplace risks.

We hope that *Ergonomic checkpoints* will continue to inspire managers, supervisors, workers, trainers and educators, as well as ergonomics and occupational safety and health specialists, and will help them share practical information and experiences by disseminating ergonomically sound workplace improvements

Seiji Machida
Director

*Programme on Safety and Health
at the Workplace and the Environment (SafeWork)
International Labour Office*

Preface to the second edition

This book is a revised, expanded version of *Ergonomic checkpoints* and was compiled jointly by the International Ergonomics Association (IEA) and the International Labour Office (ILO) to present practical workplace improvements from an ergonomic point of view.

The first edition of *Ergonomic checkpoints*, published in 1996, was well received across the world and has been translated into more than a dozen languages, including Arabic, Bahasa Indonesian, Bahasa Malaysian, Chinese, Estonian, Farsi, French, Japanese, Korean, Polish, Portuguese, Russian, Spanish, Thai, Turkish and Vietnamese. It has been used in training programmes in a number of industrially developing countries in Asia, Africa and Latin America, and a range of small-scale workplaces in developing countries have reported improvements from applying the low-cost ideas in the manual. Practitioners of workplace ergonomics in industrialized countries have also found the checkpoints to be useful tools for improving working conditions, particularly work practices in small and medium-sized enterprises. Training activities have shown that the checkpoints can be used effectively to train local people to find realistic solutions to ergonomic problems in various workplace situations. The broad coverage of the checkpoints is particularly suited to identifying practical solutions to ergonomic problems in specific local situations, where priority issues can vary greatly.

In 2004, in view of the development in ergonomics in the last decade and feedback from applications and use by OSH and ergonomics practitioners, the ILO, with the International Development Committee of the IEA, began an in-depth review of the 1996 edition. A working group of experts led by Kazutaka Kogi was established by the IEA to prepare the basis for a joint review by the IEA and ILO, which was conducted at a workshop in Bali, Indonesia, in 2005. The workshop was facilitated by David Caple, IEA Chair of the International Development Committee, and Shengli Niu, ILO representative.

The working group for the second edition consisted of the following people:

- Sara Arphorn, Mahidol University, Bangkok, Thailand;
- Jose Maria Batino, Department of Labor and Employment, Manila, Philippines;
- David C. Caple, David Caple & Associates, East Ivanhoe, Australia;
- Pierre Falzon, International Ergonomics Association, Paris, France;
- Martin Helander, Nanyang Technologies University, Singapore;
- Toru Itani, Nagoya City University, Nagoya, Japan;
- Akiyoshi Ito, University of Occupational Health and Environment, Kitakyushu, Japan;
- Tsuyoshi Kawakami, ILO Regional Office for Asia and the Pacific, Bangkok, Thailand;
- Ton That Khai, Centre for Occupational Health and Environment, Cantho, Viet Nam;
- Halimahtun M. Khalid, Damai Sciences, Kuala Lumpur, Malaysia;
- Kazutaka Kogi, Institute for Science of Labour, Kawasaki, Japan;
- Sudthida Krungkraiwong, Institute for the Improvement of Working Conditions and Environment, Bangkok, Thailand;
- Shengli Niu, ILO, Geneva, Switzerland;
- Theresia Pawitra, Surabaya University, Surabaya, Indonesia;
- Budi Santoso Goutama, Surabaya University, Surabaya, Indonesia;
- Barbara Silverstein, Washington State Department of Labor and Industries, United States;
- Sutjana, University of Udayana, Denpasar, Indonesia;
- Errna Tresnaningsih, Division of Occupational Health, Jakarta, Indonesia.

As a result of this consultation, 132 revised checkpoints were put together for this second edition. Of the 128 items in the first edition, 104 were retained and eight new ones were created by merging two previous items each. Learning from the experiences in applying the first edition, the group developed 20 additional new items. The newly developed items relate to computer

workstations, forklift driving and driving cabins, work at height, cold work environments, air-conditioning systems, office work areas, labelling of containers of hazardous chemicals, waste recycling, confined spaces, fire extinguishers, evacuation plans, physical exercise, full participation of women and men workers, migrant workers, young workers, cultural issues and risk management systems.

A further new feature of this second edition is that each checkpoint mentions risks/symptoms addressed by the suggested ergonomic solutions. Depending on the local situation, users can thus select practical improvements applicable to their own workplace, and devise their own checklists. The various ways to use the checkpoints and the ergonomic checklist are described in "Suggestions for using the manual" on pp. xiii–xviii.

In compiling the checkpoints, emphasis has been placed on a visual presentation that helps users solve concrete problems. The analytical part, therefore, is minimized in favour of practical solutions. This is concordant with the approach used in the ILO programme, which has proved to be effective in both industrially developed and developing countries.

The manual is a result of the joint efforts of many people who worked together with the group of

experts. It includes all new graphics, redrawn in colour by Nguuyen Thi Sam in collaboration with Ton That Khai, both of the Centre for Occupational Health and Environment of the Cantho Health Department in Viet Nam. Most of these graphics are based on original drawings from the first edition and other ILO publications, with appropriate modification. In addition, new drawings were developed based on the experience gained in related training programmes.

The ILO acknowledges the contributions and support of Pierre Falzon and David Caple, IEA Presidents for 2003–06 and for 2006–09, respectively, to the joint preparation of this second edition. Thanks are also due to the IEA Council both for the material used in the checkpoints and for its intellectual support.

Thanks are due in particular to Jukka Takala and Sameera Al-Tuwaijri, former Directors of the ILO Programme on Safety and Health at Work and the Environment (SafeWork), and to Seiji Machida, SafeWork's current Director, for their support.

The ILO and IEA hope that this revised publication will continue to serve as a practical tool for improving places of work in many parts of the world.

Shengli Niu, Co-Editor
Senior Specialist on Occupational Health
Programme on Safety and Health and the Environment
(SafeWork)
International Labour Office

Kazutaka Kogi, Co-Editor
Chairperson
IEA Working Group for
Ergonomic checkpoints, second edition
International Ergonomic Association

Preface to the first edition

This book is a compilation of “ergonomic checkpoints” that can be used to find practical solutions for improving working conditions from an ergonomic points of view. Its aim is to provide a useful tool for all those who intend to improve their working conditions for better safety, health and efficiency.

Ergonomic checkpoints is intended for those wishing to apply practical improvements to existing working conditions. The book covers all the main ergonomic issues at the workplace: materials storage and handling; hand tools; productive machine safety; improving workstation design; lighting; premises; control of hazardous substances and agents; welfare facilities; and work organization. It is thus suited to identifying practical solutions to ergonomic problems in each local situation. The manual can help users to look for such solutions, as each checkpoint indicates an action. Available options for that action, as well as some additional hints, are given. Users can select those checkpoints which are applicable to their own workplace and use the “action” sentences immediately as a checklist adapted to the particular workplace. The users of this book may thus use all or part of the checkpoints, as determined by the local situation (see “Suggestions for using the manual”, pp. xi–xii, for further details).

Ergonomic checkpoints is presented as the next step to the ILO publication *Higher productivity and a better place to work: Action manual*, published in 1988 as a guide to improving workplaces in small and medium-sized enterprises. This earlier publication has been used widely in training activities in different regions of the world. The manual is an effective tool in the ILO’s training approach, “Work Improvement in Small Enterprises” (WISE). The approach is being applied to a variety of activities in many developing countries within the framework of the ILO’s International Programme for the Improvement of Working Conditions and Environment (known as PIACT after its French name). As a follow-up to these activities, *Ergonomic checkpoints* forms an integral part of the ILO programme.

Ergonomic checkpoints is the result of collaboration between the International Labour Office and the International Ergonomics Association (IEA). In 1991, the IEA Technology Transfer Committee established a group of experts, chaired by Najmedin Meshkati, to create an outline of the document and to produce a major part of

the material. The group was piloted mainly by Kazutaka Kogi from the ILO and Ilkka Kuorinka from the IEA. Tuulikki Kuorinka assembled the different manuscripts and Kazutaka Kogi further edited the checkpoints.

The core group for compiling *Ergonomic checkpoints* consisted of the following people:

- Martin Helander, State University of New York, Buffalo, United States;
- Andrew Imada, University of Southern California, Los Angeles, United States;
- Kazutaka Kogi, International Labour Office, Geneva, Switzerland;
- Stephen Konz, Kansas State University, Manhattan, United States;
- Ilkka Kuorinka, Institut de Recherches en Santé et Sécurité de Travail de Québec (IRSST), Montreal, Canada;
- Tuulikki Kuorinka, IRSST, Montreal, Canada;
- Wolfgang Laurig, Institut für Arbeitsphysiologie, Dortmund, Germany;
- Najmedin Meshkati, University of Southern California, Los Angeles, United States;
- Houshang Shahnavaz, Luleå University of Technology, Luleå, Sweden.

The group of experts identified several main areas where the contribution of ergonomics to working conditions was assessed to be most important for small enterprises. For each area, 10 to 20 checkpoint items were developed. As a result, 128 checkpoints have been put together. In developing the checkpoints, the emphasis has been on a concrete and visual presentation, with the goals of problem solving and solution finding. The analytical part, therefore, is minimized in favour of practical solutions. This is concordant with the approach used in the ILO programme that has proved to be effective in both industrially developed and developing countries.

In 1993, the checkpoints were tested in Indonesia and Thailand in two “roving seminars” organized jointly by the ILO and the IEA, in collaboration with the South-East Asian Ergonomics Society. These seminars demonstrated that the checkpoints can be used effectively in training local people to find realistic

solutions to ergonomic problems at workplaces in a developing situation.

The manual is a product of the joint efforts of many people who worked together with the group of experts. Hamid Kavianian, California State University, Long Beach, and Karl Kroemer, Virginia Polytechnic Institute and State University, Radford, United States, took part in the drafting of some of the checkpoints. Jürgen Serbitzer and Valentina Forastieri of the ILO conducted initial research.

Ellen Roskam Krasnosselski and Juan-Carlos Hiba of the ILO compiled the illustrations together with the expert group. They include graphics drawn by Vlad Ganea and Igor Lossavio. Other drawings are taken from *Safety, health and working conditions*, a training manual published by the Joint Industrial Safety Council of Sweden (Stockholm, 1987), and from previous ILO publications.

At the request of the IEA Education and Training Committee (Chair, Margaret Bullock), the following people worked together in applying the checkpoints in

the “roving seminars”: Kamiel Vanwonderghem, KV-Ergonomics, Hasselt, Belgium; Kitti Intaranont, Chulalongkorn University, Bangkok, Thailand; Chaiyuth Chavalitnitikul, Ministry of Labour and Social Welfare, National Institute for the Improvement of Working Conditions and Environment, Bangkok, Thailand; and Adnyana Manuaba, University of Udayana, Denpasar, Indonesia. The collaboration of the IEA led by Hal W. Hendrick, former President, is highly appreciated. Thanks are due also to the IEA Council for both material and intellectual support. The initiative of the ILO in realizing this project as part of its regular budget and programme activities is also greatly appreciated. Thanks are particularly due to Claude Dumont, Director of the Working Conditions and Environment Department, and Chandra Pinnagoda, Chief of the Occupational Safety and Health Branch, for their support.

The authors hope that this new publication will serve as an impetus for practical improvements at many places of work in different parts of the world.

Contents

Foreword	v
Preface to the second edition	vii
Preface to the first edition	ix
Suggestions for using the manual	xiii
Ergonomic checklist	xix
Materials storage and handling	1
(checkpoints 1–17)	
Hand tools	37
(checkpoints 18–31)	
Machine safety	67
(checkpoints 32–50)	
Workstation design	107
(checkpoints 51–63)	
Lighting	135
(checkpoints 64–72)	
Premises	155
(checkpoints 73–84)	
Hazardous substances and agents	181
(checkpoints 85–94)	
Welfare facilities	203
(checkpoints 95–105)	
Work organization	227
(checkpoints 106–132)	
Annexes	283
Annex 1: Using <i>Ergonomic checkpoints</i> in participatory training	
Annex 2: Workplace checklist	
Annex 3: Practical hints for the workplace checklist	
Annex 4: Sample programmes for a training workshop using <i>Ergonomic checkpoints</i>	
Annex 5: Examples of group work results	

Suggestions for using the manual

The suggestions given here for using *Ergonomic checkpoints* are based on training experiences gained through the use of its first edition, particularly in industrially developing countries. These experiences relate to training programmes applying the Work Improvement in Small Enterprises (WISE) methodology developed by the ILO and similar participatory action-oriented training methods. Many members of the working group for this second edition have taken part in these training activities. As is described in Annex 1, the link with these participatory methods was kept in mind during the editing of this manual.

When implementing workplace improvements, it is useful to utilize the guidance provided by the checkpoints. The improvement actions indicated by the checkpoints are based on a number of underlying ergonomic principles that are readily applicable in real workplaces, including the following:

- immediate solutions need to be developed with the active involvement of managers and workers;
- group work is advantageous for planning and implementing practical improvements;
- the use of available local materials and expertise has many benefits;
- multifaceted action should ensure that improvements are sustained over time; and
- continuing action programmes are needed to create locally adjusted improvements.

The compiled checkpoints are suited to their application reflecting these underlying principles. These checkpoints represent simple, low-cost, readily applicable ergonomic improvements. The easy-to-implement nature of the improvements favours group work and implementation by means of local materials and skills. As the checkpoints cover broad areas, users are guided to take multifaceted action according to each local situation. The many illustrations showing widely applicable low-cost ideas can also help users find locally adjusted solutions.

There are four main ways of using the ergonomic checkpoints compiled in this book:

1. applying selected checkpoints to the workplace;
2. designing locally adapted, handy checklists;
3. making ready-to-use information sheets; and
4. organizing training workshops for planning and implementing immediate workplace changes.

1. Applying selected checkpoints to the workplace

In applying ergonomic checkpoints to a particular workplace, it is advisable to select a certain number of checkpoint items considered important for the workplace. Usually, around 20–30 items are suited for initial application of the manual. Copies of the corresponding pages of the selected checkpoint items may be distributed for use in introductory sessions of occupational safety and health, ergonomic interventions or workplace risk management.

Based on the selected items, a short checklist may be formed by using the format of the ergonomic checklist contained in the manual. Such a checklist is suitable for initial introductory sessions, especially when the checklist is used together with copies of the selected pages of the manual. If time allows, it is recommended to develop a locally adapted checklist suited to the workplace, as described in the following section.

In applying these selected checkpoints, or using them for training purposes, it is useful to organize worksite walk-throughs. The short checklist can greatly help these walk-throughs, as it helps participants take a fresh look at the workplaces visited and find practical improvement points. Remember to ask people to also find existing good points, as these are helpful in subsequent discussions.

The results of the workplace visits should be discussed in small groups and then examined in a meeting of all the participants or group representatives. The group work of people using the selected checkpoint items is essential to identifying locally practicable improvements.

As indicated in the following sections, it is important to look at multiple aspects of workplace conditions. Therefore it is advisable to select at least a few items from several chapters in the manual, to cover materials storage and handling, tool and machine safety, workstation design, physical environment, welfare facilities and work organization.

The brief checklist and the materials based on the selected checkpoint items can help people prioritize immediate actions to be taken. They may choose both short- and long-term priorities. As there are simple, low-cost actions in all these areas, it should be relatively easy to select appropriate checkpoint items by taking into account the particular conditions of the workplaces concerned.

2. Designing locally adapted, handy checklists

The aim is to design and use a locally adapted checklist made up of selected checkpoints. Such a checklist can be a powerful tool for ergonomic assessment and improvement of existing working conditions.

As the checkpoints compiled in this manual represent readily applicable workplace improvements, the ergonomic checklist on pages xix–xxx of the manual can be used as a reference table for selecting those checkpoints suited to the local situation. This design process is usually done by group work, as follows:

1. The main areas requiring immediate improvements should be agreed on through group work. Usually, particular aspects of materials storage and handling, machine safety, workstation design, lighting, premises, welfare facilities and work organization may be pointed out.
2. It is advisable to select a limited number of checkpoint titles from among those listed in the ergonomic checklist. As a rule, a few to several items may be selected for each of the areas targeted.
3. The selected items can be put together to form a draft checklist of about 30–50 items to cover the chosen areas. This draft checklist can follow a similar format to the ergonomic checklist, as this (replying to the question “Do you propose action?” by NO or YES and pointing out whether the action is PRIORITY or not) is beneficial because it helps users propose priority improvements in the local context. The draft may be tested through its pilot use including a walk-through round a particular workplace. By obtaining feedback from this pilot use, a locally adapted checklist can be finalized.
4. The checklist can be supplemented by a brochure containing the corresponding photocopied pages of this manual. The brochure, comprising two pages each for the selected 30–50 items, can be used as a reference material for available low-cost options.

This combination of a locally designed checklist and a brochure explaining the corresponding checkpoints can be used in actual implementation of workplace improvements. Their design process can be undertaken, for example, by members of a safety and health committee, a special task group including representatives of management and trade union members, a working party consisting of workplace managers, supervisors and workers, or a special circle formed for particular ergonomic action. Such groups of local people can undertake both the design and immediate use of the checklist and the associated brochure.

The whole process of designing and utilizing a locally adapted checklist and an associated brochure may be summarized as follows:

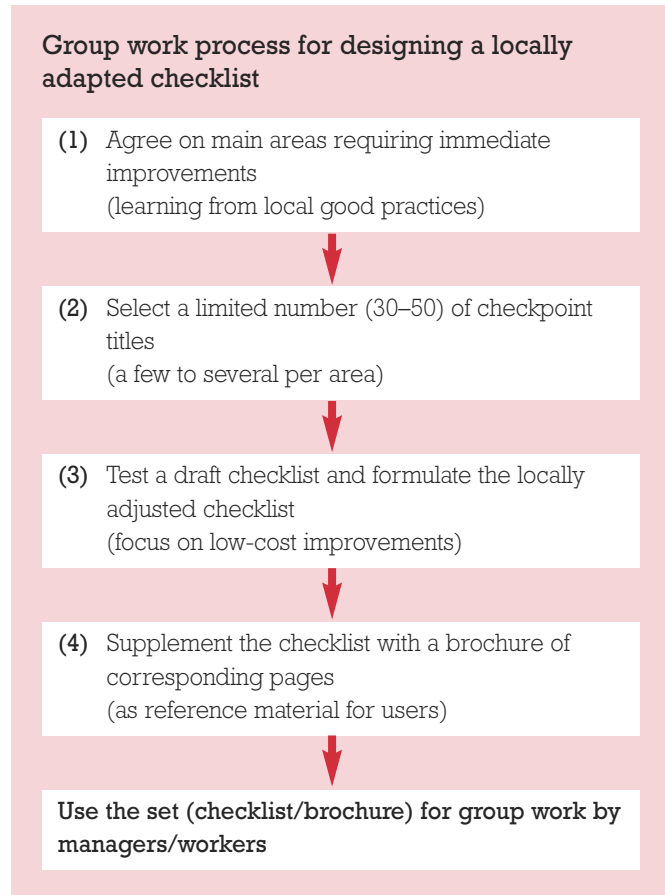

It should be noted that a locally adapted checklist formulated in this way is used to find readily practicable improvements rather than to make a complete appraisal of the ergonomic conditions of the workplace in question. This is because it is better to make stepwise progress in improving various ergonomic aspects.

Therefore it is recommended to design a relatively short checklist comprising about 30–50 items, as described above, instead of trying to formulate a lengthy checklist comprising all the relevant items of this manual. At first glance, a lengthy checklist may appear to be more comprehensive, but may not be used actively by local people because it is lengthy and more complicated. A short and handy checklist is far more suited to voluntary use. By going through the short list of available ideas in multifaceted aspects, users are more inclined to look for feasible options and thus proceed to group work on selecting priorities. This group-motivating nature of a locally adapted checklist should be kept in mind.

When specific aspects of ergonomic conditions require particular attention, a more specific checklist may be designed by concentrating on these particular aspects. For example, a checklist relating mainly to physical tasks may be formulated when local people agree to focus on musculoskeletal complaints. Or a checklist focusing on visual display unit work may be designed. In such cases, however, it is advisable to formulate a checklist of about 30–50 items initially and cover multifaceted aspects of ergonomic conditions as much as possible. This is explained by the fact that such specific issues are also affected variously by multifaceted factors and the experiences, and a relatively short list can lead to lively discussions about how to deal with multiple factors.

There are many examples of locally adapted checklists. The original WISE checklist that has been widely applied since the 1980s has 44 items covering all the areas in this manual. This WISE checklist represents an ergonomic action-oriented checklist for small and medium enterprises. A short version of a locally adapted checklist for use in small enterprises was recently designed by a working group in Malaysia. This checklist is suited to enterprise-level group work and to basic training in ergonomic action.

The checklist lists 24 action items together with typical illustrations showing low-cost ideas. It is supplemented by a brochure explaining fundamental low-cost options with regard to these 24 actions, together with a typical illustration and a local good example photograph for each. For easy reference, this checklist is annexed to this manual (Annex 2).

It is expected to exchange various sets of checklists and associated brochures in different industries and settings. A recent tendency is to design an illustrated checklist by selecting 30–40 items through learning from local good examples in multiple areas.

3. Making ready-to-use information sheets

Various designed information sheets explaining practical ergonomic improvements can be produced by making use of this manual. The simple, uniform structure of each checkpoint in the manual is beneficial for this purpose. The manual's colour illustrations also favour the making of easy reference sheets.

There are three basic options for creating information sheets by using the checkpoint pages of this manual:

1. Single information sheets

Each checkpoint in the manual consists of two pages, so any of the checkpoints can be photocopied and offered as a two-page information sheet. Depending on local

needs, a set of such single information sheets can be also reproduced. These sheets may be distributed to various groups of people or as supplementary materials for training programmes.

2. Brochure-type information sheets

Selected checkpoints in the manual can be edited as a brochure. The selection of checkpoints to be included in the brochure may be done by an editing group. A variety of brochures can be designed, for example brochures containing checkpoints applicable to a particular type of workplace or those relating to a specific ergonomic aspect or specific risks, such as manual handling, hand tools, computer workstations, muscle strain, upper limb disorders, eye strain, injury risks, heat and cold, chemical risks, work stress, preventing mistakes, emergencies, work organization, young workers, etc.

3. Locally adapted information sheets

Another useful way of producing information sheets from the manual is to re-edit the pages of the checkpoints by adding remarks and materials reflecting local conditions. This is relatively easy to do, as the emphasis of the manual is on simple and practical improvements. In particular, handy brochures may be created by mentioning good examples achieved locally, in line with these practical options. Brochures showing photographs of local good examples are useful for encouraging similar improvements in small and medium enterprises, in a particular industry or in particular types of jobs. Sample pages of such a brochure for small enterprises in Malaysia are attached (Annex 3).

4. Organizing training workshops for immediate workplace changes

A practical way of using the manual in training in implementing workplace improvements is to organize short training workshops to train local people to apply basic ergonomic principles. A number of countries have reported using the manual for this purpose in various training workshops.

Experiences in WISE training activities and similar participatory programmes have shown the effectiveness of training workshops of 1–4 days that take a good practice approach building on local practice. *Ergonomic checkpoints* can be used as action-oriented training materials.

Such training workshops can be combined with the use of locally adapted checklists, brochures or information materials described in the previous sections.

In following the good practice approach, an action-oriented training workshop can be organized by: (a) collecting local good examples; (b) holding sessions about identifying low-cost ideas for improving workplace conditions through applying available options; and (c) following a group work process to learn how to propose and implement practicable improvements.

The initial step of collecting local good examples seems particularly useful. These good examples can show the range of ergonomic problems and their locally achievable solutions. Checklists indicating locally available options and corresponding pages of this manual can be used as a tool for connecting these good practices with ergonomic improvements and for guiding trainees towards the immediate implementation of these improvements. Group work is essential in following these steps.

Typical participatory steps in an action-oriented training workshop by means of this manual may be as follows:

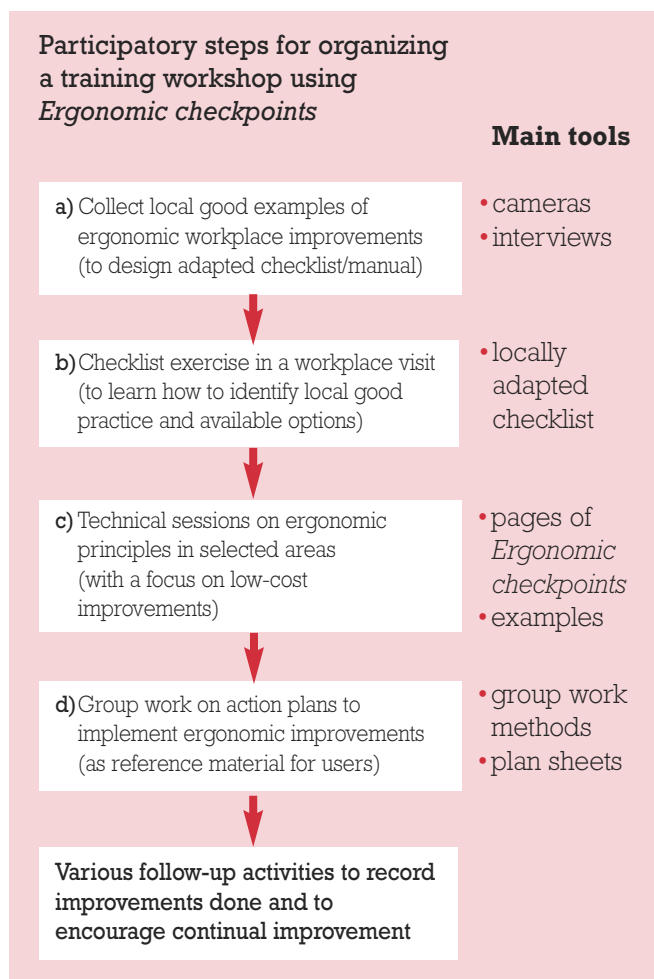

These training steps usually take 1–4 days. It is important to serially organize group discussion sessions. Each session (1 to 1½ hours) should preferably consist of a presentation by a trainer, group discussion in small groups and presentation of group results. In this way, participants can learn practical ways to apply the checklist and propose practicable improvements that have real impacts on the workplace.

In the case of a one- or two-day workshop, the checklist exercise may be undertaken in the morning of the first day. This enables participants to use their check results in subsequent training sessions on a few chosen technical areas. Experience shows that it is useful to have sessions at least on materials storage and handling, workstation design and physical environment. In a two-day workshop, sessions on machine safety, welfare facilities and work organization may be added.

A three- or four-day workshop can cover all the main technical areas in the manual. For example, after the checklist exercise, sessions may be held on materials storage and handling, tool and machine safety, workstation design, lighting, physical environment, welfare facilities and work organization. Case studies of successful cases and a session on how to implement practical improvements may be added. It is useful to encourage participants to present their own action plans.

The emphasis of all the sessions should be on learning from local good examples, proposing improvements that apply basic ergonomic principles, and learning group work procedures to agree on immediately practicable improvements.

Sample programmes from a two-day and a four-day workshop are given in Annex 4. It should be noted that these programmes are carried out in the form of serial group work sessions. The commonly useful training tools comprise a locally adapted checklist, local good examples (e.g. photographs with short remarks) and the corresponding pages of relevant checkpoints in this manual.

5. Practical hints for implementing improvements

Workplace improvements can be made by taking advantage of the action-oriented nature of this manual. The above suggestions give some common practical hints on using the manual.

It is always useful to rely on local good practice (as shown by local good examples) and to undertake

participatory group work steps. The information in this manual can help people look at available improvement options in multiple technical areas and propose simple, low-cost improvements that are practicable in the given local conditions. The following hints may help in effectively using this manual.

1. Use an “action checklist” for taking a fresh look at workplace conditions

Ergonomic checklists can help people systematically examine existing workplace conditions. The action form of check items as indicated by the ergonomic checklist in this manual is very useful to guide people in looking at locally practicable improvements. As a lengthy checklist is rather difficult to apply, it is advisable to design an action-form checklist listing a limited number of low-cost options. Such a checklist will provide local people with opportunities to identify potential improvements with a fresh look.

2. Learn from good examples done in local workplaces

Locally achieved examples of workplace improvements demonstrate not only their merits but also their feasibility. These good examples provide an insight into the ways improvements are implemented in difficult local conditions, and so can encourage local people to take action on their own. In this context, local good examples provide many useful hints for undertaking improvements in terms of workable ideas, skills, costs, materials and cooperation among managers and workers. Further, looking at achievements rather than pointing out weaknesses always helps promote positive and constructive thinking, which can lead to real improvements.

3. Develop improvement ideas that can work

When a new improvement idea is proposed, it is important to make sure that the idea can work in the real local situation. Good examples learned from local workplaces can help look at this feasibility. Starting from low-cost ideas is always pragmatic, as these ideas are usually feasible using local materials and skills.

4. Mobilize worker support

In making changes, it is always necessary to make clear to workers concerned that the planned changes will lead to benefits and progress and will not adversely affect their jobs. It is important to inform workers of the changes to be made and to explain their rationale and

benefits in advance. It is also necessary to provide advance training and consult workers about possible unintended effects. The best way to avoid resistance to changes is to plan and implement the changes jointly with the workers concerned.

5. Make improvements that will last

A useful way to make a change that will last is to build the change into equipment or facilities. It is difficult to depend entirely on changing people's attitudes and habits. Changes built into equipment or facilities tend to last. It is always better to provide adequate means of storage and transport rather than to merely emphasize good housekeeping. With racks, containers and mobile devices, good housekeeping practices are more likely to last and have the intended effect.

6. Always discuss in a group

Better solutions are always found by discussing multiple ideas coming from many people. It is essential to always discuss in a group, respecting each other's ideas and keeping a positive stance. Group discussions also help people exchange experiences about how to prioritize actions derived from many ideas. This is because group discussions help people compare different ideas and their benefits and reach a consensus that is beneficial to the people concerned.

7. Manage change

Technical expertise alone is not sufficient to make successful changes. It is the responsibility of local people in charge of the workplace to make the changes a success. There are certain points they should pay attention to:

- establish a firm deadline;
- assign the responsibility for implementation to someone;
- allocate adequate resources (time, materials, money, technical skills);
- request regular reports on progress; and
- make sure that people who take part in the improvement process are rewarded and praised.

8. Promote both short-term and long-term improvement plans

It is advisable to advance improvement plans on a step-by-step basis. This requires priority setting from the

viewpoints of both local needs and feasibility in terms of costs and technical possibilities. Ideas that can meet immediate local needs can be first put into practice on a short-term basis. Once small but effective improvements are carried out, people become confident of taking the next steps that may need more time and costs. Thus it is always sensible to develop both short- and long-term improvement plans.

6. Follow-up activities

Training in the use of an ergonomic checklist and information on checkpoints is not the end but the beginning of improvement actions. It is essential to make a concrete plan on follow-up activities that involve local people after the training. The purposes of follow-up activities are to: (a) see what improvements are undertaken in local conditions; (b) understand what further support is needed to continue improvements while overcoming constraints; and (c) to encourage continued efforts by facilitating the exchange of improvement experiences.

In these follow-up activities, the action-oriented features of this manual can help organize the activities in a systematic way. The various improvement options presented in the manual and the broad scope of these options can provide a useful basis for knowing the effectiveness of the follow-up activities.

The manual can be used to organize effective follow-up activities as follows:

1. In follow-up visits:

Visits to workplaces participating in the training activities provide useful opportunities to learn about their achievements and what support they need. A good time for these visits is a few weeks or a few months after a training workshop. It is a good idea to get those in the workplace to complete follow-up sheets. The visits also provide an occasion to appreciate the actions taken and encourage further efforts. The various checkpoints in the manual may be used as a reference to record achievements and advise on continued efforts. In dealing with difficulties encountered in the workplace, the options in the manual are useful for discussion among managers and workers.

2. In follow-up meetings:

Follow-up meetings are very useful for exchanging improvement experiences and discussing the support needed. Such meetings can be organized at intervals from several to months to a year after training. It is

always better to fix the date and place of the next follow-up meeting in advance. Usually, half a day to one day will be long enough for such a meeting. The purpose should be for participants to report on their achievements, focus on the effective ones, and exchange know-how regarding continuing improvements. The broad areas covered and the various hints in the manual can be used to arrange the meeting agenda. Good examples and success stories reported can be included in training and information materials.

3. In facilitating the exchange of positive experiences:

An important follow-up activity is to link the positive results gained through the training and follow-up activities with existing networking arrangements. Examples include the use of websites to disseminate positive experiences and local good examples, and the publication of newsletters and leaflets with these examples and new ideas. The information on basic ergonomic principles and improvement options in this manual can certainly help people emphasize commonly applicable ideas.

7. Linking achievements with improvement actions

Throughout the training and information activities and the follow-up activities using the manual, it is important to link the locally achieved positive experiences with the proposals and plans for improvement actions. This is best done by organizing group work on different aspects of ergonomic checkpoints as described in this manual. A good example of discussing the link in group discussions is to discuss and agree on three good points already achieved at the workplace and three points to be improved. These points should be used to discuss priority actions to be taken jointly.

It is recommended to use local achievements as the basis for developing practical and innovative ideas in the local context. The technical areas discussed in the manual are arranged according to the common types of such local achievements so as to help people explore locally practicable ideas. The discussions of good points and points to be improved thus help people look at potential improvements in the local context.

For easy reference and to increase the usefulness of the manual's technical categories, Annex 5 gives examples of group work results based on the checklist exercises. These were carried out in a textile factory in Pakistan as part of participatory training activities by trade unions.

ERGONOMIC CHECKLIST

How to use the checklist

This checklist is a list of the titles of the ergonomic checkpoints included in this manual. There are 132 items in the list. You may use either the whole list or your own list containing only those items relevant to your workplace. A checklist of about 30–50 items suitable for your workplace is usually easier to apply.

1. Knowing the workplace

Ask the manager any questions you have. You should know about the main products and production methods, the number of workers (male and female), the hours of work (including breaks and overtime) and any important labour problems.

2. Defining the work area to be checked

Define the work area to be checked in consultation with the manager and other key people. In the case of a small enterprise, the whole production area can be checked. In the case of a larger enterprise, particular work areas can be defined for separate checking.

3. Initial walk-through

Read through the checklist and spend several or more minutes walking through the work area before starting to check using the checklist.

4. Writing your check results

Read each item carefully. Look for a way to apply the measure. If necessary, ask the manager or workers questions.

- If the measure has already been taken properly or is not needed, mark NO under “Do you propose action?”
- If you think the measure would be worthwhile, mark YES.
- Use the space under “Remarks” to put a description of your suggestion or its location.

5. Selecting priorities

After you have finished, look again at the items you have marked YES. Choose a few items where the benefits seem likely to be the most important. Mark PRIORITY for these items.

6. Group discussion about the check results

Discuss the check results jointly with others who have taken part in the walk-through. Agree on the existing good points and on the measures to be taken on the basis of the checklist application. Communicate with the manager and workers about the proposed measures, and follow up on the implementation of these measures.

Materials storage and handling

1. Clear and mark transport routes.

Do you propose action?

NO YES PRIORITY

Remarks

2. Keep aisles and corridors wide enough to allow two-way transport.

Do you propose action?

NO YES PRIORITY

Remarks

3. Make the surface of transport routes even, not slippery, and without obstacles.

Do you propose action?

NO YES PRIORITY

Remarks

4. Provide ramps with a small inclination instead of small stairways or sudden height differences within the workplace.

Do you propose action?

NO YES PRIORITY

Remarks

5. Improve the layout of the work area so that the need to move materials is minimized.

Do you propose action?

NO YES PRIORITY

Remarks

.....

6. Use carts, hand-trucks and other wheeled devices, or rollers, when moving materials.

Do you propose action?

NO YES PRIORITY

Remarks

.....

7. Use mobile storage racks to avoid unnecessary loading and unloading.

Do you propose action?

NO YES PRIORITY

Remarks

.....

8. Use multi-level shelves or racks near the work area in order to minimize manual transport of materials.

Do you propose action?

NO YES PRIORITY

Remarks

.....

9. Use mechanical devices for lifting, lowering and moving heavy materials.

Do you propose action?

NO YES PRIORITY

Remarks

.....

10. Reduce manual handling of materials by using conveyers, hoists and other mechanical means of transport.

Do you propose action?

NO YES PRIORITY

Remarks

.....

11. Instead of carrying heavy weights, divide them into smaller lightweight packages, containers or trays.

Do you propose action?

NO YES PRIORITY

Remarks

.....

12. Provide handholds, grips or good holding points for all packages and containers.

Do you propose action?

NO YES PRIORITY

Remarks

.....

13. Move materials horizontally at the same working height.

Do you propose action?

NO YES PRIORITY

Remarks

.....

14. Eliminate tasks that require bending or twisting while handling materials.

Do you propose action?

NO YES PRIORITY

Remarks

.....

15. Keep objects close to the body when manually handling materials.

Do you propose action?

NO YES PRIORITY

Remarks

.....

16. Combine heavy lifting with physically lighter tasks to avoid injury and fatigue and to increase efficiency.

Do you propose action?

NO YES PRIORITY

Remarks

.....

17. Provide conveniently placed waste containers.

Do you propose action?

NO YES PRIORITY

Remarks

23. Minimize the weight of tools (except for striking tools).

Do you propose action?

NO YES PRIORITY

Remarks

Hand tools

18. Select tools designed for the specific task requirements.

Do you propose action?

NO YES PRIORITY

Remarks

24. For hand tools, provide the tool with a grip of the proper thickness, length, shape and size for easy handling.

Do you propose action?

NO YES PRIORITY

Remarks

19. Provide safe power tools and make sure that safety guards are used.

Do you propose action?

NO YES PRIORITY

Remarks

25. Provide hand tools with grips that have adequate friction or with guards or stoppers to avoid slips and pinches.

Do you propose action?

NO YES PRIORITY

Remarks

20. Use hanging tools for operations repeated in the same place.

Do you propose action?

NO YES PRIORITY

Remarks

26. Provide tools with proper insulation to avoid burns and electric shocks.

Do you propose action?

NO YES PRIORITY

Remarks

21. Use vices and clamps to hold materials or work items.

Do you propose action?

NO YES PRIORITY

Remarks

27. Minimize vibration and noise of hand tools.

Do you propose action?

NO YES PRIORITY

Remarks

22. Provide hand support when using precision tools.

Do you propose action?

NO YES PRIORITY

Remarks

28. Provide a "home" for each tool.

Do you propose action?

NO YES PRIORITY

Remarks

29. Inspect and maintain hand tools regularly.

Do you propose action?

NO YES PRIORITY

Remarks

30. Train workers before allowing them to use power tools.

Do you propose action?

NO YES PRIORITY

Remarks

31. Provide enough space for stable postures and stable footing during power tool operation.

Do you propose action?

NO YES PRIORITY

Remarks

Machine safety

32. Design controls to prevent unintentional operation.

Do you propose action?

NO YES PRIORITY

Remarks

33. Make emergency controls clearly visible and easily accessible from the natural position of the operator.

Do you propose action?

NO YES PRIORITY

Remarks

34. Make different controls easy to distinguish from each other.

Do you propose action?

NO YES PRIORITY

Remarks

35. Make sure that the worker can see and reach all controls comfortably.

Do you propose action?

NO YES PRIORITY

Remarks

36. Locate controls in sequence of operation.

Do you propose action?

NO YES PRIORITY

Remarks

37. Use natural expectations for control movements.

Do you propose action?

NO YES PRIORITY

Remarks

38. Limit the number of foot pedals and, if used, make them easy to operate.

Do you propose action?

NO YES PRIORITY

Remarks

39. Make displays and signals easy to distinguish from each other and easy to read.

Do you propose action?

NO YES PRIORITY

Remarks

40. Use markings or colours on displays to help workers understand what to do.

Do you propose action?

NO YES PRIORITY

Remarks

41. Use symbols only if they are easily understood by local people.

Do you propose action?

NO YES PRIORITY

Remarks

.....

42. Make labels and signs easy to see, easy to read and easy to understand.

Do you propose action?

NO YES PRIORITY

Remarks

.....

43. Use warning signs that workers understand easily and correctly.

Do you propose action?

NO YES PRIORITY

Remarks

.....

44. Use jigs and fixtures to make machine operation stable, safe and efficient.

Do you propose action?

NO YES PRIORITY

Remarks

.....

45. Purchase machines that meet safety criteria.

Do you propose action?

NO YES PRIORITY

Remarks

.....

46. Use feeding and ejection devices to keep the hands away from dangerous parts of machinery.

Do you propose action?

NO YES PRIORITY

Remarks

.....

47. Use properly fixed guards or barriers to prevent contact with moving parts of machines.

Do you propose action?

NO YES PRIORITY

Remarks

.....

48. Use interlock barriers to make it impossible for workers to reach dangerous points when the machine is in operation.

Do you propose action?

NO YES PRIORITY

Remarks

.....

49. Establish safe procedures for forklift driving by modifying the workplace and providing adequate training.

Do you propose action?

NO YES PRIORITY

Remarks

.....

50. Inspect, clean and maintain machines regularly, including electric wiring.

Do you propose action?

NO YES PRIORITY

Remarks

.....

Workstation design

51. Adjust the working height for each worker at elbow level or slightly below it.

Do you propose action?

NO YES PRIORITY

Remarks

.....

52. Make sure that the workplace accommodates the needs of smaller workers.

Do you propose action?

NO YES PRIORITY

Remarks

53. Make sure that the workplace accommodates the needs of taller workers.

Do you propose action?

NO YES PRIORITY

Remarks

54. Place frequently used materials, tools and controls within easy reach.

Do you propose action?

NO YES PRIORITY

Remarks

55. Provide a stable multi-purpose work surface at each workstation.

Do you propose action?

NO YES PRIORITY

Remarks

56. Make sure that workers can stand naturally, with weight on both feet, and perform work close to and in front of the body.

Do you propose action?

NO YES PRIORITY

Remarks

57. Allow workers to alternate standing and sitting at work as much as possible.

Do you propose action?

NO YES PRIORITY

Remarks

58. Provide standing workers with chairs or stools for occasional sitting.

Do you propose action?

NO YES PRIORITY

Remarks

59. Provide sitting workers with good adjustable chairs with a backrest.

Do you propose action?

NO YES PRIORITY

Remarks

60. Use height-adjusted computer workstations and arrange related computer peripherals within easy reach.

Do you propose action?

NO YES PRIORITY

Remarks

61. Provide eye examinations and proper glasses for workers using a visual display unit (VDU) regularly.

Do you propose action?

NO YES PRIORITY

Remarks

62. Provide a sound and stable footing and sufficient guarding arrangements for work in high places.

Do you propose action?

NO YES PRIORITY

Remarks

63. Increase safety and comfort of driving cabins and seats of vehicles used at the workplace.

Do you propose action?

NO YES PRIORITY

Remarks

Lighting

64. Increase the use of daylight and provide an outside view.

Do you propose action?

NO YES PRIORITY

Remarks

65. Use light colours for walls and ceilings when more light is needed.

Do you propose action?

NO YES PRIORITY

Remarks

66. Light up corridors, staircases, ramps and other areas where people may walk or work.

Do you propose action?

NO YES PRIORITY

Remarks

67. Light up the work area evenly to minimize changes in brightness.

Do you propose action?

NO YES PRIORITY

Remarks

68. Provide sufficient lighting for workers so that they can work efficiently and comfortably at all times.

Do you propose action?

NO YES PRIORITY

Remarks

69. Provide local lights for precision or inspection work.

Do you propose action?

NO YES PRIORITY

Remarks

70. Relocate light sources or provide shields to eliminate direct and indirect glare.

Do you propose action?

NO YES PRIORITY

Remarks

71. Choose an appropriate visual task background for tasks requiring close, continuous attention.

Do you propose action?

NO YES PRIORITY

Remarks

72. Clean windows and maintain light sources.

Do you propose action?

NO YES PRIORITY

Remarks

Premises

73. Protect workers from excessive heat.

Do you propose action?

NO YES PRIORITY

Remarks

74. Protect workers from cold work environments.

Do you propose action?

NO YES PRIORITY

Remarks

75. Isolate or insulate sources of heat or cold.

Do you propose action?

NO YES PRIORITY

Remarks

76. Install effective local exhaust systems that allow efficient and safe work.

Do you propose action?

NO YES PRIORITY

Remarks

77. Increase the use of natural ventilation when needed to improve the indoor climate.

Do you propose action?

NO YES PRIORITY

Remarks

78. Use air-conditioning systems to provide an indoor climate conducive to the health and comfort of people.

Do you propose action?

NO YES PRIORITY

Remarks

79. Improve and maintain ventilation systems to ensure good workplace air quality.

Do you propose action?

NO YES PRIORITY

Remarks

80. Keep the office work area in good order to increase the efficiency and comfort of people using the area.

Do you propose action?

NO YES PRIORITY

Remarks

81. Provide enough fire extinguishers within easy reach and be sure that workers know how to use them.

Do you propose action?

NO YES PRIORITY

Remarks

82. Recycle wastes to make better use of resources and protect the environment.

Do you propose action?

NO YES PRIORITY

Remarks

83. Mark escape routes and keep them clear of obstacles.

Do you propose action?

NO YES PRIORITY

Remarks

84. Establish evacuation plans to ensure safe and rapid egress from the worksite.

Do you propose action?

NO YES PRIORITY

Remarks

Hazardous substances and agents

85. Isolate or cover noisy machines or parts of machines.

Do you propose action?

NO YES PRIORITY

Remarks

86. Maintain tools and machines regularly in order to reduce noise.

Do you propose action?

NO YES PRIORITY

Remarks

87. Make sure that noise does not interfere with verbal communication and auditory signals.

Do you propose action?

NO YES PRIORITY

Remarks

88. Reduce vibration affecting workers in order to improve safety, health and work efficiency.

Do you propose action?

NO YES PRIORITY

Remarks

.....

89. Choose electric hand-held equipment that is well insulated against electric shock and heat.

Do you propose action?

NO YES PRIORITY

Remarks

.....

90. Ensure safe wiring connections for equipment and lights.

Do you propose action?

NO YES PRIORITY

Remarks

.....

91. Label and store properly containers of hazardous chemicals to communicate warnings and to ensure safe handling.

Do you propose action?

NO YES PRIORITY

Remarks

.....

92. Protect workers from chemical risks so that they can perform their work safely and efficiently.

Do you propose action?

NO YES PRIORITY

Remarks

.....

93. Identify confined spaces requiring entry permits and take adequate control measures to render the space safe for entry and work.

Do you propose action?

NO YES PRIORITY

Remarks

.....

94. Protect workers from biological risks by minimizing exposure to biological agents and isolating potentially contaminated areas.

Do you propose action?

NO YES PRIORITY

Remarks

.....

Welfare facilities

95. Provide and maintain good changing, washing and sanitary facilities to ensure good hygiene and tidiness.

Do you propose action?

NO YES PRIORITY

Remarks

.....

96. Provide drinking facilities and hygienic eating areas to ensure good performance and well-being.

Do you propose action?

NO YES PRIORITY

Remarks

.....

97. Provide rest facilities for recovery from fatigue.

Do you propose action?

NO YES PRIORITY

Remarks

.....

98. Provide easy access to first-aid equipment and primary health-care facilities at the workplace.

Do you propose action?

NO YES PRIORITY

Remarks

.....

99. Provide a place for workers' meetings and training.

Do you propose action?

NO YES PRIORITY

Remarks

.....

100. Clearly mark areas requiring the use of personal protective equipment.

Do you propose action?

NO YES PRIORITY

Remarks

.....

101. Provide personal protective equipment that gives adequate protection.

Do you propose action?

NO YES PRIORITY

Remarks

.....

102. Ensure regular use of personal protective equipment by proper instructions, adaptation trials and training.

Do you propose action?

NO YES PRIORITY

Remarks

.....

103. Make sure that everyone uses personal protective equipment where it is needed.

Do you propose action?

NO YES PRIORITY

Remarks

.....

104. Make sure that personal protective equipment is acceptable to the workers and that it is cleaned and maintained.

Do you propose action?

NO YES PRIORITY

Remarks

.....

105. Provide proper storage for personal protective equipment.

Do you propose action?

NO YES PRIORITY

Remarks

.....

Work organization

106. Solve day-to-day work problems by involving groups of workers.

Do you propose action?

NO YES PRIORITY

Remarks

.....

107. Consult workers on improving working-time arrangements.

Do you propose action?

NO YES PRIORITY

Remarks

.....

108. Involve workers in the improved design of their own workstations.

Do you propose action?

NO YES PRIORITY

Remarks

.....

109. Consult workers when there are changes in production and when improvements are needed for safer, easier and more efficient work.

Do you propose action?

NO YES PRIORITY

Remarks

.....

110. Inform and reward workers about the results of their work.

Do you propose action?

NO YES PRIORITY

Remarks

.....

111. Train workers to take responsibility and give them the means to make improvements in their jobs.

Do you propose action?

NO YES PRIORITY

Remarks

112. Train workers for safe and efficient operation.

Do you propose action?

NO YES PRIORITY

Remarks

113. Provide up-to-date training for workers using computer systems.

Do you propose action?

NO YES PRIORITY

Remarks

114. Provide opportunities for easy communication and mutual support at the workplace.

Do you propose action?

NO YES PRIORITY

Remarks

115. Consider workers' skills and preferences in assigning people to jobs and providing them with opportunities to learn new skills.

Do you propose action?

NO YES PRIORITY

Remarks

116. Set up work groups, each of which collectively carries out work and is responsible for its results.

Do you propose action?

NO YES PRIORITY

Remarks

117. Improve jobs that are difficult and disliked in order to increase productivity in the long run.

Do you propose action?

NO YES PRIORITY

Remarks

118. Combine tasks to make the work more interesting and varied.

Do you propose action?

NO YES PRIORITY

Remarks

119. Set up a small stock of unfinished products (buffer stock) between different workstations.

Do you propose action?

NO YES PRIORITY

Remarks

120. Assign responsibility for day-to-day cleaning and housekeeping.

Do you propose action?

NO YES PRIORITY

Remarks

121. Provide short, frequent pauses during continuous precision or computer work to increase productivity and reduce fatigue.

Do you propose action?

NO YES PRIORITY

Remarks

122. Provide opportunities for physical exercise for workers.

Do you propose action?

NO YES PRIORITY

Remarks

123. Encourage full participation by women and men workers in finding and implementing work improvements.

Do you propose action?

NO YES PRIORITY

Remarks

124. Assist migrant workers to perform their jobs safely and efficiently.

Do you propose action?

NO YES PRIORITY

Remarks

125. Assign appropriate workload, facilitate teamwork and provide adequate training for young workers.

Do you propose action?

NO YES PRIORITY

Remarks

126. Adapt facilities and equipment to workers with disabilities so they can do their jobs safely and efficiently.

Do you propose action?

NO YES PRIORITY

Remarks

127. Give due attention to the safety and health of pregnant and nursing women.

Do you propose action?

NO YES PRIORITY

Remarks

128. Take measures so that older workers can perform work safely and efficiently.

Do you propose action?

NO YES PRIORITY

Remarks

129. Adjust the workplace to the culture and related preferences of workers by taking a user-centred approach.

Do you propose action?

NO YES PRIORITY

Remarks

130. Involve both managers and workers in conducting ergonomics-related risk assessment as part of occupational safety and health management systems.

Do you propose action?

NO YES PRIORITY

Remarks

131. Establish emergency plans to ensure correct emergency operation, easy access to facilities and rapid evacuation.

Do you propose action?

NO YES PRIORITY

Remarks

132. Learn about and share ways to improve your workplace from good examples in your own enterprise or in other enterprises.

Do you propose action?

NO YES PRIORITY

Remarks

Materials storage and handling

CHECKPOINT 1

Clear and mark transport routes.

WHY

Clear transport routes with easy access to worksites and storage areas can really help to achieve a better work flow, as well as ensuring safe and rapid transport.

If transport areas are not clearly marked, materials, work items and wastes tend to pile up on transport routes. These irregular piles not only obstruct transport and production, but can also cause accidents.

Marking of transport routes is the simplest yet most effective method to keep them clear.

RISKS / SYMPTOMS

- poor worksite access
- slips, trips or stumbles
- leg/foot injury
- delayed evacuation

HOW

1. Define transport routes to worksites or between worksites as distinct from storage areas. Consult workers about how to indicate necessary transport routes. Remove obstacles, then install floor markings using paint on both edges of each transport route.
2. Where markings of transport routes are placed near moving machines or stored materials, provide fences or handrails to make movements of workers safe.
3. Make sure that nothing is placed or left on the defined transport routes. Cooperation of everyone in the workplace is necessary. Ensure that there are proper places for storage and waste disposal near worksites. Insist until this practice of placing nothing on the floor is well established.

SOME MORE HINTS

- The provision of storage racks, shelves or pallets should accompany the marking of transport routes. This helps to establish the practice of keeping transport routes clear of obstacles. The provision of waste receptacles is also important.

- There are usually central (or major) transport routes and secondary (or minor) ones in a workplace. Central transport routes should be wide enough to allow busy transport work. Pay attention also to minor transport routes. Always mark all transport routes.
- Sometimes it becomes necessary to rearrange the layout of the work area, as a whole or in part, in order to have shorter and more efficient transport routes. This may require extra effort, but is worth trying.

POINTS TO REMEMBER

Marking transport routes is the starting point for keeping them clear of obstacles. Clear transport routes ensure a good flow of materials and prevent accidents.

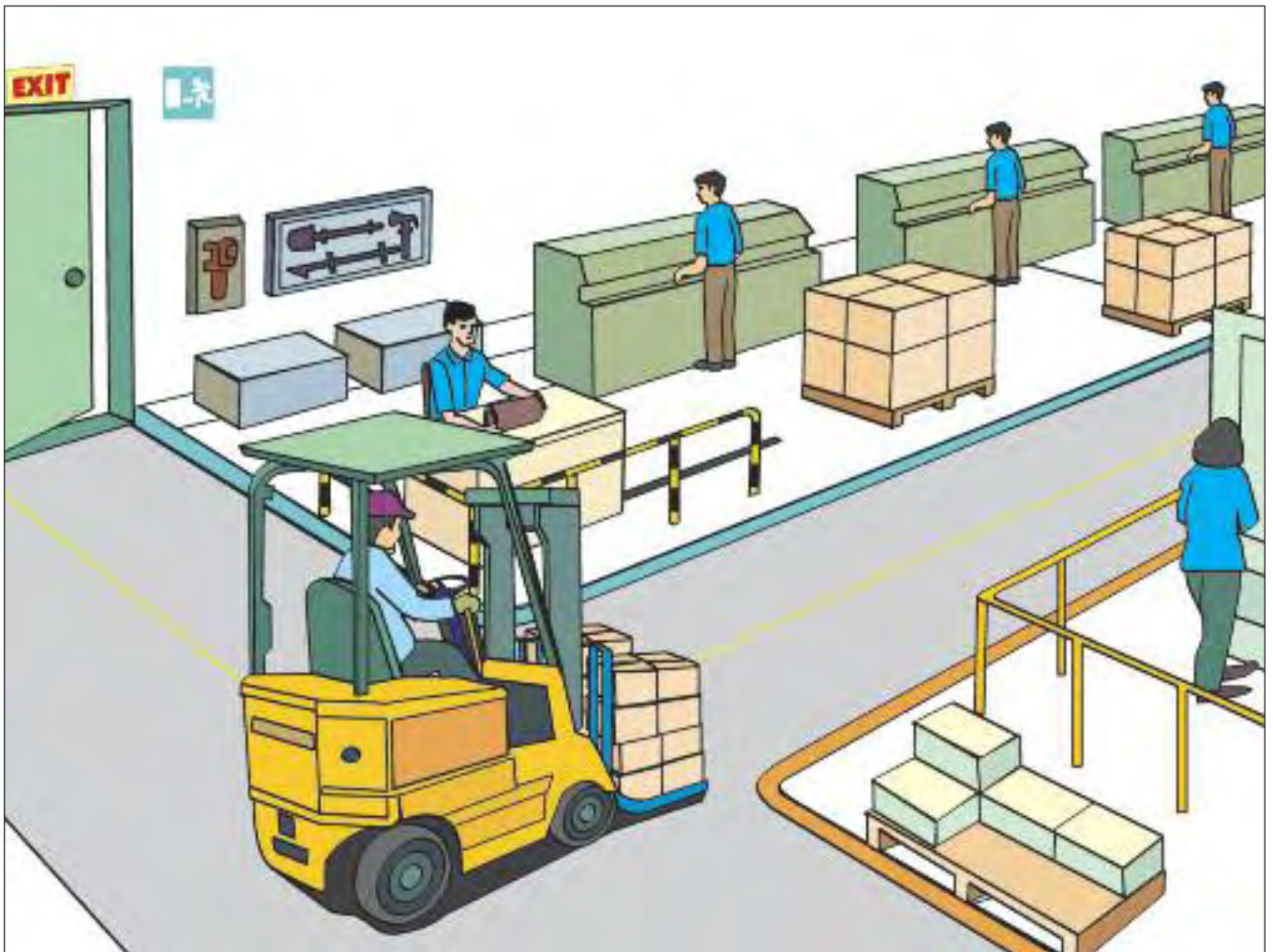

Figure 1. Draw lines to separate transport areas from working areas and keep transport areas clear.

CHECKPOINT 2

Keep aisles and corridors wide enough to allow two-way transport.

WHY

Aisles and corridors free from obstacles are important for the smooth movement of materials and workers. Passageways that are too narrow or that have obstacles placed in them greatly hamper the flow of work and cause considerable loss of time.

Smooth two-way transport is a minimum requirement for any aisle or corridor, and can help good work flow and prevent accidents. There should be very few exceptions to this rule (e.g. dead-end corners of small storage areas that are only occasionally used).

Aisles and corridors wide enough to allow the passage of pushcarts greatly facilitate efficient production, as fewer and safer transport operations become possible.

RISKS / SYMPTOMS

- poor worksite access
- slips, trips or stumbles
- leg/foot injury
- delayed evacuation

HOW

1. Clear aisles and corridors of obstacles so that smooth passage is always possible. Mark aisles on both sides.
2. Make aisles for transport of materials wide enough (at least 125–140 cm) to allow for two-way transport. Minor passageways where transport is infrequent can be at least 75 cm, but keep such exceptions to a minimum.
3. Check that mobile racks and pushcarts can easily pass through the aisles and corridors.
4. Where two-way transport is not possible (e.g. because of space constraints despite frequent transport), consider alternative easier ways to transport materials and semi-products, such as

the use of easy-to-carry pallets, small trays or detachable shelves that can be placed on pushcarts after arriving at two-way aisles.

SOME MORE HINTS

- Where possible and appropriate, place fences or partitions around transport routes in order to ensure they are always free for easy passage.
- Mobile racks or pushcarts can greatly improve the efficiency of transport. If their use is hampered by narrow aisles, try to introduce arrangements (such as relocation of machines) to improve their smooth passage.
- Corners in passageways can create congestion. Make turning around corners smooth by allowing sufficient space.
- In order to avoid placing materials in aisles and corridors, provide racks, side-stands and shelves so that it is easier for people to respect the rule of not placing materials on the floor.

POINTS TO REMEMBER

Easy two-way transport through aisles and corridors saves time and energy, and helps to keep the workplace in order.

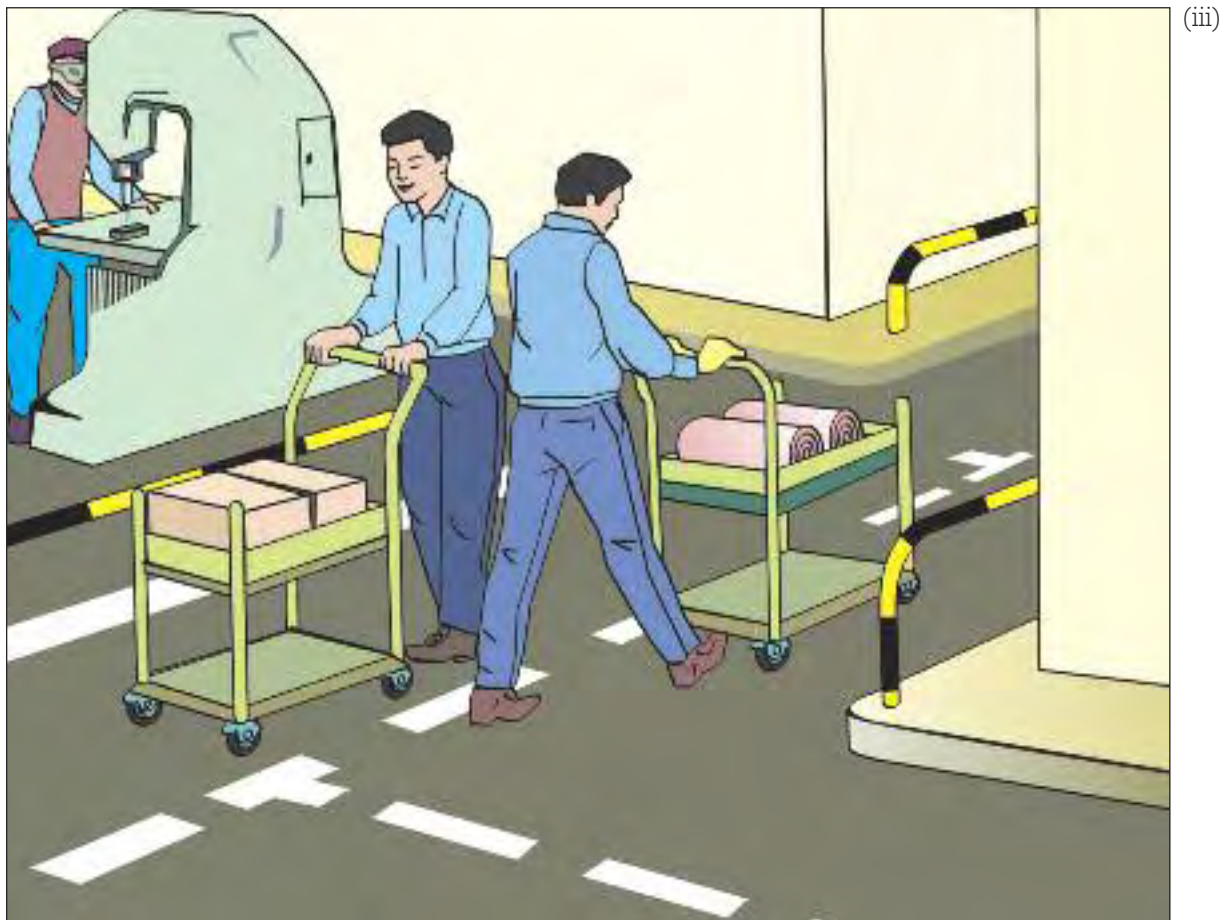
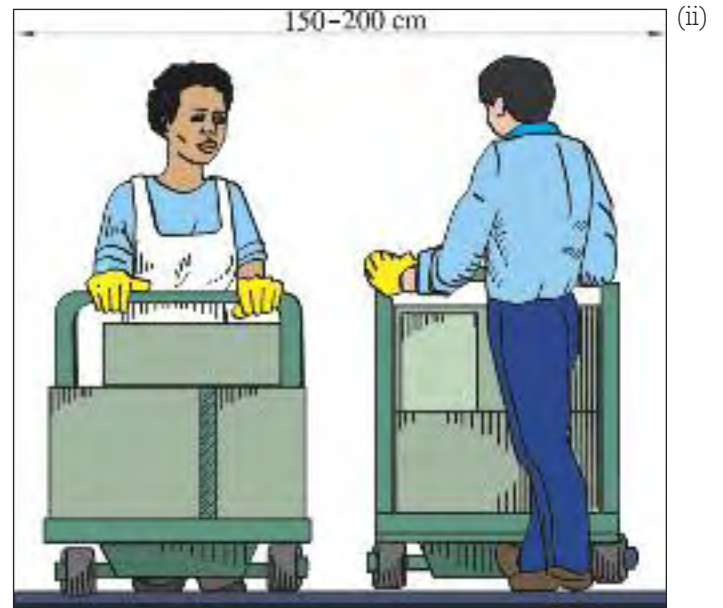

Figure 2. (i), (ii) and (iii) Keep aisles and corridors wide enough to allow two-way transport.

CHECKPOINT 3

Make the surface of transport routes even, not slippery, and without obstacles.

WHY

Transport within the enterprise is an important part of day-to-day work. The smooth flow of transport from the storage area to worksites, and between workstations, is a prerequisite for a productive workplace.

Carrying loads on an uneven or slippery floor is a common cause of accidents. Such accidents can be eliminated by arranging good transport routes.

Products may fall when workers stumble or hit obstacles, thus causing loss of production or increased repair costs.

The use of carts and wheeled racks is considerably easier if the surface is even and free from obstacles.

RISKS / SYMPTOMS

- slips, trips or stumbles
- muscular strain
- excessive force
- serious injury or accident

HOW

1. Remove sudden height differences or other stumbling hazards in transport routes.
2. Make it a routine to remove or avoid spilt water, oil or other slippery substances (by cleaning, laying easy-to-clean floor surfaces or using absorbent materials). Use covered transport containers to avoid spills.
3. If uneven spots cannot be removed immediately, use ramps, fill-ins or loading platforms.
4. Make it a rule to place nothing in the aisles or corridors. This is best done by providing sufficient numbers of storage areas, racks and waste receptacles, and by defining and marking transport routes.

5. Promote the use of transport devices including carts, mobile racks, trolleys and small vehicles. Large wheels are preferable to small ones except for short-distance transport on hard, even surfaces.

SOME MORE HINTS

- Transport surfaces can be covered or painted with high-friction coatings, which reduce the risk of slipping but do not affect the rolling resistance of carts and trucks. Such surfaces may, however, be more difficult to clean.
- Painting transport surfaces in bright colours makes it easy to identify slipping risks. Adequate lighting helps to identify unevenness.
- Unsuitable or low-friction footwear may cause slipping, even on good surfaces. If the slipping risk is considerable, provide workers with suitable footwear.

POINTS TO REMEMBER

Cleaning of transport routes is a low-cost solution to potential problems. Make cleaning a daily routine.

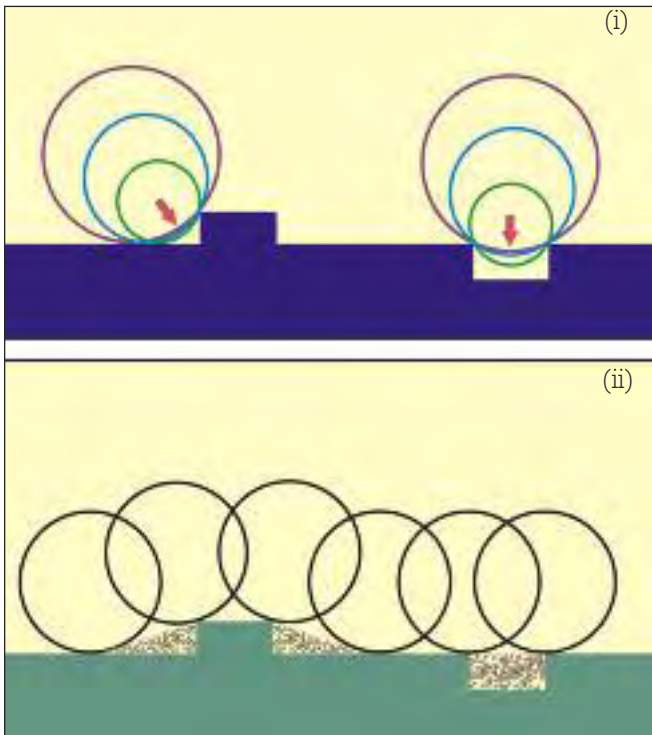

Figure 3a. (i) Remove sudden height differences wherever possible. Larger wheels are generally better than smaller ones as they can more easily overcome any obstacles or hollows there might be. (ii) Fill in or bridge sunken areas. If height differences remain, provide gradually inclined covers so as to avoid stumbling or wheel obstacles.

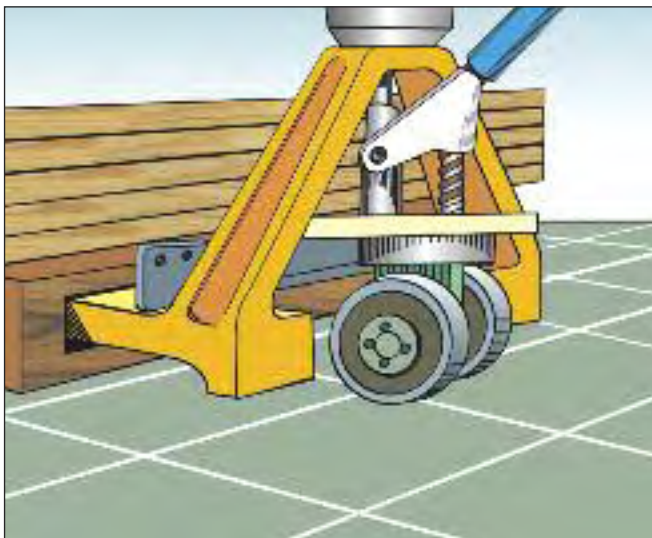

Figure 3c. Flooring should be as complete as possible, to eliminate stumbling obstacles or sunken areas.

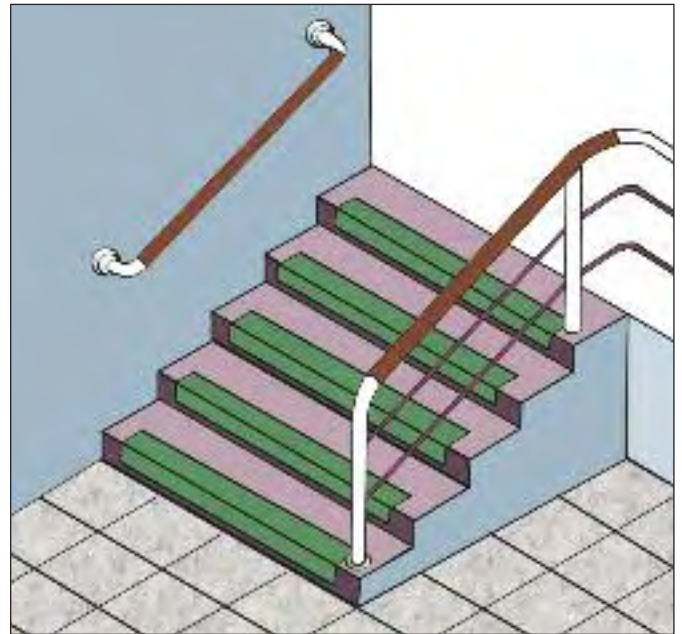

Figure 3b. Make arrangements to prevent slipping on slopes or stairs. High-friction materials placed at the edges of stairs can help.

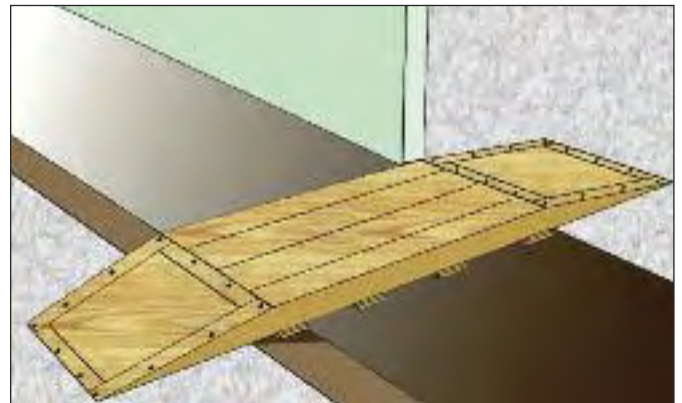

Figure 3d. Where bridging is necessary, make sure that the surface is not slippery and allows the passage of wheels.

CHECKPOINT 4

Provide ramps with a small inclination instead of small stairways or sudden height differences within the workplace.

WHY

Sudden height differences in passageways within the workplace hamper smooth transport of materials and can cause accidents. Instead of posting "MIND THE STEPS" notices here and there, provide ramps to eliminate the hazard.

Short stairways with only a few steps may seem easy to climb up and down, but can cause stumbling or falling, which may lead to accidents and damage to products. It is worth considering the use of ramps instead of stairs.

Ramps with a small inclination make it possible to use pushcarts and wheeled racks, which greatly facilitate the transport of work items.

RISKS / SYMPTOMS

- slips, trips or stumbles
- muscular strain
- excessive force

HOW

1. Where there are small, sudden height differences or stairways with just a few steps, replace them by a ramp with a small inclination (up to 5 to 8 degrees).
2. If disabled access is required, the inclination should be appropriately designed for wheelchair access.
3. Make sure there are no stumbling obstacles on entering or leaving the ramps provided. Also ensure that the surface of the ramps is adequate and non-slippery.
4. If there is a danger of falling from the side of the ramp, provide fences or handrails.
5. Encourage the use of carts and mobile racks instead of manual carrying of materials and semi-products. Ramps are perfectly suited for these.

SOME MORE HINTS

- Avoid slippery ramp surfaces. Make sure that ramp surfaces do not get wet.
- When carts or mobile racks are used, provide firm grips or handles to ensure easy and safe transport on ramps.
- Check the workplace layout and means of transport so as to reduce the frequency of transport, especially when transport is necessary between workplaces with height differences.

POINTS TO REMEMBER

Ramps can prevent stumbling and facilitate transport operations. They lead to fewer and safer transport trips through the use of pushcarts or mobile racks.

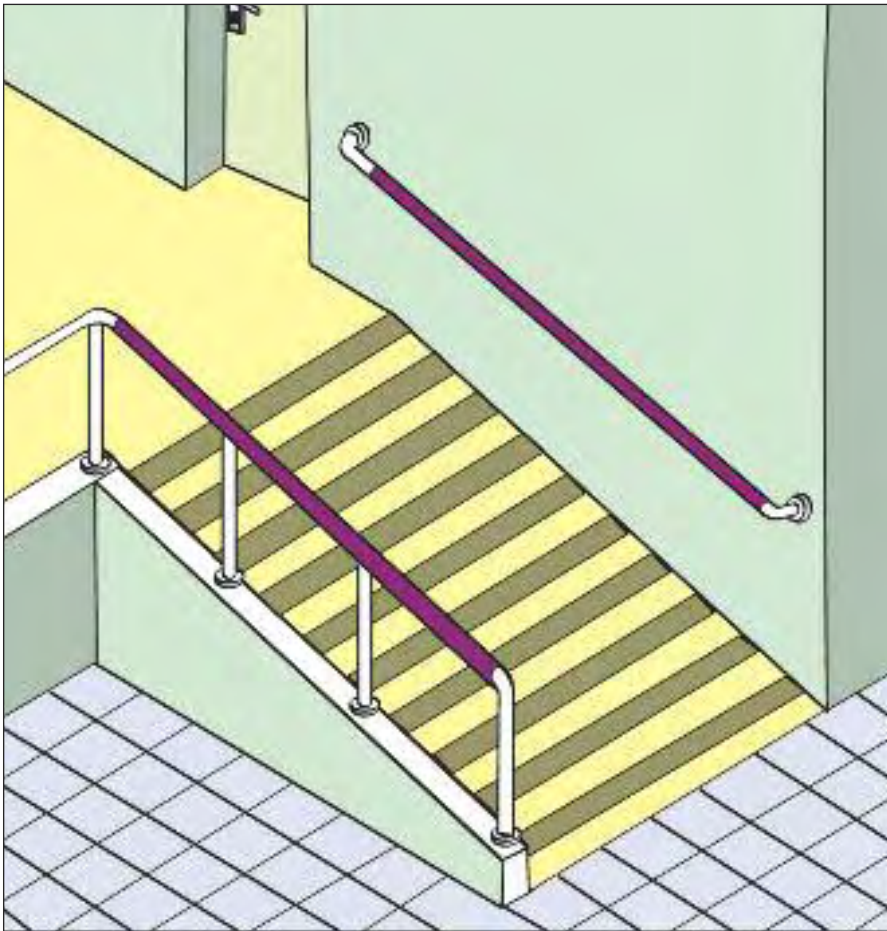

Figure 4. Provide ramps instead of stairways.

CHECKPOINT 5

Improve the layout of the work area so that the need to move materials is minimized.

WHY

Machines and workstations are often installed one after another as production expands, and their existing positions are not necessarily suitable for easy and efficient movement of materials. This can be improved by changing their layout.

Time needed to perform a task can be greatly reduced by reducing the movement of materials. This reduces workers' fatigue, allowing more efficient working.

This is also beneficial for preventing accidents caused by moving materials.

RISKS / SYMPTOMS

- physical energy demand
- repetitive strain
- excessive fatigue
- low back pain
- increased injury rates
- stress-induced disorder

HOW

1. Discuss with workers how the frequency and the distance of moving materials can be reduced by changing the layout of machines and workstations. There could be a better way of moving materials within work areas and between different work areas.
2. Arrange a series of several workstations close to one another to minimize the movement of work items between each workstation.
3. Arrange different departments according to the sequence of work done so that work items coming from one department can be utilized by the next without moving them over a long distance.
4. Combine operations whenever possible in order to reduce the need to move materials between operations.

SOME MORE HINTS

- Use pallets or a batch of work items so that multiple items coming from one workstation can be moved easily to the next workstation or work area.
- Ensure that transport routes are clear when rearranging the layout of the work area.
- A flexible work area layout that can be adapted to changes in work flow (for example, because of product changes or in order to produce several different products) is a productive layout.

POINTS TO REMEMBER

Minimizing the need to move materials by improving the layout of the work area is the surest way to reduce time and effort, and increase productivity.



Figure 5a. Provide stock shelves or racks so that work items coming from one workstation can go directly to the next one.



Figure 5b. Rollers or conveyers can reduce the distance materials have to be moved manually. The height should be such that the work item can be handled without bending the upper body. Make sure there is enough space for the feet and body to get close to the rollers or conveyers.

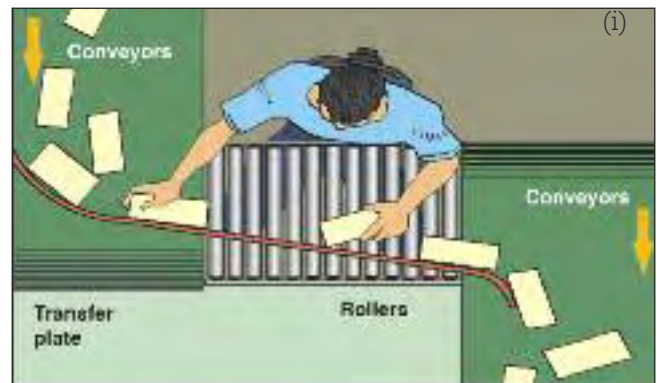

Figure 5c. (i) and (ii) Provide a layout that allows the worker to move objects from one conveyor to the next while keeping a natural posture. Using a transfer plate and rollers makes it easier to move objects.

CHECKPOINT 6

Use carts, hand-trucks and other wheeled devices, or rollers, when moving materials.

WHY

Moving many materials not only takes a lot of effort, but also often leads to accidents that may injure workers and damage materials. All this can be avoided by using "wheels".

By using carts and other mobile devices the number of trips can be significantly reduced. This means improved efficiency and safety.

Rollers placed one after another along a materials movement line greatly ease the movement of materials because only the pushing and pulling of rollers is needed instead of carrying.

RISKS / SYMPTOMS

- muscular strain
- excessive force
- low back pain
- upper limb disorder

HOW

1. Check movements of materials between storage and work areas, and between workstations, especially when these movements of materials are frequent or require a lot of effort. Consider the use of carts or "wheels" to make these movements easier.
2. Design simple pushcarts of appropriate size for carrying materials. Construct such carts using available parts and skills.
3. Provide a line of rollers on which materials can be pushed easily to the next workstation. A 2 m long roller line can be a great help.
4. Use pallets, bins or containers that can be loaded easily onto a pushcart or pushed through on rollers. Design special ones for different products so that products are protected from damage, and are easy to count and inspect.

SOME MORE HINTS

- It is important to have clear transport routes, free from obstacles at all times. Clear transport routes are essential for moving around with a cart.
- Materials can be moved between workstations by conveyers, rollers, gravity chutes, suspended cranes, mobile hoists and other devices. There are many ways to construct such systems at low cost.
- A long, rectangular, mobile frame on which rollers are placed one after another could also be used for loading and unloading trucks.
- Choose wheels of a larger diameter, especially when moving materials a long distance or on uneven surfaces.
- If possible, use rubber wheels or castors to reduce noise.

POINTS TO REMEMBER

Reduce the number of trips between workstations and between storage and work areas by using wheeled transport such as pushcarts, or roller lines.

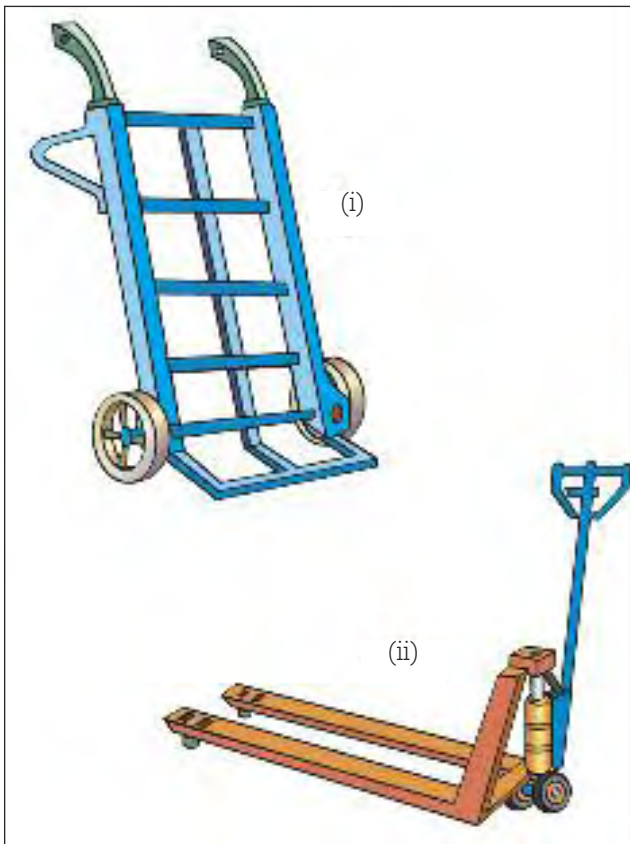

Figure 6a. (i) A heavy-duty sack truck and (ii) a low-lift pallet trolley are reliable, safe and easy to operate. They provide means of carrying heavy loads a short distance with minimum elevation.

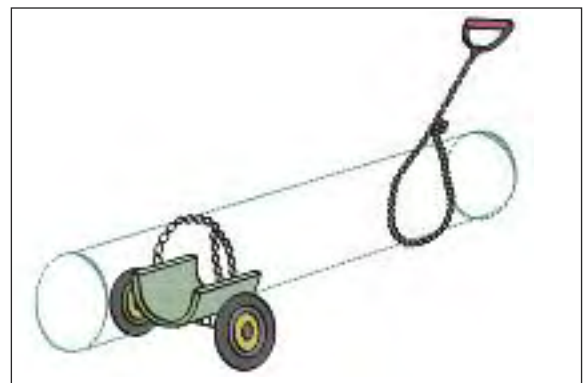

Figure 6b. This small cart enables one worker to move heavy metal bars.



Figure 6c. This barrel-handling device not only makes work much easier but also helps avoid damage.



Figure 6d. A passive conveyor line for moving heavy motor castings at working height.



Figure 6e. An easy-to-move tool cart provides orderly storage and protection of tools and instruments.

CHECKPOINT 7

Use mobile storage racks to avoid unnecessary loading and unloading.

WHY

There are usually a large number of items that need to be carried to other workstations or to storage areas. If these items are put on mobile racks and the racks are then moved to the next place, many unnecessary trips can be avoided.

Carrying work items together on mobile racks means fewer materials-handling operations (such as loading and unloading). This helps to reduce damage to work items, minimize accidents, and use workers' energy for productive operations.

Using mobile racks also means easy inventory control and more efficient housekeeping.

RISKS / SYMPTOMS

- muscular strain
- repetitive strain
- physical energy demand
- product damage

HOW

1. Design or purchase racks, containers, stands, etc. that have wheels and foot locks where appropriate. It is then possible to move a number of items at a time. Choose racks that are easy to load and unload.
2. Arrange the workplace layout to allow the smooth movement of wheeled racks between workstations, and between storage and work areas. If necessary, redefine transport routes.
3. When many small items are to be moved, provide adequate space for each item so that all items can be placed neatly on the mobile rack.
4. Consider the use of pallets, containers, trays or bins that can be placed on a mobile rack or a pushcart.
5. Fit wheels to existing stands, racks or workbenches in order to make them mobile and thus avoid unnecessary loading and unloading operations.

6. Consider where to store the racks when not in use so that they are not a hazard or obstruction.

SOME MORE HINTS

- If designing effective mobile racks seems complicated, a good first step may be to design pallets or trays to move several items at the same time. This experience will make it easier to design a rack that is both easy to handle and efficient.
- When many similar racks are used, standardize them. Similarly, when many pallets or containers are used for work items, standardize them so that they can be easily placed on a mobile rack or cart. It is even better if these pallets or containers can be stacked.
- Maintenance of wheels or rollers is very important because it makes pushing and pulling easier.
- It is worth investing in the design of special-purpose mobile racks for particular work items, even though that might require money and effort. Such racks are extremely helpful for improving productivity. The racks enable many items to be placed on the rack by easy handling operations and moved conveniently to other worksites.

POINTS TO REMEMBER

Mobile storage racks are an ideal answer to reducing handling operations and transport time.

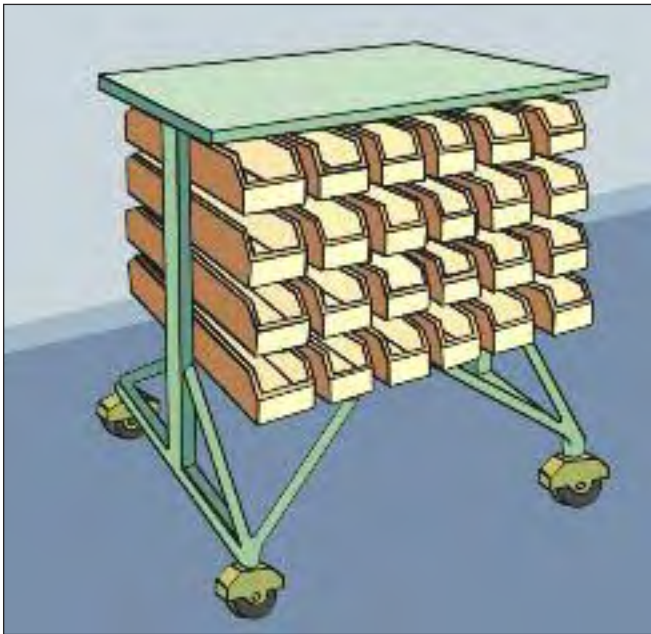

Figure 7a. A mobile bin cart helps to ensure smooth work flow in assembly shops where numerous operations are performed at each workstation.

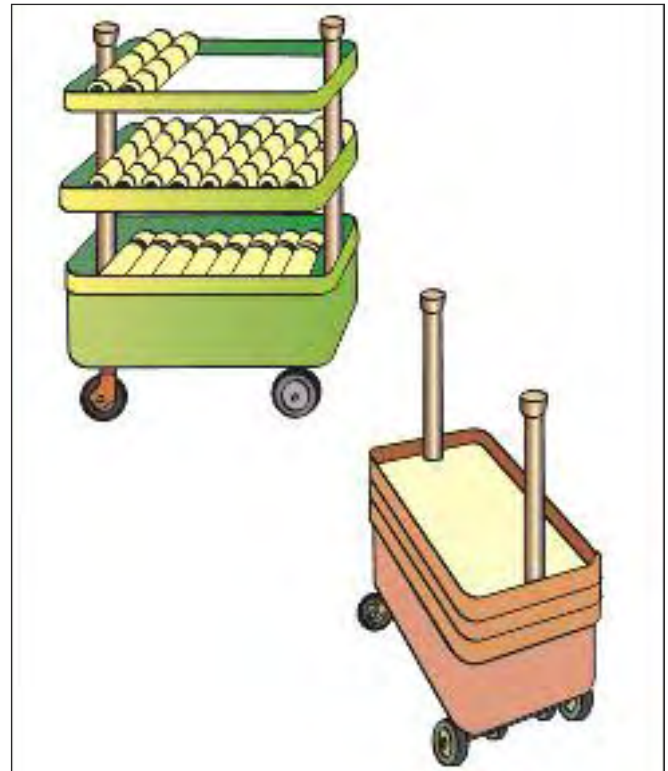

Figure 7b. A tool trolley with adjustable shelves occupies little space, but contributes much to improving the efficiency of motor mechanics and machine or tool repair workers.



Figure 7c. A rack on wheels specially designed for storage and handling of motorcycle silencers.

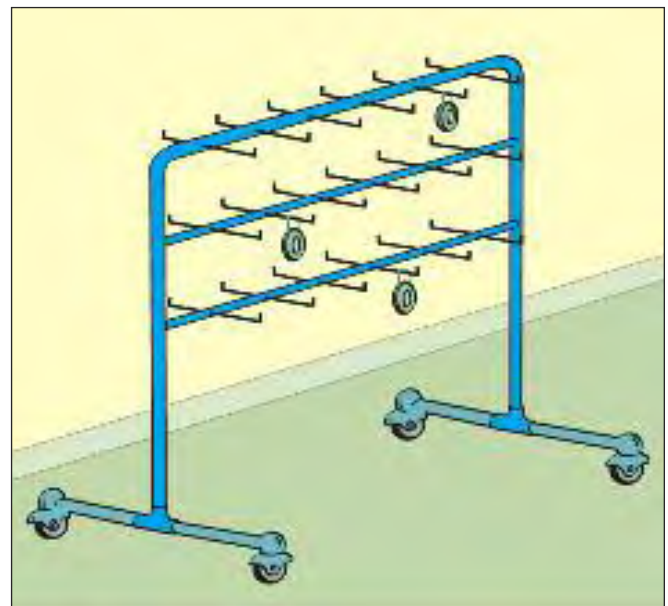

Figure 7d. A flat, two-sided movable rack, a real “space saver” for a small factory with narrow passages, can be successfully used in many types of workplace.

CHECKPOINT 8

Use multi-level shelves or racks near the work area in order to minimize manual transport of materials.

WHY

Placing materials near the workstation, so they are easy to access and at an appropriate height, can save time and energy spent in picking them up.

Multi-level shelves and racks allow better use of space and help to keep things in good order when space available near the work area is limited.

Shelves and racks with space specified for each individual item are excellent for safe storage of materials and semi-finished products, especially fragile ones; this reduces the danger of accidents and fires, and the possibility of damage.

RISKS / SYMPTOMS

- excessive reach
- muscular strain
- excessive force
- product damage

HOW

1. Provide multi-level, open-fronted shelves or racks for various specific items.
2. Make full use of wall space by fitting multi-level shelves or racks to the wall near the work area.
3. Wherever possible, make racks movable by fitting them with wheels.
4. Provide a different, specially arranged place for each kind of material or part so that access to them, as well as their stocking and transport, is easy; use labels or other means to indicate each specific place. Avoid levels that are too high or too low because they can be difficult to reach.

SOME MORE HINTS

- Use lightweight containers and bins for storage of small parts. Front-opening containers and bins make it easy to see and grasp the materials and parts inside.

- Use pallets or trays with individual spaces for each specific item for easy storage, easy access and easy stocking.
- Store heavy or awkward items at waist height or in a way appropriate for the next stage of transport; store light and infrequently used items at knee or shoulder level.
- When accessing racking above head height use a platform step or platform ladder. Avoid carrying items using two hands when climbing down a ladder. Three points of contact for the hands and feet must be retained for safety, to avoid the risk of falling.

POINTS TO REMEMBER

Multi-level shelves and racks on wheels keep things in order and save a great deal of time and space. This is a simple yet clever way of reducing damage to materials and of avoiding accidents.

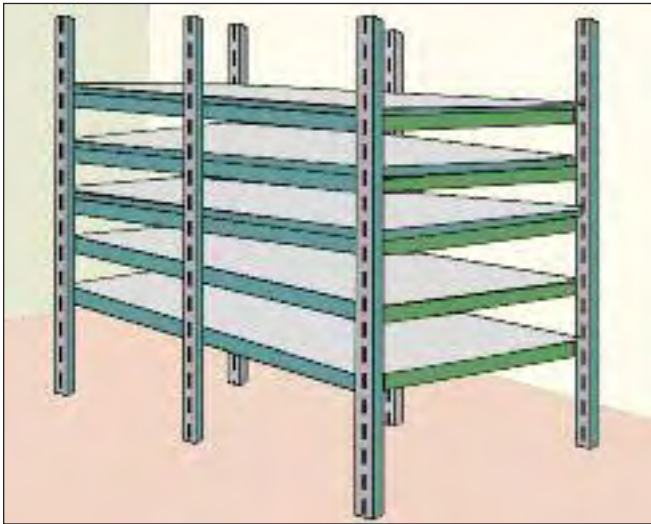

Figure 8a. A multi-level horizontal storage rack for metal sheets or plywood. Remember to keep everything dry, otherwise water tends to spread between the sheets and damage them.

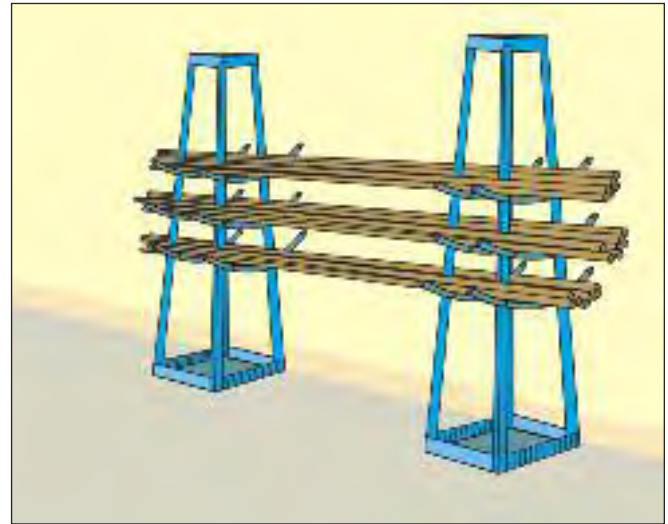

Figure 8b. A horizontal bar rack. This free-standing unit may be used singly to store short pieces, or two of these racks may be placed in line to store long pieces.



Figure 8c. A vertical rack. Metal rods and bars of different profile can be stored efficiently in a limited area or near the job. Tray-type shelves provide room for small pieces.



Figure 8d. Shelving designed to make full use of wall space.

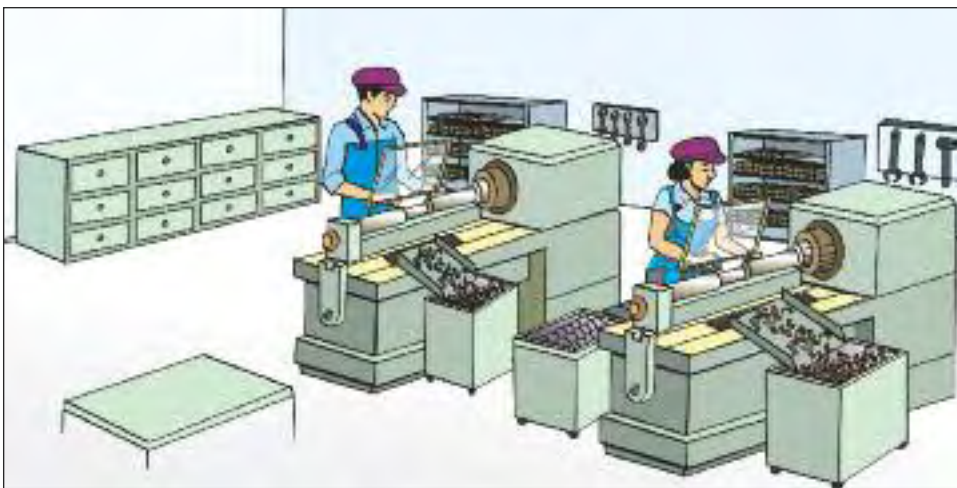

Figure 8e. A shop floor after removal of all unnecessary items. All tools and parts are stored on shelves and racks.

CHECKPOINT 9

Use mechanical devices for lifting, lowering and moving heavy materials.

WHY

Manual lifting, lowering and moving of heavy materials and work items are some of the major causes of accidents and back injuries associated with materials handling. The best way to prevent these accidents and injuries is to eliminate the manual work by using mechanical devices.

Lifting and carrying heavy objects manually requires skill and takes a lot of time. Select a lifting device that is easy and quick to use.

Introducing mechanical devices to handle heavy materials greatly helps to organize the work flow.

RISKS / SYMPTOMS

- muscular strain
- excessive force
- physical energy demand
- low back pain

HOW

1. Install floor-based lifting devices that use the minimum elevation necessary. Examples are gantries, hydraulic lifting devices, lift-tables, hydraulic floor cranes, lever or chain hoists, electric hoists, and conveyers.
2. Overhead cranes and overhead hoists can be used if the workplace structure permits them. However, take into account that these overhead devices can introduce a hazard to the workplace that may result in serious accidents. Floor-based lifting devices are preferable because they require less elevation of materials.
3. Only use lifting machinery that has been tested by the manufacturer or some other competent person, and which has a certificate specifying the safe working load.
4. Make sure that the maximum safe working load is plainly marked and that it is observed.

5. Make sure that qualified persons regularly inspect and maintain lifting machines, chains, ropes and other lifting tackle.

SOME MORE HINTS

- Manual lifting of heavy loads should be considered as a last resort in special cases when the application of mechanical means is not feasible.
- Lifting heavy loads is usually combined with transport. Organize the lifting so that the next step of transport is easier. Lifting to the working level on a mobile lift-table is a good example.

POINTS TO REMEMBER

Use mechanical lifting devices for the minimum elevation necessary for safety and efficiency.



Figure 9a. A portable gantry is reliable, safe and easy to operate for carrying a heavy load a short distance with minimum elevation.

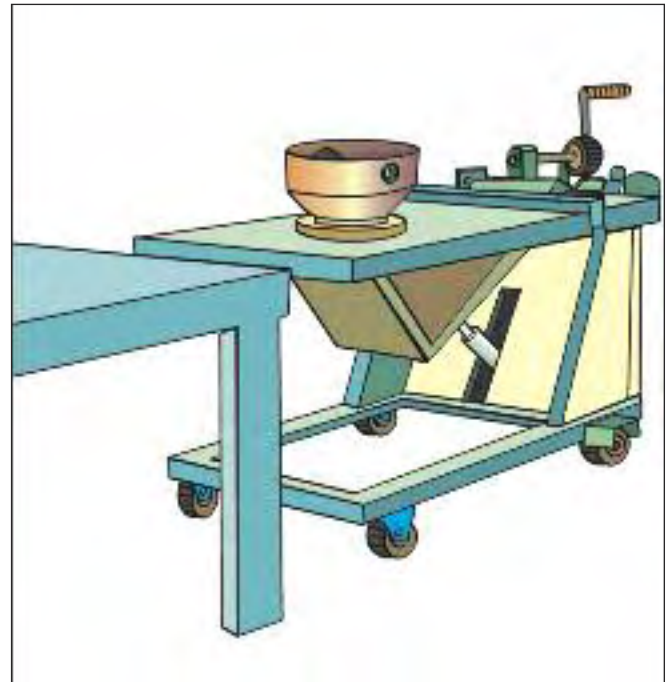

Figure 9b. A manually powered device for lifting heavy castings to working level.



Figure 9c. A manually powered hydraulic floor crane with a telescopic boom.



Figure 9d. Make sure that the maximum safe working load is plainly marked.

CHECKPOINT 10

Reduce manual handling of materials by using conveyers, hoists and other mechanical means of transport.

WHY

Manual handling of materials, including stocking, loading and unloading, does not add any value or profit. By replacing it with mechanical means, workers can use their time for productive work. This is true for both heavy objects, and light and small objects.

Repetitive manual handling of materials leads to bad working postures and frequent awkward movements. This may cause muscle and joint problems, resulting in poor productivity. Using equipment instead of manual handling greatly reduces fatigue and the risk of injury.

Mechanical transport of materials greatly improves productivity and so makes it possible to organize a better work flow.

RISKS / SYMPTOMS

- excessive force
- muscular strain
- repetitive strain
- physical energy demand

HOW

1. Check materials-handling operations to see which of them can be replaced by mechanical means.
2. Use manually powered devices, such as hydraulic lift-tables, hydraulic floor cranes, or lever or chain hoists. These are easier to maintain than power-driven devices.
3. Where manually powered devices cannot deal properly with heavy materials, use power-driven devices such as electrical or hydraulic lifts, conveyers or suspension lines. These devices often make it possible to organize automatic transport of materials to the next workstation.
4. If a mechanical mover is impractical, use a gravity chute for light materials and an inclined roller conveyer for heavy materials. The force of gravity takes care of moving the materials.

5. Train workers in safe procedures for using the mechanical means of transport. Also make sure there is enough space for safe operations.
6. Make sure that the dangers presented by new mechanical devices are evaluated properly and that adequate countermeasures are taken.

SOME MORE HINTS

- Use mechanical devices that can be easily operated by different workers for different handling tasks. This facilitates use of the devices.
- Install the mechanical devices so that manual work prior or subsequent to mechanical handling is easy, e.g. so that the worker need not lift or lower the materials any further.
- Use a pushcart or trolley whereby the materials can be brought to the stocking or unloading point at the right height. If appropriate, consider the use of a special stand or platform of the right size and correct height placed near each machine. Materials carried to the machine can be easily stocked on such a stand or platform.
- Transport and supply of toxic or dusty material require special attention. Do not transfer materials to areas where workers are eating.
- Learn from good examples already in use on similar machines. There should be many simple and practical ideas.

POINTS TO REMEMBER

By using mechanical means of transport, the worker's productive hands and energy are released from handling materials and made available for profitable and safer tasks.



Figure 10a. Mechanical transport of materials can both eliminate manual work and improve work height and working posture.

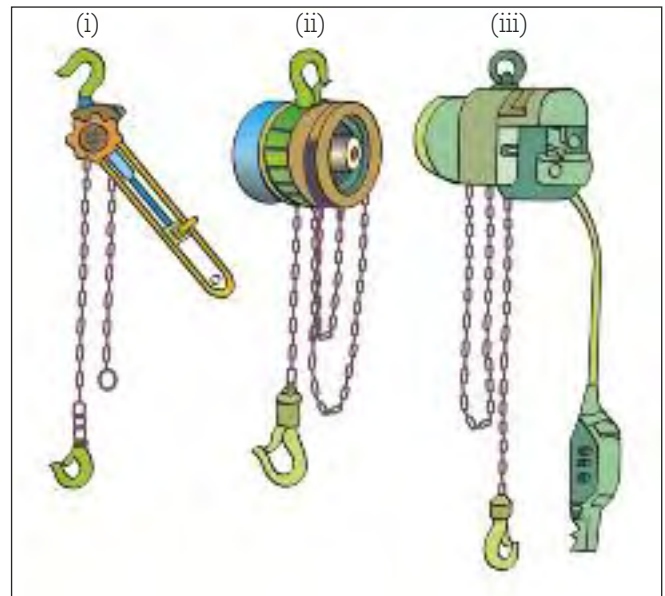

Figure 10b. (i) A lever hoist is simple to operate and extremely versatile. (ii) A chain hoist with a self-activating load brake. (iii) An electric chain hoist with butterfly control switch for efficient handling of lighter loads.



Figure 10c. Reduce manual handling of materials by using conveyers.

CHECKPOINT 11

Instead of carrying heavy weights, divide them into smaller lightweight packages, containers or trays.

WHY

Carrying heavy items is strenuous and dangerous. Divide heavy loads into smaller objects whenever possible. Half the load carried by each arm gives good balance, allowing the worker to continue longer with less fatigue. A one-sided load can cause injuries and back, shoulder and neck disorders.

The fatigue from carrying lightweight packages is much less than the fatigue from carrying heavy weights. The worker's productivity is improved by carrying lighter packages.

The risk of back injuries is also greatly reduced by using light instead of heavy packages.

RISKS / SYMPTOMS

- muscular strain
- excessive force
- low back pain

HOW

1. Check all manually lifted or carried weights to see if there is a possibility of dividing them into smaller loads.
2. Divide heavy loads into lighter packages, containers or trays, considering the maximum weight with which the worker is comfortable. For example, two packages of 10 kg each are far better than one package of 20 kg.
3. When loads are divided into smaller packages, this may mean increased movements and more trips to carry the same total amount. Therefore be sure that packages are not too small, and that effective means of moving or carrying these smaller packages are used.
4. Use carts, trolleys, mobile racks or hand-trucks to carry multiple packages at a time. This is in line with the idea of dividing heavy packages into

smaller ones, as the total amount carried by carts, etc. does not decrease overall, although loading and unloading are easier and faster.

SOME MORE HINTS

- Organize the use of transport devices by studying the situation jointly with workers in order to avoid manual carrying whenever possible.
- Ensure that packages have good hand grips so that the load can be kept near the waist while carrying.
- Smaller objects make it easier to organize the workplace in terms of materials flow and storage. They also reduce accidents such as dropping or stumbling.
- Make sure that transport routes are even, not slippery, and without obstacles.

POINTS TO REMEMBER

A lighter weight is a safer weight. Divide heavy weights into lightweight packages to improve safety and efficiency at work.

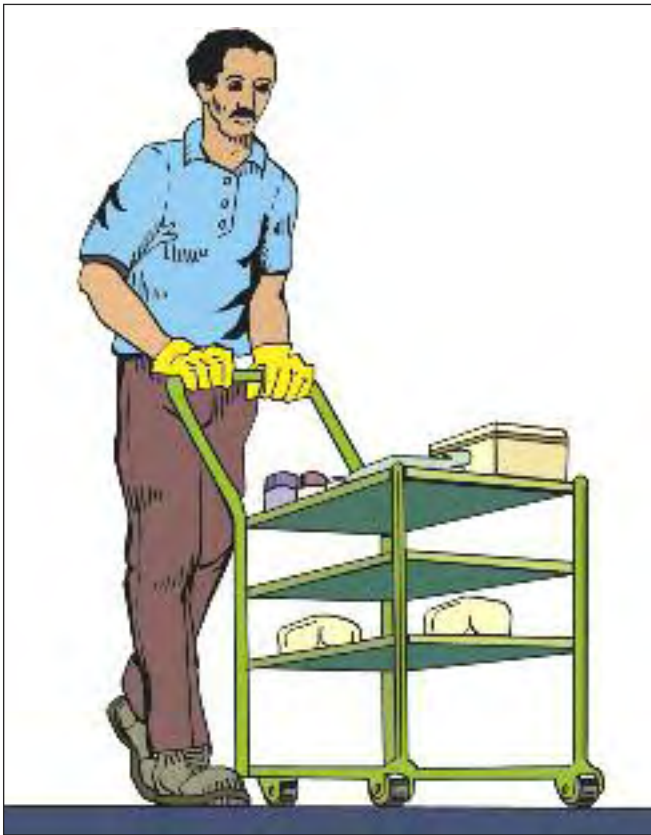

Figure 11a. Divide heavy packages into smaller lightweight ones.

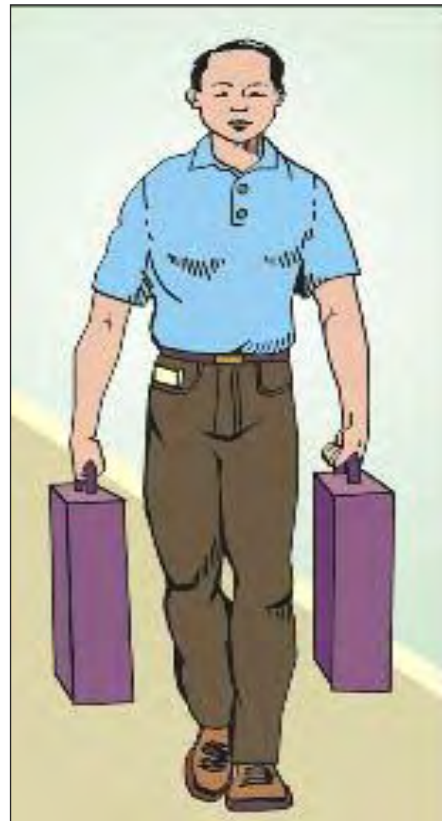

Figure 11b. Divide heavy items into smaller objects whenever possible.



Figure 11c. A yoke or a similar device is useful for carrying two separate loads for some distance while keeping balance and minimizing the lifting or lowering work.

CHECKPOINT 12

Provide handholds, grips or good holding points for all packages and containers.

WHY

Carrying loads is much easier and quicker if they can be grasped easily and firmly.

With good grips there is less chance of dropping the loads, and thus damage to materials is prevented.

Good hand grips also provide a clear forward view.

Good handholds reduce fatigue, because there is less bending of the body and less muscle power required to hold the load.

RISKS / SYMPTOMS

- muscular strain
- hand/arm injury
- upper limb disorder

HOW

1. Cut out handholds in boxes, trays and containers so that they can be comfortably carried by hand.
2. Use packages that have a grip or good holding points for carrying.
3. Ask suppliers and subcontractors to deliver goods in boxes or containers with handholds or grips.
4. Locate handholds so that the load can be carried in front of the body.
5. When a load is carried by means of one handhold or grip, locate it so that the centre of gravity of the load is close to the worker's body.

SOME MORE HINTS

- Make it a rule to order boxes, trays and containers that have handholds or grips.
- Consider putting the handhold at an angle by which the box or container can be carried with the wrist in a comfortable, straight position.

- Packaging should be designed to simplify manual handling (for example, in lightweight packages) and to provide grips or good holding points. Slippery package surfaces should always be avoided.
- Be aware that the worker may be wearing gloves. Grips or handholds must be easily grasped by gloved hands.

POINTS TO REMEMBER

Fitting handholds on boxes and containers is a very simple measure to improve materials handling.

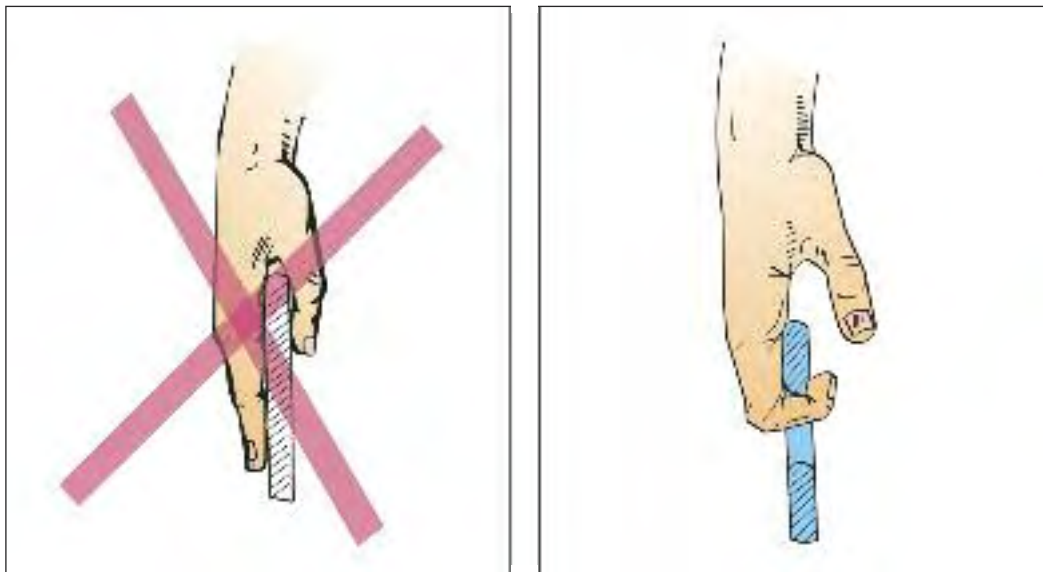

Figure 12a. Handholds should be cut out so as to allow the container to be gripped by bent fingers. This can greatly reduce the force needed to hold the container.



Figure 12b. Cut-out handholds are very useful. Locate these handholds so that the box or container can be carried in front of the body.

CHECKPOINT 13

Move materials horizontally at the same working height.

WHY

Pushing and pulling are less strenuous and safer than lifting and lowering materials, particularly heavy items.

Horizontal movement of heavy materials is more efficient and allows better control of work, because the work requires less force and the worker does not need to move the weight of the body.

Pushing and pulling at appropriate height, rather than lifting, helps prevent back injuries.

RISKS / SYMPTOMS

- repetitive strain
- muscular strain
- low back pain

HOW

1. When materials are moved from one workstation to another, move these materials at the working height. For example, move between work surfaces of the same level.
2. If large items are placed on the floor, use a yoke, sack, hand-truck or low-level pallet trolley to carry them with minimum elevation.
3. Use transport systems which mean that materials can be moved without a change of height. Examples include a passive conveyer line (using rollers placed at the same level), a mobile work-stand or trolley that is of the same height as the work tables, or suspension of materials that move at the same level.
4. Match the height of the vehicle bed to that of the loading area, so that loading and unloading can be done with minimum height differences.
5. Ensure there is enough space for the feeding and unloading positions at the machine so that gliding or sliding of heavy, repeatedly handled objects can be done easily. Note that an even and non-slippery floor surface is important for efficient and safe work.

6. Use simple lifting devices or mobile lift-tables to move the load to the feeding or workbench level.

SOME MORE HINTS

- Avoid handling of heavy materials in confined spaces as this limits the efficiency of moving and may cause bad posture and accidents.
- Pushing or pulling is more efficient when it is done forwards and backwards rather than from side to side in relation to the body.
- When moving heavy work items from one workstation to the next, keep them at a working height so that there is no need for raising or lowering movements.
- Use work-stands or platforms to place materials so as to reduce height differences in moving these materials.
- Build special materials-handling devices adapted to your work items that allow a minimum of elevation of the load. Examples are cylinder-carrying hand-trucks, barrel-carrying pushcarts or a mobile suspension for heavy items.
- Use mechanical lifting devices whereby the height for manual materials movement can be adjusted, such as lift-trucks or adjustable conveyers.
- Eliminate differences in height of working surfaces.

POINTS TO REMEMBER

Move materials at working height. Use mechanical devices to raise or lower material to this working height.

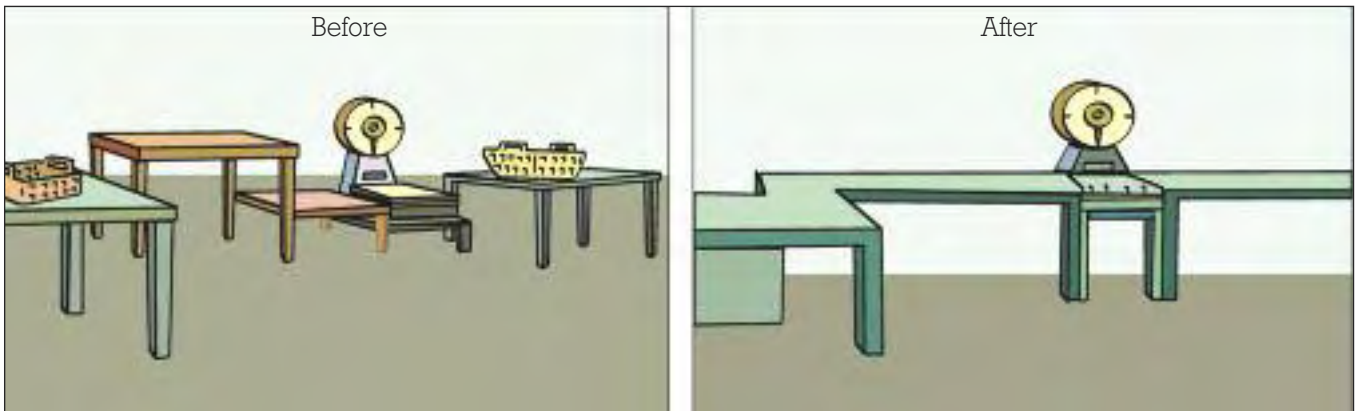

Figure 13a. Eliminate height differences of work surfaces.



Figure 13b. (i) and (ii) Minimize lifting and lowering movements.



Figure 13c. Push and pull heavy materials instead of raising and lowering them.



Figure 13d. Move materials along surfaces of the same height.

CHECKPOINT 14

Eliminate tasks that require bending or twisting while handling materials.

WHY

Bending or twisting of the body is an unstable movement. The worker spends more time and becomes more fatigued than when doing a similar amount of work without bending or twisting.

Bending and twisting of the body is one of the major sources of back injuries, and neck and shoulder disorders.

RISKS / SYMPTOMS

- muscular strain
- low back pain
- slips, trips or stumbles
- excessive reach

HOW

1. Change the positions of materials or semi-products so that the handling work is done in front of the worker, without bending the body.
2. Improve the working space for doing handling work so that the worker can adopt stable foot positions without bending or twisting.
3. Use mechanical means to bring the work items to the front of the worker. The worker should be able to remove the work item and replace the finished item without being forced into an awkward posture.
4. Change the working height (e.g. by changing the height of the work table or feeding point) so that the worker can handle the work item without bending the body.

SOME MORE HINTS

- Avoid manual handling and carrying of heavy objects whenever possible. Bending or twisting while dealing with heavy objects is particularly harmful.

- Sometimes standing workers bend their body because they cannot get close enough to the work item owing to a lack of knee or foot clearance. Make sure that workers have enough clearance for their knees and feet.
- Avoid a combination of carrying while performing other tasks at the same time, as this is often the reason why the worker bends or twists the body. Rearrange the work so that the carrying task is the only task performed at that time.

POINTS TO REMEMBER

Back injury resulting from bending or twisting while handling a heavy load can cost you a great deal, as you may lose a productive skilled worker for quite a long period.

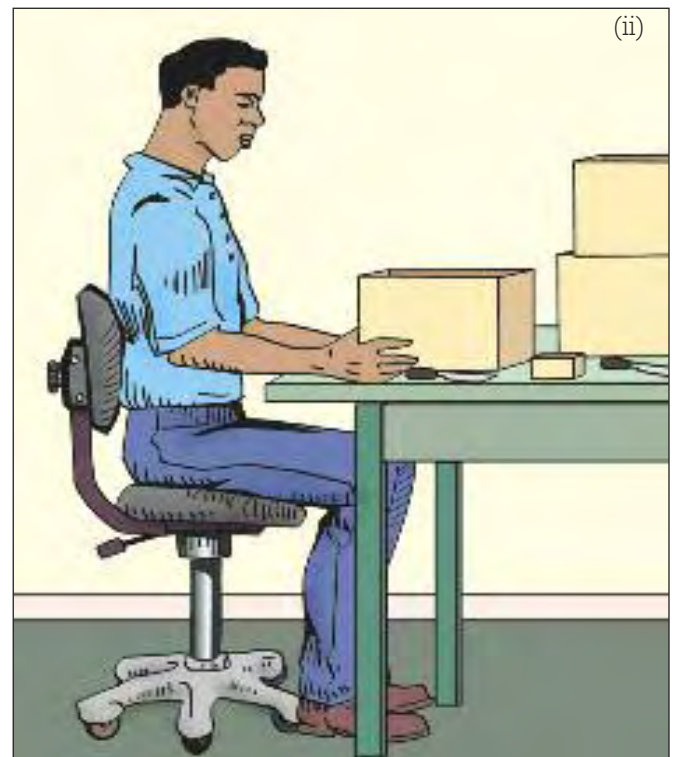

Figure 14a. (i) and (ii) Minimize the distance between the worker and the work item.

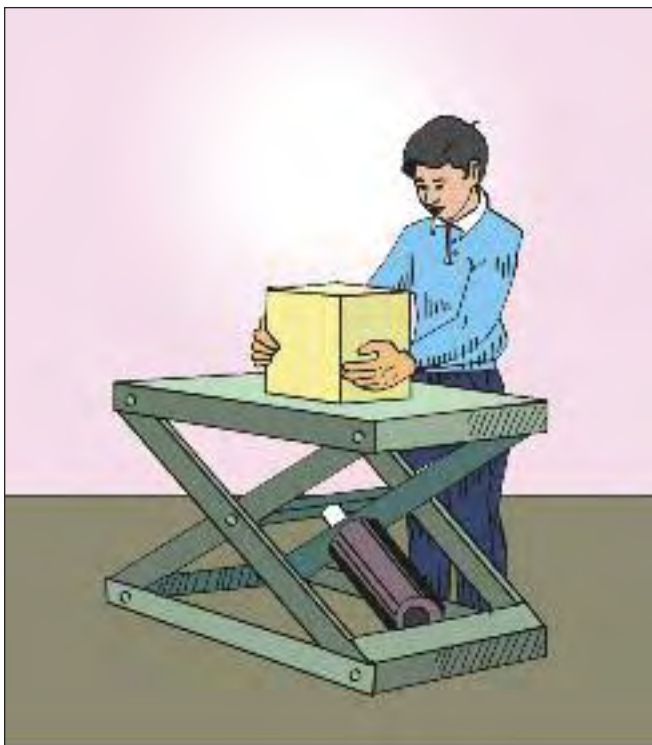

Figure 14b. Adjustable-height "scissor lift".

CHECKPOINT 15

Keep objects close to the body when manually handling materials.

WHY

Carrying an object close to the body minimizes forward bending movements, thus reducing the risk of back injury, and neck and shoulder disorders.

By holding objects close to the body, carrying is easier and can provide a good forward view. This increases efficiency and reduces accidents.

Bending or twisting of the body is an unstable movement. The worker spends more time and becomes more fatigued than when doing a similar amount of work without bending or twisting.

Bending and twisting of the body is one of the major sources of back injuries, and neck and shoulder disorders.

RISKS / SYMPTOMS

- muscular strain
- low back pain
- product damage
- slips, trips or stumbles

HOW

1. Provide handles, grips or good holding points for the load carried. Approach the load as closely as possible and hold it firmly and near the body. Use secure, stable foot positions.
2. If manual lifting of a heavy load is unavoidable, try to share the load by having two or more people carry it together.
3. When lifting or lowering of a heavy load is involved, do this slowly in front of the body. Use the muscle power of the legs (not the back) and keep the back straight.
4. While carrying, keep the load near the waist. It is often useful to provide adequate aprons, as they minimize the risk of injuries from uneven or sharp parts of the loads.
5. Organize carrying work so that it is done with minimal raising or lowering of the carried objects. For example, carry materials from a work surface to another work surface of the same height, or avoid putting materials on the floor by using stands or platforms of appropriate height.
6. When the load is heavy, consider the possibility of dividing it into smaller weights. If this is not possible, ask two or more people to carry the load, or use transport devices.
7. Change the working height (e.g. by changing the height of the work table or feeding point) so that the worker can handle the work item without bending the body.

SOME MORE HINTS

- While the weight of the load should not be large, using pallets, trays or containers to carry small items can reduce the number of trips. Wherever possible, it is preferable to use pushcarts and other mobile devices.
- Consider physical differences between different workers. Make sure that the weight and the frequency of loads are not excessive for the workers concerned.
- Sometimes standing workers bend their body because they cannot get close enough to the work item owing to a lack of knee or foot clearance. Make sure that workers have enough clearance for their knees and feet.
- The worker may prefer to carry a load on the shoulder, the head or the back depending on size and weight or local custom. Try to find alternative means of carrying, such as using an easy-to-carry container or a rucksack.
- Provide appropriate work clothes if there are frequent carrying tasks.

POINTS TO REMEMBER

When manual carrying of objects is unavoidable, lift and carry the object close to the body. This reduces fatigue and the risk of injury.



Figure 15a. Do manual lifting or lowering of a heavy load in front of the body, with the back kept straight and with stable feet positions, and use the power of the legs.



Figure 15b. A long heavy object can be lifted using the power of the legs by keeping the object as close to the body as possible.



Figure 15c. Handling grips adapted to the particular object carried can help.



Figure 15d. Lifting of heavy loads from a platform in front of the body while using the power of the legs. Lifting from a platform is better than lifting from the floor.

CHECKPOINT 16

Combine heavy lifting with physically lighter tasks to avoid injury and fatigue and to increase efficiency.

WHY

Manual lifting of heavy loads is tiring and a major cause of back injuries. If this cannot be replaced by the use of a wheeled device or mechanical transport, it is better to combine the heavy lifting with lighter tasks. The idea is to avoid concentrating unfavourably heavy tasks on a few workers.

Combining heavy lifting with lighter tasks reduces fatigue, as well as the risk of back injuries. This helps increase a worker's overall productivity.

If workers are trained to perform multiple tasks, it is much easier to find a substitute worker in the case of absence of one worker due to illness or leave.

RISKS / SYMPTOMS

- muscular strain
- low back pain
- repetitive strain

HOW

1. Reorganize job assignments so that workers who perform heavy lifting tasks perform lighter tasks as well.
2. Introduce job rotation and group work in order to prevent biased concentration of strenuous tasks on selected workers. This is easily done by forming a multi-member team.
3. For similarly strenuous tasks, consider job assignments so that these strenuous tasks can be shared by a group of people on a rotating basis.

SOME MORE HINTS

- Physically demanding tasks such as heavy lifting always require frequent breaks. Allow sufficient breaks for recovery from fatigue and for better productivity. Requiring frequent breaks as part of the work schedule may give you an impetus to combine the heavy tasks with lighter tasks.

- Alternating tasks is often far less tiring, and thus improves the worker's motivation and productivity.

POINTS TO REMEMBER

Avoid repeated heavy lifting all the time. Combine heavy lifting with lighter tasks in order to reduce fatigue and increase efficiency.



Figure 16. (i) Combine physically heavy work with lighter work. (ii) This reduces fatigue and increases efficiency.

CHECKPOINT 17

Provide conveniently placed waste containers.

WHY

Waste, scrap and spills of liquid on the floor not only represent a loss of material and a hindrance to the smooth flow of production, but are also an important cause of accidents.

Good housekeeping is difficult without providing waste containers in convenient places.

Conveniently placed, easy-to-empty waste containers help to create free space and reduce cleaning costs.

RISKS / SYMPTOMS

- muscular strain
- low back pain
- material spillage
- slips, trips or stumbles
- hand/arm injury
- leg/foot injury

HOW

1. Purchase or construct waste containers suitable for each type of waste: open box-style or cylinder containers or bins for scrap and rubbish (large enough for the type of waste); closed containers for liquids; and appropriate racks or platforms for longer or larger waste (such as wood splints, metal rods, etc.).
2. Put wheels under the waste containers so that the waste can be pushed to the place of disposal frequently and easily.
3. If oil or other liquid is spilt from machinery or from transport systems, construct removable trays underneath the object.
4. Consult workers about the best way to empty waste containers at appropriate intervals. Assign the responsibility of emptying waste to one person or rotate the emptying task among a group of workers. The idea is to include waste disposal as one standard activity of the work process.

SOME MORE HINTS

- Simple metal or plastic containers placed at each work area can often help maintain good housekeeping.
- A vacuum cleaner is a good, temporary waste container for small, dry particles. Wet waste requires a special vacuum cleaner (consult your dealer).
- Heavy waste can be handled more efficiently if the container can be opened at the appropriate height, e.g. from the side of the container at waist height.
- Reject materials stored in containers remain relatively clean, suffer less deterioration, and can be easily located when needed.

POINTS TO REMEMBER

Well-organized waste storage is necessary for good housekeeping. Waste thus stored can be recycled.



Figure 17. Provide conveniently placed, easy-to-empty waste containers.

Hand tools



CHECKPOINT 18

Select tools designed for the specific task requirements.

WHY

Special tools adapted to the particular operation greatly improve productivity. Such tools make the operation easier and therefore much safer.

Special tools can usually be purchased or made at low cost. Because productivity increases as a result, the benefits are far greater than the cost incurred.

In operating some special hand tools, small muscles in the fingers and hand are frequently used. If excess force is needed, these muscles get tired very easily. Because delicate movements are essential in some special tool operations, even slight muscle fatigue reduces output.

Repetitive tool operations requiring excess force or fixed postures can cause neck, arm and wrist disorders.

RISKS / SYMPTOMS

- muscular strain
- upper limb disorder
- hand/finger injury
- lacerations
- hand/arm vibration

HOW

1. Use special-purpose tools to do exactly the right job with the best quality and the least effort. Use precisely the right type, size, weight and strength of screwdrivers, knives, hammers, saws, pliers and other hand tools.
2. If the task requires frequent strenuous effort, use motor-powered tools. Various types are available. These motor-powered tools are not only more efficient but can perform tasks that are impossible for manual operation. Workers' fatigue is far less.
3. Arrange for "homes" for tools not in use, and for their regular maintenance.
4. Avoid tools that require excess finger force. The muscles for moving fingers are particularly affected

by excess force. For example, use trigger strips rather than trigger buttons, as fingers combined are stronger than individual fingers.

5. Instruct workers about the correct use of the tools. Have them ask for repair or replacement when the tools are damaged or worn out.

SOME MORE HINTS

- Tool cost has three components: purchase (or production), maintenance, and use of utilities. Most non-powered hand tools cost less than the hourly labour cost. Even powered hand tools usually cost less than 20–50 times the hourly labour cost. Yet tools are used for a number of years. For example, a powered screwdriver may cost 50 times the hourly labour cost, but can be used for 1,000 hours a year for 5 years.
- Non-powered tools tend to need 0–5 hours of maintenance per year; powered tools need 10–100 hours per year. Thus even at 50 hours' maintenance in a year, the hourly cost is only a small fraction (say 1/30th) of the hourly labour cost.
- Even a relatively expensive tool (e.g. a powered screwdriver), including maintenance and utility expenses, costs only about 3% of the labour cost per hour. Compare this with the increase in productivity. Also consider better-quality output and reduced stress for workers.
- Use springs (not muscles) to open scissors, pliers, clippers, etc.
- When push or pull movement is needed, push or pull below the shoulder and above the hip; within this range the muscles are strongest. When cutting with a knife, keep the cutting edge down; cutting away has twice the strength of across-body motions.

POINTS TO REMEMBER

Special-purpose tools are an extremely worthwhile investment. They are cheap, and greatly improve productivity and safety.

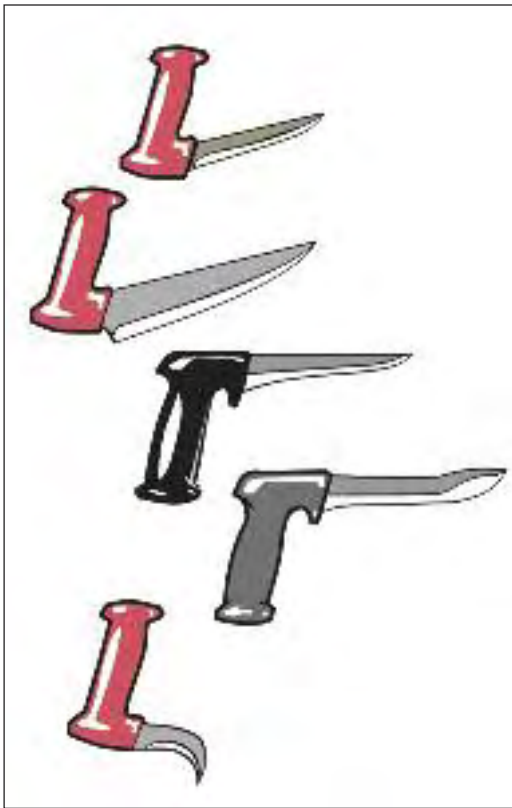

Figure 18a. Tools made for different specific purposes can work better than general-purpose tools

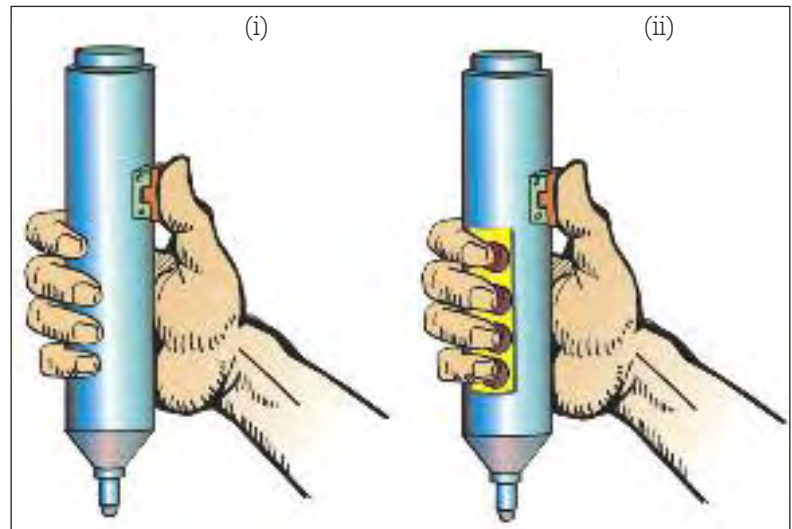

Figure 18b. Thumb-operated and finger-strip-operated pneumatic tools. (i) Thumb operation results in over-exertion. (ii) Finger-strip control allows all the fingers to share the load and the thumb to guide the tool.



Figure 18c. (i) and (ii) Steady grips of power tools help reduce the required force of operation.

CHECKPOINT 19

Provide safe power tools and make sure that safety guards are used.

WHY

Power tools are efficient but usually more dangerous than non-power tools; the greater the energy, the greater the danger. Nevertheless, safe power tools are available. There is no need to use unsafe tools.

Safe tools are more productive as they tend to operate faster and more accurately than non-powered tools.

RISKS / SYMPTOMS

- amputation
- hand/finger injury
- excessive force
- upper limb disorder

HOW

1. Order power tools only after safety specifications have been examined. Three important points are: protection against power transmission and points of operation; prevention of unintended activation of controls; and easy operation with secured grips.
2. Purchase tools that have been designed for use with a balance if they are to be used over a fixed workstation.
3. Compare the guards provided for the power tools you are going to purchase with those of other kinds or of similar tools. Not only dealers but also your fellow workers can help.
4. Check that the guards are sufficient to protect workers, and are used.
5. Guards should not interfere with work, otherwise people will remove them.
6. Check if multiple means are used in order to prevent unintended activation of controls. For example: controls are not protruding towards the outside of the equipment; there should be sufficient space between controls; controls are recessed or

covered with a barrier; controls require more than minimal force to activate them; an interlock, a key or an enabling control is used for power switches.

SOME MORE HINTS

- Organizations, not workers, should buy and maintain work tools. Workers usually do not have the technical knowledge to know which is the best tool, and may also not be able to pay for such a tool.
- Consider the whole line of action from fetching the tool, setting it in motion, going from one operation to another, and putting it away. Make sure that the worker is safe throughout.
- There are two classes of guard: (a) equipment guards, and (b) people guards (also called personal protective equipment). Do not forget people guards. Make such guards (gloves, aprons, shields, etc.) available.

POINTS TO REMEMBER

A safe person is a productive person. A safe tool is a productive tool.

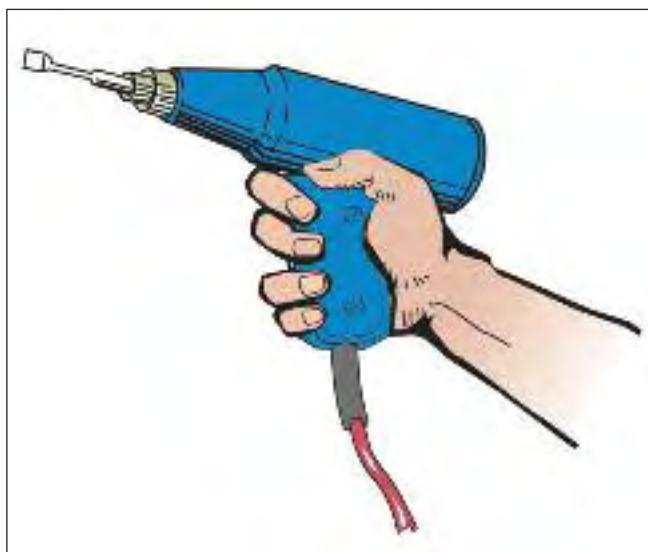
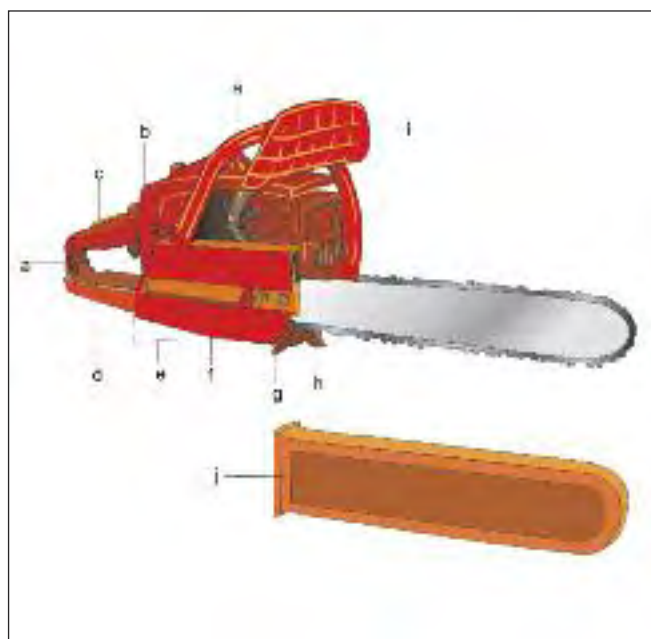

Figure 19a. An example of a tool with a trigger that is long enough, allowing a firm grip by the hand.

Figure 19b. Working with power tools can be dangerous. For this reason modern chainsaws, for example, have several safety devices. Without the following safety devices, chainsaws should not be used:

- a. separate handles for both hands when wearing gloves
- b. an on/off switch (reachable with the right hand on the throttle)
- c. a throttle control lock-out (prevents the chainsaw from being started unexpectedly)
- d. a rear handle guard (for protection of the right hand)
- e. an anti-vibration system, consisting of rubber shock absorbers between the engine block and handles (prevents vibration diseases of the hands)
- f. a chain brake (activated manually by the front handle guard or by means of a non-manual mechanism in the case of kick-back)
- g. a chain catcher (catches the saw chain if it breaks)
- h. a spiked bumper (allows the weight of the saw to rest securely)
- i. a front handle guard (for protection of the left hand from the chain)
- j. a chain guard (for avoiding injuries during transport of the chainsaw)

Personal protective equipment is also required (see checkpoints 100–105).



CHECKPOINT 20

Use hanging tools for operations repeated in the same place.

WHY

Hanging tools can be grasped easily near the point of operation. You can save the time needed to put the tool down and pick it up again. The time grasping the tool is shorter and the worker's fatigue is less.

Hanging tools are always easy to find. You need not create a "home" for them, such as a tool-rack or a side table. You can save space in this way.

When operations are repeated in the same place, hanging tools help organize the workplace, thus increasing the worker's efficiency.

RISKS / SYMPTOMS

- muscular strain
- excessive reach
- repetitive strain
- upper limb disorder
- hand/finger injury

HOW

1. Check which tools are used repeatedly for the same operation by the same worker. Choose one or more of these tools for use as hanging tools.
2. Provide a horizontal frame over the worker from which these tools can be hung. Use a spring mechanism so that the hanging tools can go back to their original place automatically.
3. If necessary, provide a special frame for each hanging tool so that the tool is placed at the front of the worker and can easily be brought nearer to the worker while in use.
4. Make sure that hanging tools are within easy reach of the worker.
5. Also ensure that, when not in use, hanging tools do not interfere with the worker's arms and movements.

SOME MORE HINTS

- Hanging tools should be of appropriate size and weight. Hanging tools of considerable weight can be used only when a special, stable hanging mechanism is constructed for their easy and safe operation.
- If hanging tools are to be used by workers, make them adjustable to varying levels of hand reach.
- In the case of wear or breakage, hanging tools should be easy to replace and maintain.

POINTS TO REMEMBER

Hanging tools provide a good solution for storage and easy operation, while increasing the worker's efficiency and productivity.

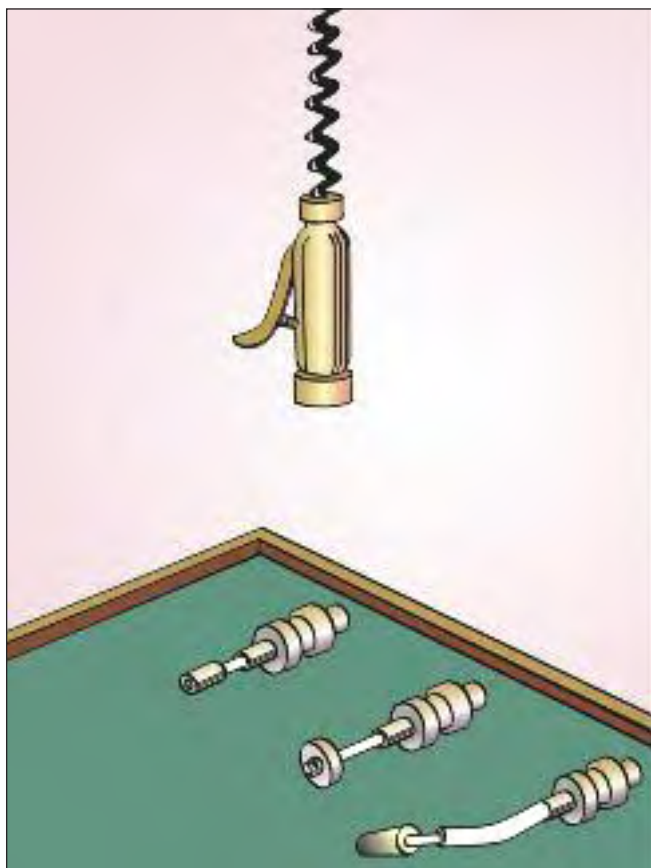

Figure 20a. A handy and safe power tool that has operating parts exchangeable for each specific purpose can save time and effort.



Figure 20b. Hanging tools within easy reach of workers are suited to repeated operations.



Figure 20c. Provide a special overhead frame from which tools can be hung by means of spring mechanisms.



Figure 20d. Placement of tools in accordance with frequency of use.

CHECKPOINT 21

Use vices and clamps to hold materials or work items.

WHY

Manual operations greatly improve when the materials or work items are firmly fixed. Vices and clamps allow workers to use different sizes and shapes of workpieces steadily during the work.

The use of vices and clamps allows the workers to use both hands.

Vices and clamps also reduce accidents, as they prevent slippage of material, reduce the need for maintaining a bad posture and provide better control over the work item.

RISKS / SYMPTOMS

- hand/finger injury
- muscular strain
- excessive force
- upper limb disorder

HOW

1. Select the appropriate vices or clamps, considering the sizes and shapes of workpieces.
2. If possible, make the location of the vice or clamp fixture adjustable on the work surface.
3. If the task requires the worker to access the workpiece from different directions, select clamps that can rotate.
4. Locate vices and clamps to allow workers to perform work in a natural posture or position. The working height should be a little below elbow level.

SOME MORE HINTS

- Select a vice or a clamp that minimizes the force required to secure the workpiece in it.
- Make sure that the vice or clamp has no sharp edges.

- Select a vice or clamp that allows the worker to know when the workpiece is secured in place, without damaging the workpiece.

POINTS TO REMEMBER

A work item secured in a vice or clamp is a safe work item.

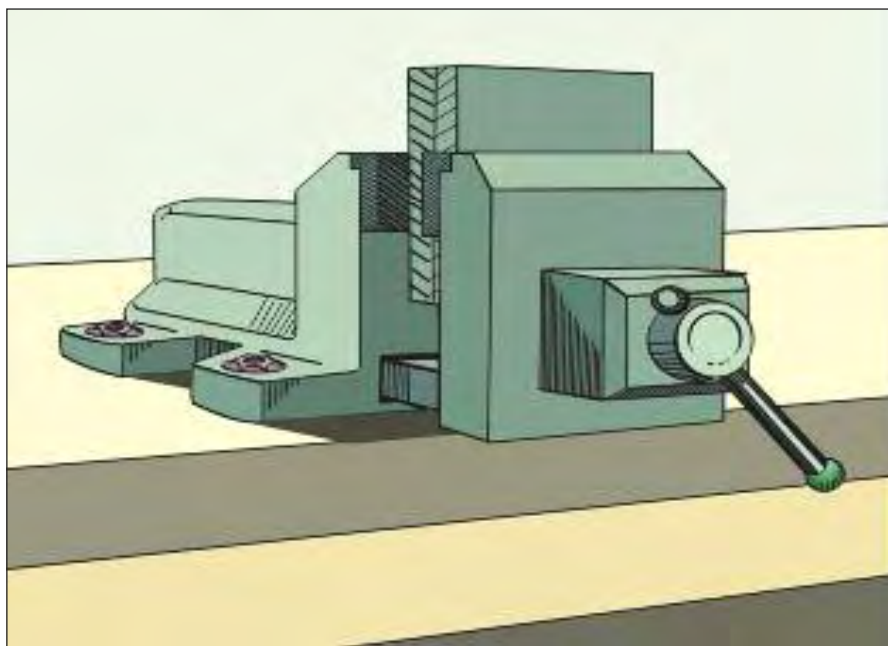

Figure 21a. Use a vice or a clamp that can hold the work item steadily at the appropriate height.

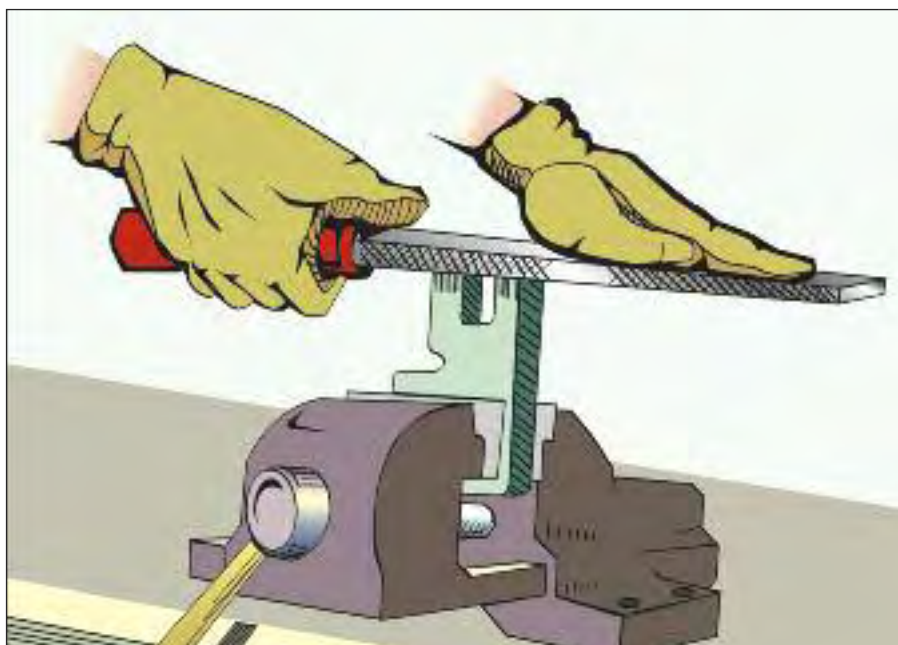

Figure 21b. The use of vices or clamps allows the worker to use both hands for productive work.

CHECKPOINT 22

Provide hand support when using precision tools.

WHY

Accuracy of tool operation or precision work depends much on the stability of the hand doing the work. The precision grip is different from a power grip and requires about one-fifth of the strength of the power grip. The accuracy of the precision work is affected by slight movements of the hand.

Hand support reduces tremor (slight trembling) and increases accuracy.

RISKS / SYMPTOMS

- upper limb disorder
- muscular strain
- hand/finger injury
- hand tremor

HOW

1. Provide a support near the point of operation so that the hand (0.6 per cent of body weight) or the hand and the forearm (2.8 per cent of body weight) can be supported during work.
2. Try out various positions and shapes of the hand support to get the best results. If appropriate, provide an adjustable support.
3. If appropriate, place the precision tool on a support as much as possible. Artists have been using steady rests for centuries.

SOME MORE HINTS

- Minimize forceful exertions with the hand, as the arm muscles that control the hand are very sensitive to tremor. For example, surgeons should not carry a suitcase for 24 hours before performing an operation.
- Shield the front of some tools (e.g. a soldering iron). The shield reduces the impact of flying objects from the work, and acts as a support for the hand.

The shield will prevent the forward slip of the hand, and the operator can grip the tool closer to the work, giving better control of the tool tip.

POINTS TO REMEMBER

To increase accuracy, support the precision tool or the hand doing the work, or both.



Figure 22a. A hand or forearm support near the point of operation increases the efficiency of precision work.



Figure 22b. Try out various positions and shapes of hand support to get the best results.

CHECKPOINT 23

Minimize the weight of tools (except for striking tools).

WHY

Tool weight often fatigues the user, thus reducing productivity.

Except for striking tools (hammers, axes), tools of the minimum weight are easier to handle and allow precise operations.

Lighter tools are easier to store and simpler to maintain.

RISKS / SYMPTOMS

- muscular strain
- excessive force
- low back pain
- upper limb disorder

HOW

1. Choose tools suited to the purpose but of minimum weight.
2. There are various ways to minimize the actual weight that has to be held by the hand. For example, support the tool on a steady rest; this also improves accuracy.
3. If appropriate, slide the tool along a surface (the surface supports the tool).
4. Suspend the tool on a balancer above the tool's centre of gravity. Typically the balancer pulls upward with slightly more than the weight of the tool (e.g. 2.1 kg on a 2 kg tool). When the tool is released, it goes up and out of the way (but still within reach).

SOME MORE HINTS

- Work with the tool close to rather than away from the body. In this way the actual force required to handle the tool is less. For example, a 2 kg tool held by the hand at the end of an arm that is 70 cm long exerts a 140 kg/cm rotation force (torque) about the

shoulder, while the same tool held at only 35 cm away from the shoulder exerts a 70 kg/cm rotation force. The worker feels as if he or she is holding a much lighter tool.

- Use tools with the tool handle below the tool balance point (centre of gravity). If there is little effective tool weight, and if the tool balance point is difficult to find, then you can locate the appropriate tool handle position (that minimizes tool action force) by making some trials.

POINTS TO REMEMBER

Lightweight tools reduce fatigue, allow better accuracy and increase productivity.

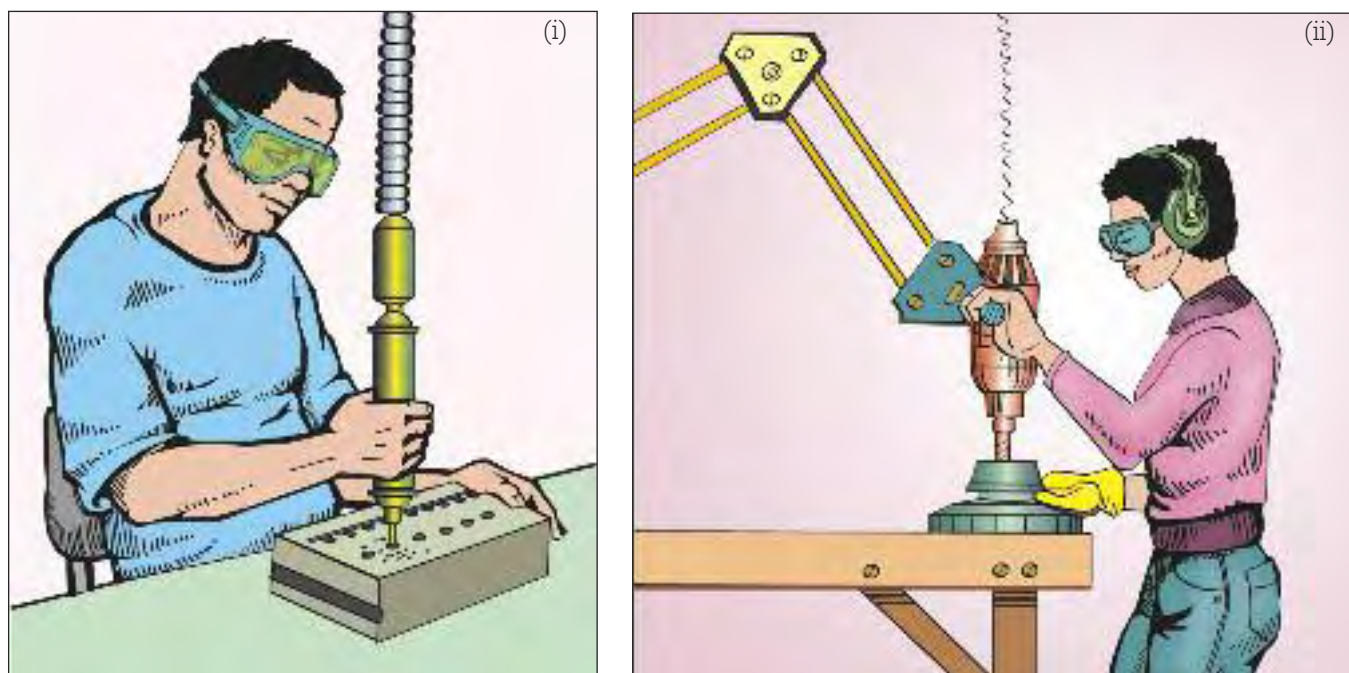

Figure 23a. (i) and (ii) Suspending the tool above its centre of gravity can make the tool work more easily and effectively.

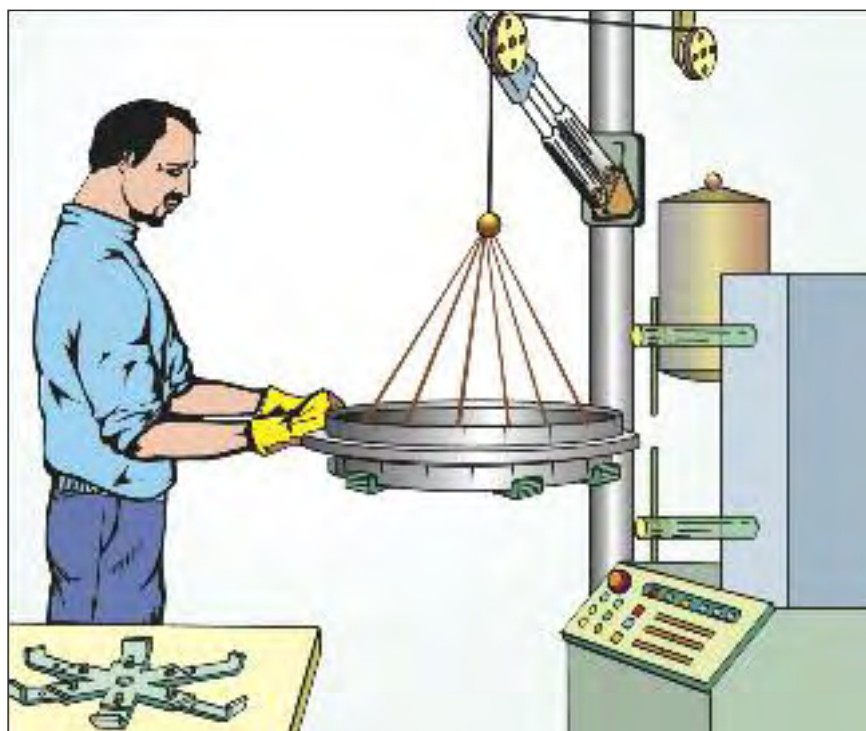

Figure 23b. Balancing mechanisms can also be used to minimize the weight of tools and work items together.

CHECKPOINT 24

For hand tools, provide the tool with a grip of the proper thickness, length, shape and size for easy handling.

WHY

Every hand tool has two ends: one works on the material and the other on the hand. The grip end must be adapted to the hand and to the operation. Its shape as well as its thickness and length are important.

A good grip allows the worker to use the tool with firmer control and less force. This improves the quality of the work being produced, and reduces fatigue and accidents.

RISKS / SYMPTOMS

- muscular strain
- upper limb disorder
- hand/finger injury

HOW

1. When a single handle of the tool is grasped by the whole hand (i.e. the four fingers reach around the handle and are "locked" by the thumb over the first finger), ensure that the handle diameter is 30–40 mm. For double-handled tools, the initial span (which exists before using the tool) should be less than 100 mm and the closed span 40–50 mm with a handle diameter thick enough to cause no pain.
2. In the case of a hook grip (briefcase-style, with the four fingers acting as a group but the thumb passive and relaxed), or in the case of an oblique grip (golf-club style, with the thumb pointing along the tool axis to improve precision), use a handle diameter of 30–55 mm.
3. Make sure that the handle length is at least 100 mm; 125 mm is more comfortable. Use a handle of at least 125 mm if the hand is "enclosed" (e.g. a saw) or if a glove is worn.
4. Check whether the tool size provided is suitable for the individual worker. Tools are often designed for male hands; for tools to be used by women, you may need to buy from vendors who furnish smaller sizes.

5. Check whether the wrist is able to stay in the neutral (handshake) position while the tool is used. For example, a pistol-style grip may be a good solution.
6. Purchase tools suitable for both right-handed and left-handed workers.

SOME MORE HINTS

- Make the grip usable by either hand. This is because using both hands alternately can help to reduce cumulative trauma, and because about 10 per cent of people are left-handed.
- Note that gloves increase the hand size. It is therefore necessary to try out the grip size and its hand clearance by using it with gloved hands.

POINTS TO REMEMBER

A tool should fit you like clothing. Use tools with a grip size suited to you.



Figure 24a. Alternative tools can be used to reduce mechanical stress, such as a screwdriver equipped with a ratchet.

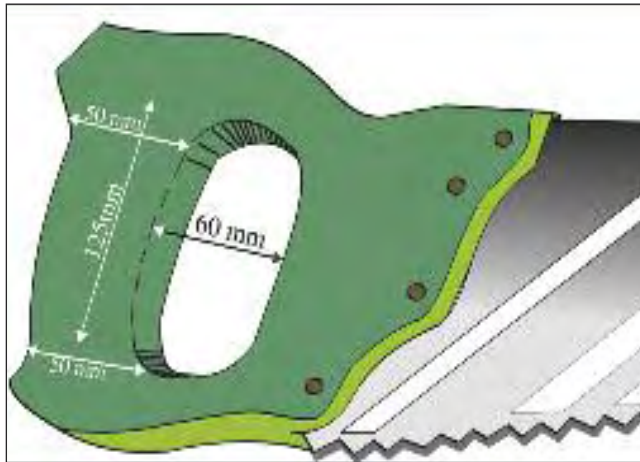

Figure 24b. The tool grip should be of the proper thickness, length and shape.

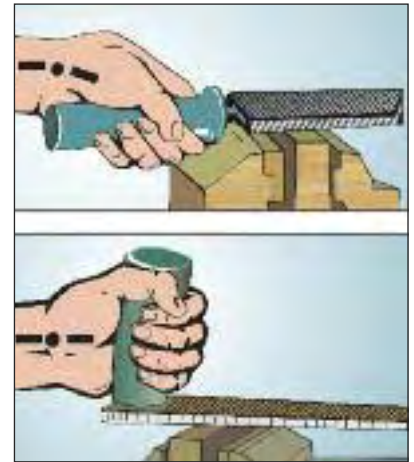

Figure 24c. For firm and safe tool operations allow the four fingers to reach around the grip, enabling the thumb to come over the first of them.

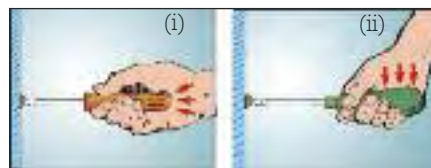

Figure 24d. The handle in (ii) reduces mechanical stress by distributing force over a larger area of the hand than in (i).

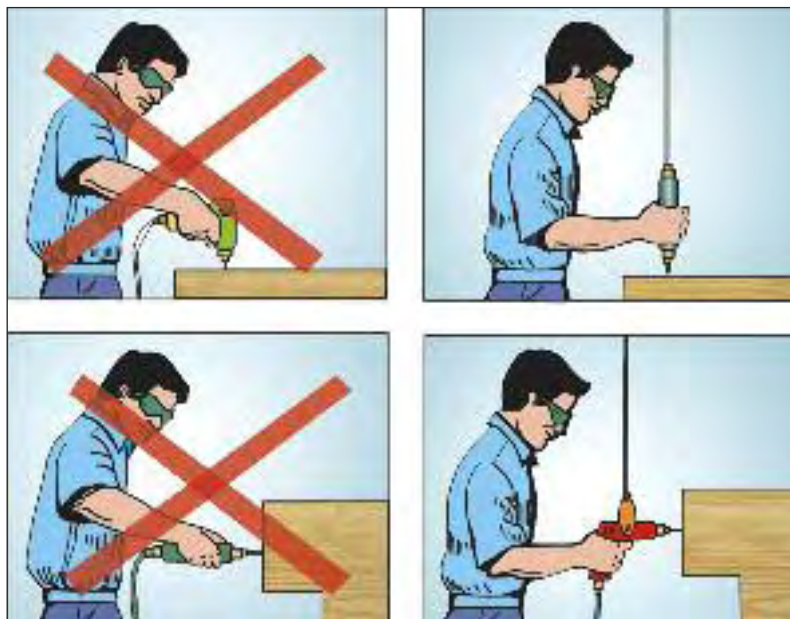

Figure 24e. A tool should be used (as above) on a horizontal surface at elbow height, or (as below) on a vertical surface above knuckle height. Suspension of the tool can help you get a better grip.

CHECKPOINT 25

Provide hand tools with grips that have adequate friction or with guards or stoppers to avoid slips and pinches.

WHY

Slips of the hand or pinches while using tools cause injury. Slips and pinches can be prevented by improving the tools.

Loss of control of the tool may cause damage and injury. Fear of slips and pinches reduces the quality of work.

RISKS / SYMPTOMS

- hand/finger injury
- hand/arm vibration
- upper limb disorder

HOW

1. Reduce tool rotation in the hand by using grips that have a non-circular cross-section, and by using grip surface material with a good coefficient of friction (e.g. vinyl, rubber, soft plastic).
2. Use a wedge-shaped tool (with a change in cross-section) to reduce the forward movement of the hand and to allow more force to be exerted.
3. Use guards or stoppers at the front (e.g. for knives and soldering irons) to act as a shield against slips, as well as to reduce hand movement and allow more force.
4. Use pommels (shields at the rear of the tool grip) to prevent loss of the tool and to make movement of the tool towards the body easier.
5. Choose tools with grip shapes that do not produce pinches.

SOME MORE HINTS

- Tool surfaces tend to become slippery after a period of work because of sweat, oil, etc., on the hand. Grips should be covered with good friction

material. Guards against slipping are particularly important when strong force is exerted when using the tool.

- If there is a guard to prevent slipping, you can hold the tool further forward and improve accuracy.
- Open two-handled tools (such as scissors or pliers) with a spring (that is, the tool is “normally open”) are often useful.
- Occasionally the tool should rotate in the hand; in this case a circular cross-section is useful.

POINTS TO REMEMBER

Guards on grips to prevent slips and pinches can reduce accidents, as well as improve work quality. Purchase or choose hand tools with such grips.

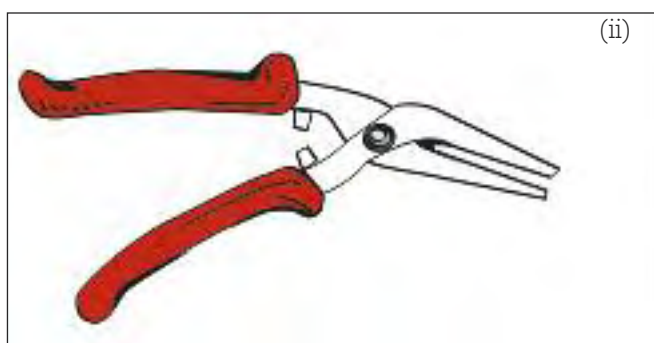

Figure 25. (i), (ii) and (iii) Grips that prevent forward movement of the hand allow safe and effective tool operations.

CHECKPOINT 26

Provide tools with proper insulation to avoid burns and electric shocks.

WHY

When using hand tools, workers tend to concentrate hard on the point of operation and forget the danger of burns and shocks. Burns and shocks while using tools are preventable.

Materials with low thermal conductivity have low electrical conductivity. Thus protection against burns (and freezing) also protects the worker from electric shocks.

RISKS / SYMPTOMS

- burns
- electric shock
- hand/finger injury

HOW

1. Use grip surface material with low thermal conductivity, such as rubber, wood or plastic. Metal has high thermal and electrical conductivity and can be dangerous.
2. For metal handles, even a thin layer of plastic (e.g. a sleeve) can greatly reduce thermal conductivity and increase grip comfort.
3. In the case of electrically powered hand tools, use grounded plugs and double-insulated tools (where the handle is insulated from the power).

SOME MORE HINTS

- When the danger of burns or electric shocks while using the tool is real, use gloves that suitably protect the hand.
- Using battery-powered tools is a good way of preventing electric shocks. Such tools also give mobility.

POINTS TO REMEMBER

Cover metal handles with plastic, rubber or wood to avoid electric shocks and to increase grip comfort. Purchase or choose tools with such handles.

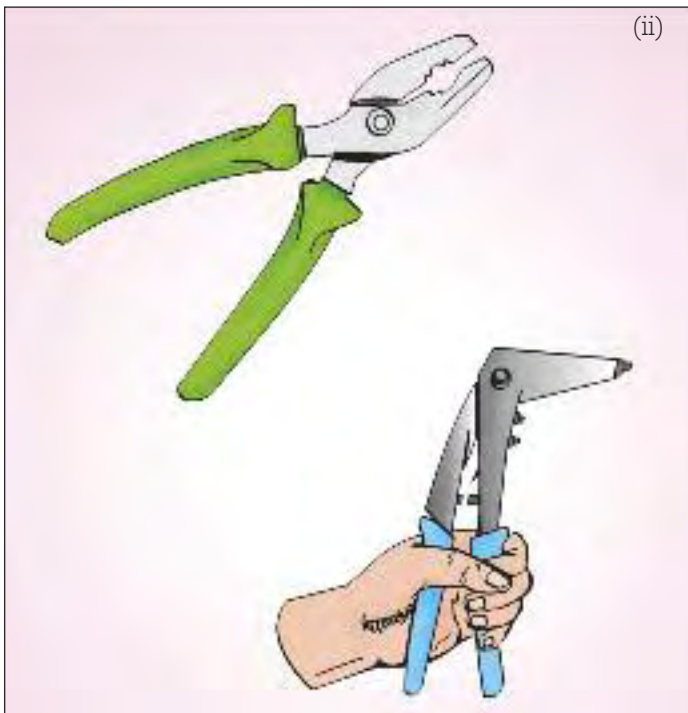
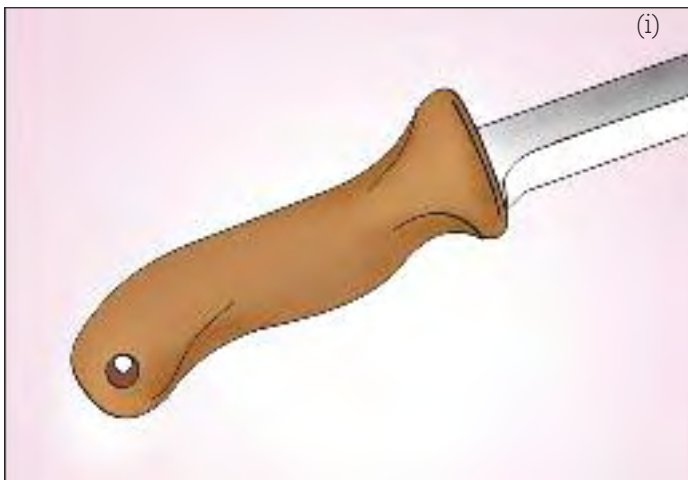

Figure 26. (i) and (ii) For metal handles, provide proper insulation that can prevent burns and electric shocks.

CHECKPOINT 27

Minimize vibration and noise of hand tools.

WHY

Vibration from the tool transmitted to the hands not only disturbs the tool operation but also injures nerves, tendons and blood vessels.

A hand-tool operator is always near the noise source. Noise damages hearing and hinders communication with other workers.

Exposure to hazardous vibration and noise is particularly significant for hand-tool operators because they are exposed for as long as they work.

RISKS / SYMPTOMS

- hand/arm vibration
- muscular strain
- hearing loss

HOW

1. Separate a noisy hand-tool operation from other parts of the workplace, for example by means of partitions or placing the noisy operation in another room, so that any noise affects only the tool operator. The inverse square law says that every doubling of distance reduces noise by 6 dB.
2. Depending on national regulations, noise exposure limits can vary from 85 to 90 dB(A) averaged over a working day. Take into account the need to reduce the noise level to the lowest possible.
3. Purchase hand tools with low vibration and a low noise level. This requires making vibration and noise specifications part of the purchase order and purchasing tools with good enclosure, vibration buffers and noise mufflers.
4. For pneumatic (air-powered) tools, use pressure regulators so that the tool operates at the design pressure instead of full line pressure.
5. Use automatic shut-off (i.e. turning off the noisy machine or tool when it is not in operation). This ensures the least possible exposure to vibration and noise, and saves energy.

6. Provide hearing protection for the workers if there is no other way to reduce the noise level to a safe level.
7. Consult a noise specialist about how to reduce noise and vibration (noise specialists are also knowledgeable about vibration).

SOME MORE HINTS

- Electric hand tools are often quieter than pneumatic hand tools.
- Maintenance greatly helps to keep vibration and noise levels to a minimum. Tighten screws and bolts. Sharpen tools. Lubricate bearings. Grease and oil parts. Rebalance rotating equipment. Replace leaky compressed air valves.
- Orient workstations so that noise from the neighbouring workstation hits the ears of the others from the rear (best) or front rather than the side. This may reduce the noise effect by 5 dB.
- Provide good personal protective equipment against vibration and noise. This may include ear protection for the noise as well as specially designed anti-vibration gloves.
- Cross-reference the exposure to noise and vibration with other hazards such as dusts, fumes and cold air from the tool.

POINTS TO REMEMBER

Make noise and vibration specifications part of the purchase order for power tools. Also ensure automatic shut-off to minimize exposure.



Figure 27. Provide good protection against noise and vibration, such as ear protectors, which protect against the effects of noise, and hand guards, which can diminish the impact of vibration.

CHECKPOINT 28

Provide a “home” for each tool.

WHY

If each tool has a “home”, i.e. a special and permanent place allocated to it, workers can find the tool quickly and are encouraged to use the right tool at all times.

If tools do not have “homes”, some workers lose time searching for lost tools. Providing a “home” for each tool is an effective way to prevent this time loss.

Tools stored in their special places can be seen at a glance. Their inventory is therefore easy. This is a great help for good maintenance.

RISKS / SYMPTOMS

- tool damage
- slips, trips or stumbles
- hand/arm injury

HOW

1. There are various means of providing a “home” for each tool. This can be a special shelf, a drawer, a particular place on a rack, an easy-to-see container, a tool trolley, a hook on the wall, suspension from an overhead structure, or a tool board. The most appropriate means should be chosen considering the size, shape and weight of the tool.
2. Do not forget to find a “home” also for bigger tools. Avoid the practice of putting large tools on the floor.
3. When various small tools are used, provide a tool storage board or special containers in which each tool has its own “home”. A specially designed tool board for this purpose is useful.
4. In the case of a tool board, the outline of each tool could be drawn to show where it goes. Alternatively, labels could indicate where each tool goes.
5. The more frequently a tool is used, the closer its “home” should be to the worksite where it is used.

SOME MORE HINTS

- A series of small tools or tool parts of similar kind (such as tapes, drills, cutters, etc.) can be stored in special bins, trays or inserts with labels or a clear indication for each item. The necessary parts can then be taken out at a glance and put back easily.
- When the worker, or a group of workers, frequently changes worksite, use portable toolboxes, tool trolleys or mobile tool storage racks.
- Suspended tools do not crowd the workbench and can be easily grasped. They always return automatically to their suspended “home”.

POINTS TO REMEMBER

Without clearly designated “homes” for tools, it is difficult to put different tools in order. By providing a “home” for each tool, we can avoid time lost searching for tools. This is a good starting point for their proper use and maintenance.

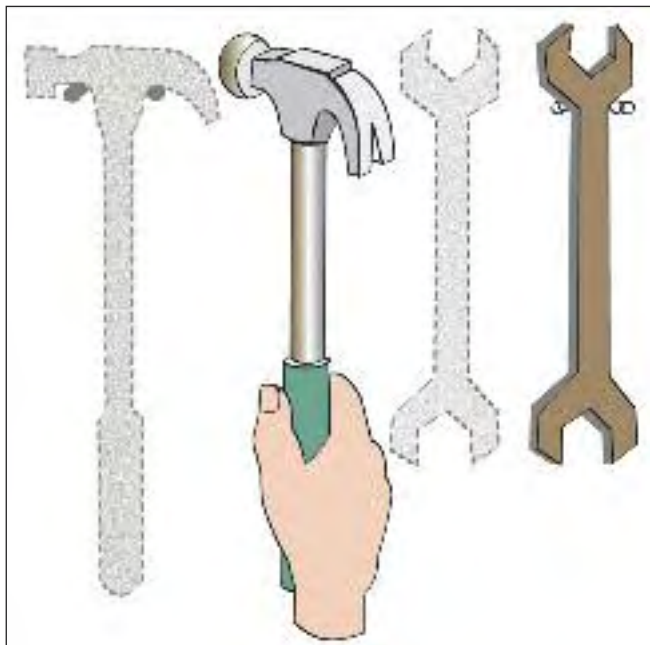

Figure 28a. The outline of each tool should be drawn on the tool board to show where it goes. This helps maintain order and immediately shows if anything is missing.

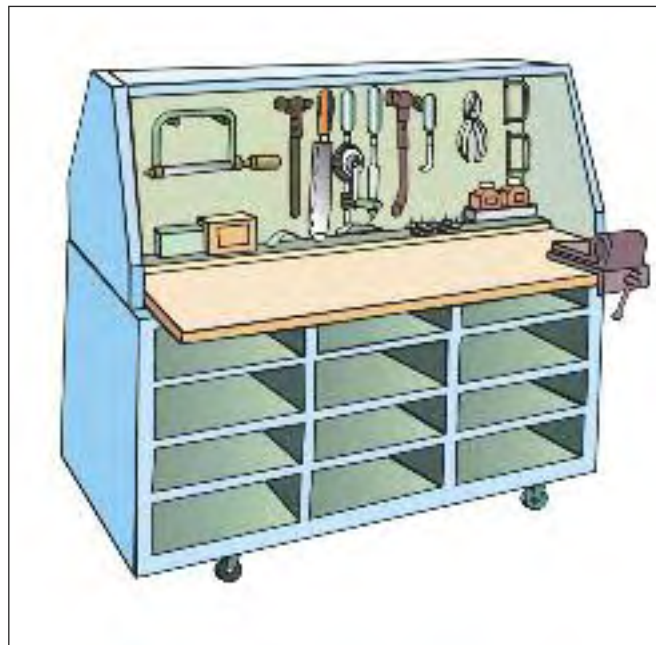

Figure 28b. A mobile workstation for a metalworker.



Figure 28c. Provide “homes” close to the worker for tools used repeatedly. “Homes” for tools used less frequently can be placed around the workstation.

CHECKPOINT 29

Inspect and maintain hand tools regularly.

WHY

Tools that do not work properly increase the operator's downtime and thus lower productivity.

Poorly maintained tools can cause accidents. The result may be serious injuries.

Regular maintenance of tools should be part of good management. Cooperation of all workers in this respect has positive effects on production and human relations.

RISKS / SYMPTOMS

- serious injury or accident
- muscular strain
- hand/arm vibration

HOW

1. Begin by purchasing reliable hand tools. Insist on always using reliable hand tools. Instruct all workers to replace a failed hand tool quickly.
2. Establish routines for regular inspection of hand tools. Some tools can be inspected by workers themselves, while others should be inspected by qualified personnel.
3. Provide a spare hand tool, or spare parts, on site.
4. If possible, provide substitute modules that can be used for replacing broken tool parts. Such substitute modules are easy to handle and permit quick repair by unskilled workers. All that is needed in the case of tool trouble is to take out the broken module and install a fresh one. Repair can be done later by the supplier or by skilled workers.

SOME MORE HINTS

- Maintenance time (the time taken to inspect and fix a tool) is usually small compared with the time taken to find that the tool does not work, to find the problem and (especially) to obtain the repair parts.

- Increased downtime (time taken to locate the fault, obtain parts and carry out repairs) means decreased work time for the tool. Reduce this downtime by arranging replacement of parts/modules in advance.

POINTS TO REMEMBER

Poorly maintained tools require extra effort and reduce accuracy. Therefore consider "preventive maintenance", i.e. fixing things before they break. This is very important for maintaining tools.



Figure 29a. Servicing tools is very important, and repairs should be carried out by properly skilled tradespersons.



Figure 29b. Provide adequate places for regular maintenance and repair of tools.

CHECKPOINT 30

Train workers before allowing them to use power tools.

WHY

Power tools can increase production because they are faster and stronger than people. However, these advantages can be lost if they are used incorrectly.

Power tools are stronger than non-powered tools, and therefore injuries and damage caused by their incorrect use will be more serious.

Power tools are always used for specialized tasks that require skills. Train and retrain workers for better skills and safety.

RISKS / SYMPTOMS

- serious injury or incident
- muscular strain
- hand/arm vibration

HOW

1. When purchasing power tools, make sure that they come with good instructions about their proper use.
2. Identify errors, scrap loss, injuries and slow cycle times caused by improper use of power tools. Interviewing workers gives you useful information, too.
3. Arrange for time to train and retrain those who use power tools in the correct operation of the tools.
4. Safety should always be an important part of such training.
5. Identify workers who are skilled at operating power tools and get them to train others in how to achieve the same high productivity and safety.

SOME MORE HINTS

- Consult instructions or manuals that come with the power tools for more hints on proper operation.

- Ask those who use power tools which tools are most difficult to operate. These problems may disappear with training.
- Training in tool use is an important part of new employee training. It is easier to train workers before they develop habits than to get them to break bad habits.

POINTS TO REMEMBER

To make sure workers are using their tools correctly and safely, they must be properly trained in advance.



Figure 30a. New employees must be given detailed information by supervisors and co-workers. Information must also be provided when introducing new machines so that work may be carried out as safely as possible.



Figure 30b. Get skilled workers to train others in how to achieve the same productivity and safety.

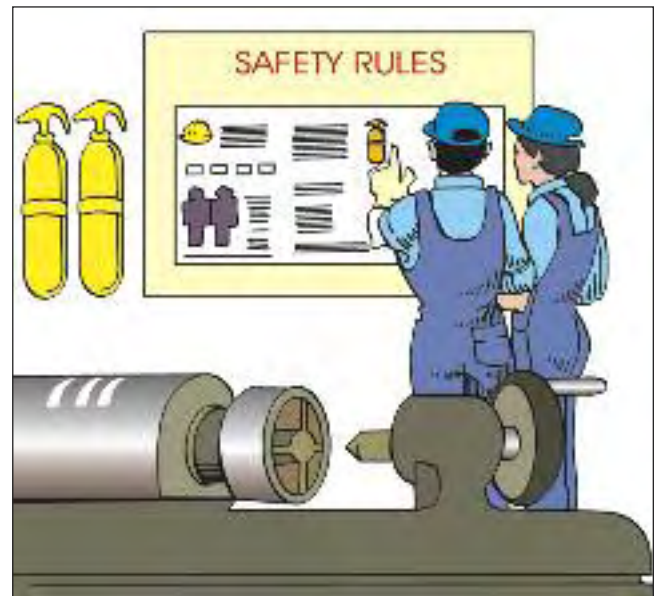

Figure 30c. Workshops should have their own safety rules displayed on the workshop wall. Learn these rules.

CHECKPOINT 31

Provide enough space for stable postures and stable footing during power tool operation.

WHY

A stable posture should be used while operating a power tool. Proper footing is always necessary. Productivity and efficiency of power tool operation are thus significantly increased.

Loss of control during power tool operation is very dangerous. Improper footing is fatiguing. There must be enough space for the operation and for good footing.

RISKS / SYMPTOMS

- muscular strain
- upper limb disorder
- leg/foot injury

HOW

1. Make sure that the floor for the power tool operation is flat, even and non-slippery. Provide an appropriate platform if necessary.
2. Remove potential obstacles to the tool operation.
3. Provide sufficient knee clearance, as well as foot clearance, so as to allow a stable posture close to the point of operation.
4. Provide emergency or automatic shut-off in case the worker slips.

SOME MORE HINTS

- Adjust the working height for each worker so that the power tool is operated somewhat below the elbow level and in front of the body while proper footing is ensured.
- Check whether the worker's footwear is suitable for the operation and for safety.
- If appropriate, consider the provision of a balancing, suspension or sliding mechanism or a support stand to allow for a stable posture during the tool operation.

POINTS TO REMEMBER

Ensure that the workplace allows a stable posture with proper footing while using power-driven tools.

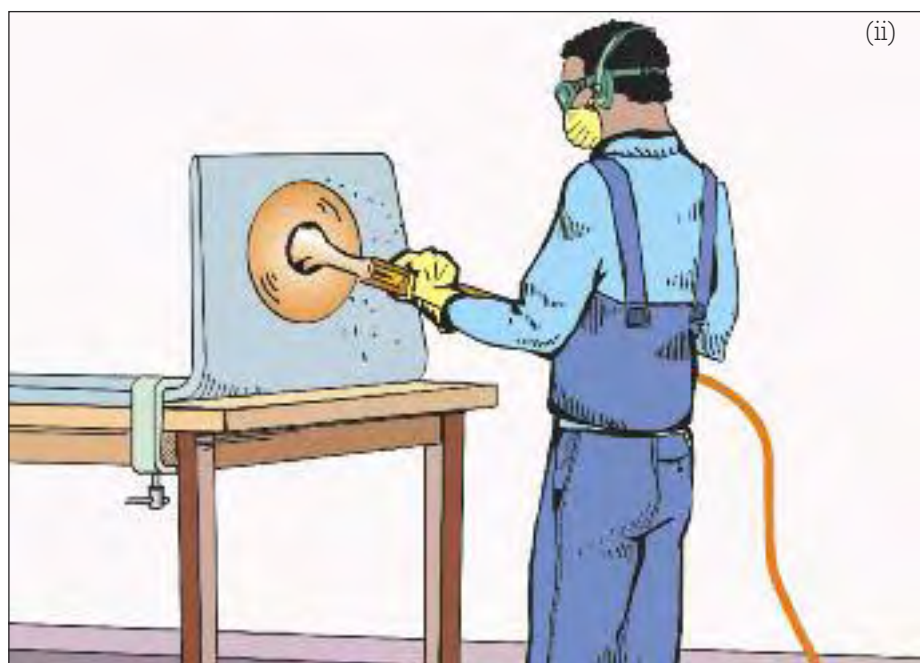

Figure 31. (i) and (ii) A stable posture with proper footing and appropriate work height around the elbow level is always necessary for safe and productive power tool operations.

Machine safety

CHECKPOINT 32

Design controls to prevent unintentional operation.

WHY

Unintentional operation of controls can cause serious injuries or damage, and lower productivity.

Unintentional operation can happen especially when many controls are situated in close proximity and the incorrect control is activated.

Where the layout and design of controls consider unintentional operation, workers feel more secure and can concentrate properly on their tasks.

RISKS / SYMPTOMS

- activating wrong control
- serious injury or accident

HOW

1. Design the layout of the controls to separate those that could be unintentionally activated.
2. Cover or “cage” controls that are likely to be turned on or off unintentionally.
3. Design a control that considers the possibility of unintentional activation. For example, if people are likely to activate a control accidentally by leaning on it and pressing, then select a control that requires pulling to activate it. Always consider that controls should still be moved in the expected direction.
4. Replace existing controls that can be unintentionally activated with controls that have more resistance and are harder to activate. However, the controls should not be so difficult to use that operators cannot activate the control when they want to do so.
5. Locate particularly important controls, such as power on-off or emergency switches, away from other controls. This helps avoid inadvertent activation during normal operations. Naturally, controls should still be within easy reach.
6. If there are controls or displays that are clearly superfluous and not used, remove them from the display panel.

SOME MORE HINTS

- Make sure covers and cages do not hide the control or confuse the worker. If the control protector makes the control difficult to see, consider using a clear or see-through device.
- When purchasing new equipment, look for machine designs that minimize unintentional activation. Useful designs include: mounded controls; recessed controls; controls that require two different actions (e.g. pull towards the operator and then pull towards the floor); or two controls that are required to be activated simultaneously.

POINTS TO REMEMBER

Turning a machine on or off unnecessarily is dangerous to people and bad for equipment, and slows production. There are different ways to prevent this unintentional activation.

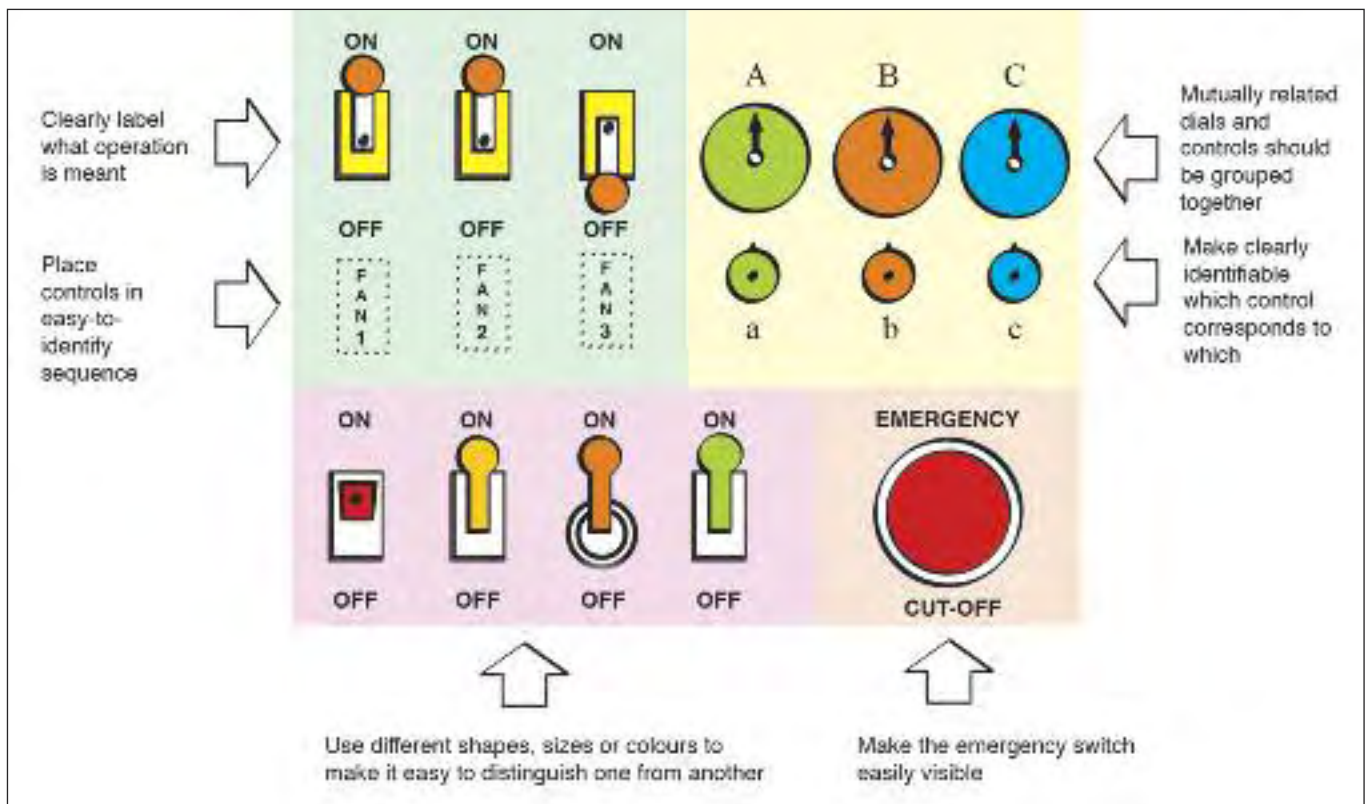

Figure 32a. Arrangement of dials and switches to minimize mistakes.

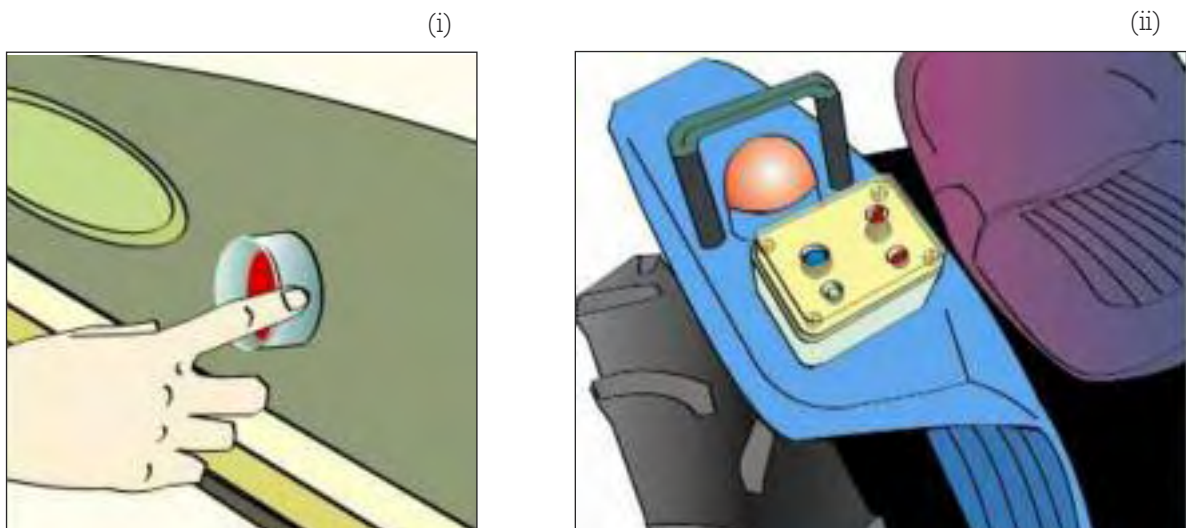

Figure 32b. (i) and (ii) Protect important controls from accidental activation, for example by providing a "cage" around each control or by adding a transparent cover.

CHECKPOINT 33

Make emergency controls clearly visible and easily accessible from the natural position of the operator.

WHY

Emergency situations are stressful, and operators are likely to make mistakes. Emergency controls must therefore be particularly well designed so that fast action is possible without any mistakes.

In an emergency, it may happen that the operator in charge is absent or injured. Co-workers who are trained in advance about emergency operation may have to act quickly. It is essential to make emergency controls easy to find.

Even untrained co-workers must be able to find emergency controls.

RISKS / SYMPTOMS

- activating wrong control
- performing wrong operation
- uncontrolled emergency
- serious injury or accident

HOW

1. Make emergency controls or cords easy to reach. Put them in a location that is natural for the worker to reach (e.g. not by twisting the body).
2. Make emergency controls large and easy to activate. For example, use a large rather than a small push-button.
3. Emergency controls should be labelled and coloured red or that colour identified by the local culture for emergency.
4. Check to make sure that these controls are in line with regulatory standards.
5. Position emergency controls away from other frequently used controls, thereby reducing the risk of inadvertent activation.

SOME MORE HINTS

- Many types of emergency control are used. In addition to palm buttons and emergency cords, a dead man's switch may be used. As long as the switch is actively pressed the machinery keeps going. If the pressure is released the machinery stops.
- Make it possible for the machine to switch itself off automatically in the event of a worker inadvertently coming into a danger area. For example, some rotating machinery has emergency trip-cords located above the operator's feet; if the operator is pulled into the machine, the feet will catch the trip cord and the machine will stop.
- Think of innovative ways to automate emergency action. For example, a worker could step on a "pressure mat".

POINTS TO REMEMBER

Emergency situations are very stressful. Even trained workers may make mistakes. Emergency controls must be designed so that there is no chance of mistakes in activating the controls.

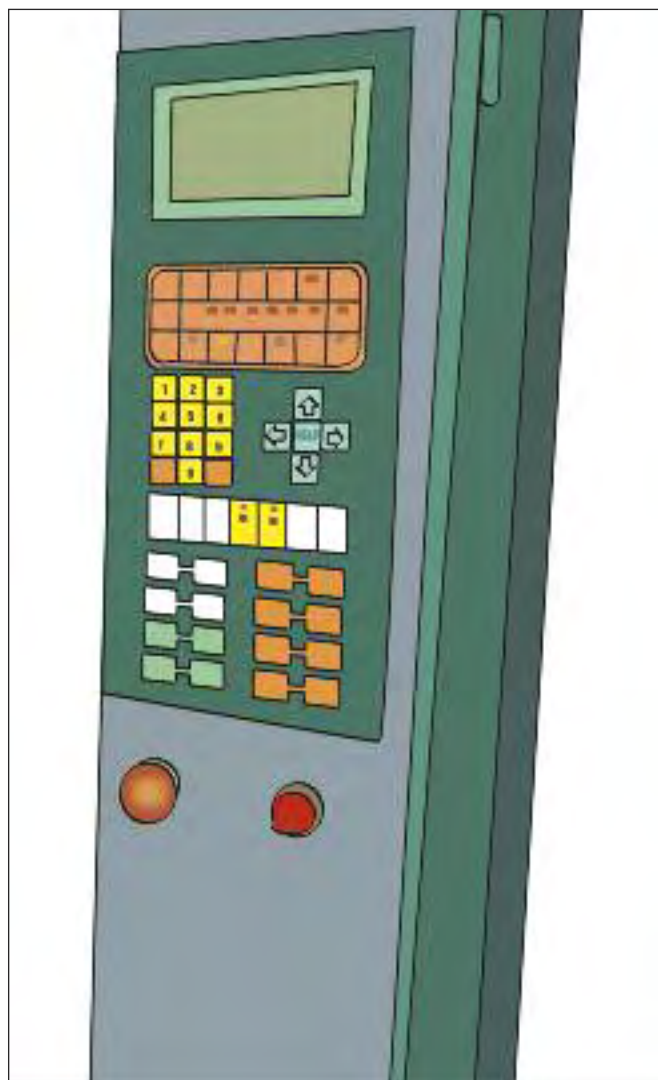

Figure 33a. Use different groups of controls to make it easy to distinguish them, while placing the emergency stop switch separately in a clearly visible manner.

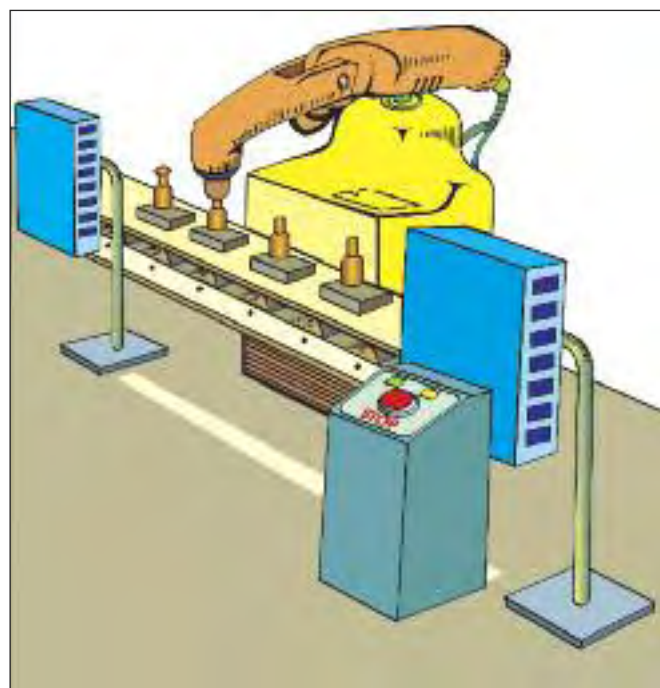

Figure 33b. Make emergency switches easily visible.

CHECKPOINT 34

Make different controls easy to distinguish from each other.

WHY

If controls look similar, people will make mistakes. Activation of a wrong control may lead to an accident.

Controls that are quick and easy to find will save time and reduce operator errors.

Controls are sometimes easy to distinguish just because they have different locations. But often this is not sufficient. By adding another feature, such as colour, size, shape or labels, controls are much easier to distinguish from each other. This is called “coding” of controls.

RISKS / SYMPTOMS

- activating wrong control
- performing wrong operation
- serious injury or accident

HOW

1. Use different colours, sizes or shapes for switches and other controls:
 - use different colours for different controls;
 - use controls of different sizes;
 - use control knobs of different shapes.
2. Label the controls. Attach clearly visible, simply worded labels. Use labels written in the local language.
3. Standardize the location of common controls on similar machines. For example, place controls in an easy-to-identify sequence (from fan 1 to fan 2 to fan 3, etc.) or in a place where it is easy to identify which control corresponds to which display (placing the heat-controlling knob directly under the temperature dial, etc.). In this way, the control panels for similar machines should also look alike. This will reduce errors in operation.

SOME MORE HINTS

- Make emergency controls (such as an emergency cut-off switch) look very different and easily visible by means of colour, size and shape.
- Use no more than three different sizes of control knob, because people cannot distinguish more than three sizes.
- The shape of a control knob can be made to look like the controlled function (e.g. a control for a fan can look like a fan).
- Colour coding does not work in dark environments.
- Labels can be put above, underneath or at the side of controls, as long as they are clearly visible.

POINTS TO REMEMBER

Coding of controls (by colour, size, shape, label and location) can prevent operator errors and reduce the time for operation.

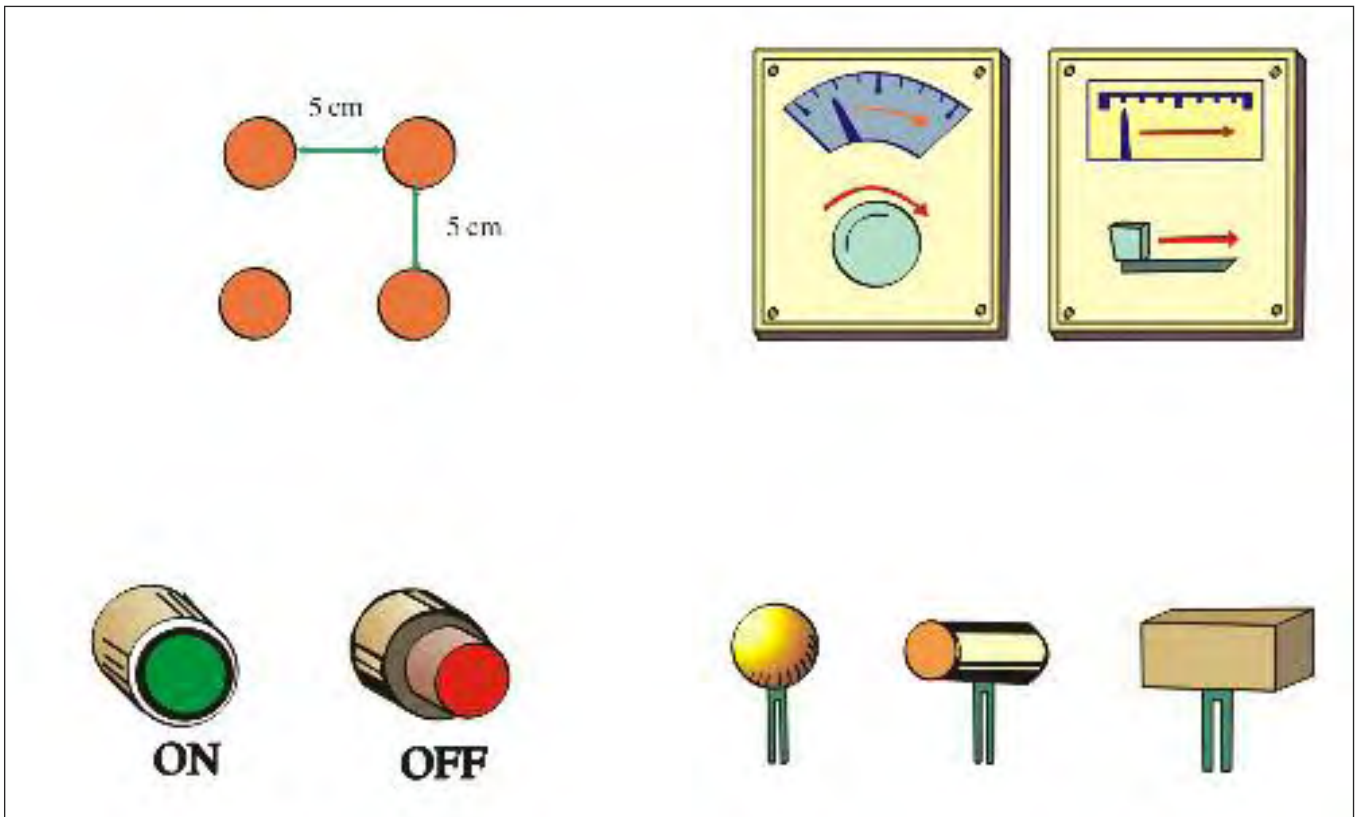

Figure 34a. Try various ideas to make different controls easy to distinguish from each other. Grouping, keeping good control-display relationships, spacing, different shapes and different colours are all useful ideas. Making emergency “off” switches easy to distinguish is particularly important.



Figure 34b. Examples of making different controls easier to distinguish from each other by changing their shapes and colours.

CHECKPOINT 35

Make sure that the worker can see and reach all controls comfortably.

WHY

All items that are touched by the hands need to be organized. In many cases workers themselves organize these items at the workstation, but often they do not.

If controls are not easy to see or reach, operators tend to use them by relying on habits and guesswork. This can cause mistakes.

Time and effort are saved by placing controls within easy reach. Controls placed too high cause shoulder pain, and controls placed too low cause back pain. It is important to locate them in a place that is easy to reach from a normal working posture.

RISKS / SYMPTOMS

- excessive reach
- muscular strain
- activating wrong control
- upper limb disorder

HOW

1. Place the most frequently used controls or controls used for most of the time in front of the operator so that the control operation is done at around elbow height without bending or twisting the body.
2. Controls of secondary importance may be placed next to the most important controls. In any case, they should be within easy reach from the normal working position. Avoid places where twisting of the body becomes necessary for operating the controls.
3. If control positions are too high, use a platform to raise the floor on which the worker stands or sits for work. If control positions are too low, try to raise them by relocating them or putting a platform under the machine or workbench.
4. When new workstations or new machines are introduced, purchase those that are suited to the size of the operators or those in which the workstation or control heights are adjustable. Most

work operations are best done around elbow level. This “elbow rule” can be applied to determine the correct hand height during operations.

SOME MORE HINTS

- It is useful to identify the primary hand movement area. This is between 15 and 40 cm from the front of the body and within 40 cm from the side of the body at elbow height. The secondary hand movement area is beyond the primary area but within 60 cm from the side of the body at elbow height. Position the primary controls and other primary items (hand tools, parts) within the primary area, and secondary controls and other secondary items within the secondary area.
- See that the controls are located in a good combination with other items, such as tools, parts to be grasped, semi-products to be placed on the workstation, bins, etc. Try to organize the layout of all these items based on the opinion of the experienced workers.
- The work-table surface may sometimes be divided into subtask areas where operations are done sequentially. This helps to organize the task and facilitates learning and productivity.

POINTS TO REMEMBER

A well-organized workstation will save time and is productive. The location of controls according to their primary and secondary importance helps to organize workstations.

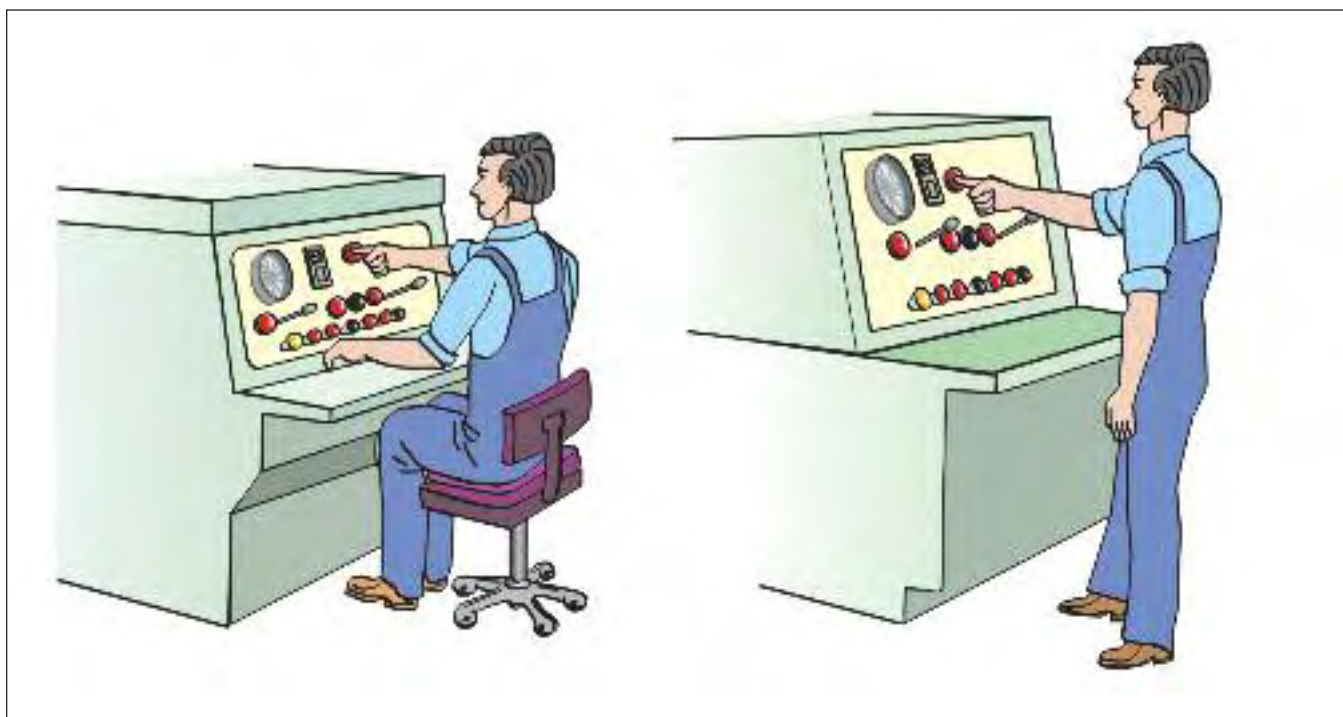

Figure 35a. Ensure that workers can reach all controls comfortably from a standing or sitting position.

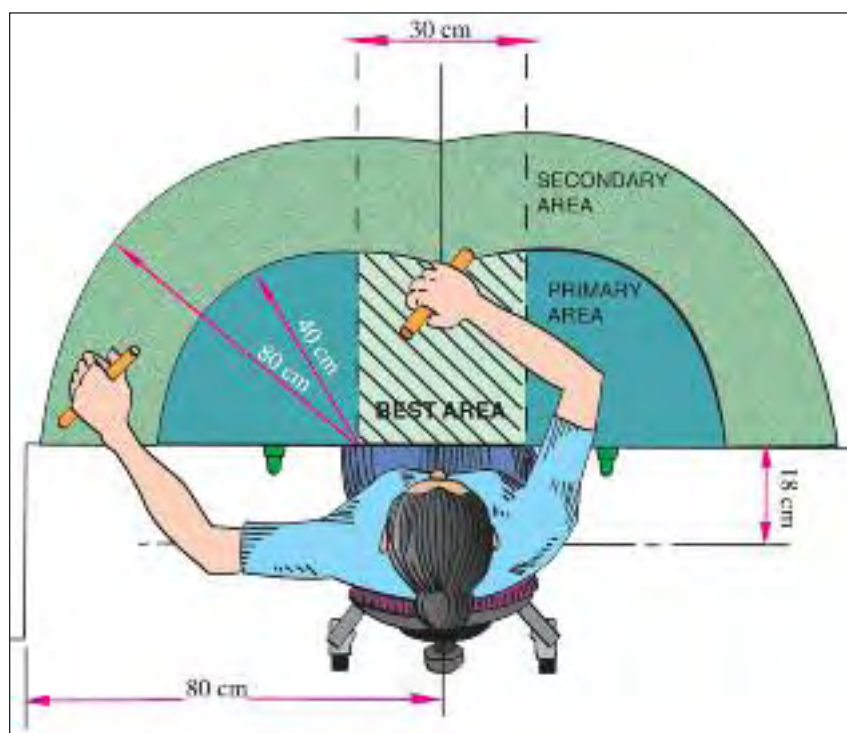

Figure 35b. All controls need to be within easy reach of the worker and easy to see.

CHECKPOINT 36

Locate controls in sequence of operation.

WHY

Some machines have multiple controls that are difficult to learn to operate. For example, hydraulic equipment used in mining or manufacturing may have 10–12 controls. The sequence of control operations can be made easy to learn if controls are positioned to follow the task.

When multiple controls correspond to multiple machines or machine parts, controls are often confused. This can be avoided by locating controls in the same sequence as they are operated.

By placing controls in a logical sequence, it is easier to standardize their locations between similar machines. This greatly facilitates learning.

RISKS / SYMPTOMS

- activating wrong control
- performing wrong operation
- serious injury or accident

HOW

1. Identify subtasks in machine operation, such as “power on-off”, “setting up”, “operating” or “moving machine”. See if controls for each subtask are easy to distinguish from those for other tasks.
2. Reposition controls by changing electrical connections (or even changing hydraulic hoses, if possible) so that controls associated with each subtask are grouped together.
3. Position controls according to the sequence of operation within each subtask (e.g. position controls A, B and C in this sequence when the corresponding operations A, B and C are done in the same sequence).
4. Similarly, position controls according to the different machines or machine parts (e.g. position controls A, B and C in the same sequence as the corresponding machines A, B and C).

5. Code the controls by colour, size, shape or label to make it easier to distinguish between them.

SOME MORE HINTS

- Workers sometimes modify controls or control knobs to make them easier to operate. Look out for such modifications, because they indicate that there is a need for change.
- Make a list of the different subtasks and the sequence of control operations. Ask the worker to help out and verify this information. Then consider if changes in location will be useful.
- Ask the workers if controls corresponding to different operations are easy to find without mistakes. If not, try to change their locations or introduce coding.

POINTS TO REMEMBER

Workers will make fewer errors if controls are located in an easy-to-understand sequence. This improves both safety and productivity.

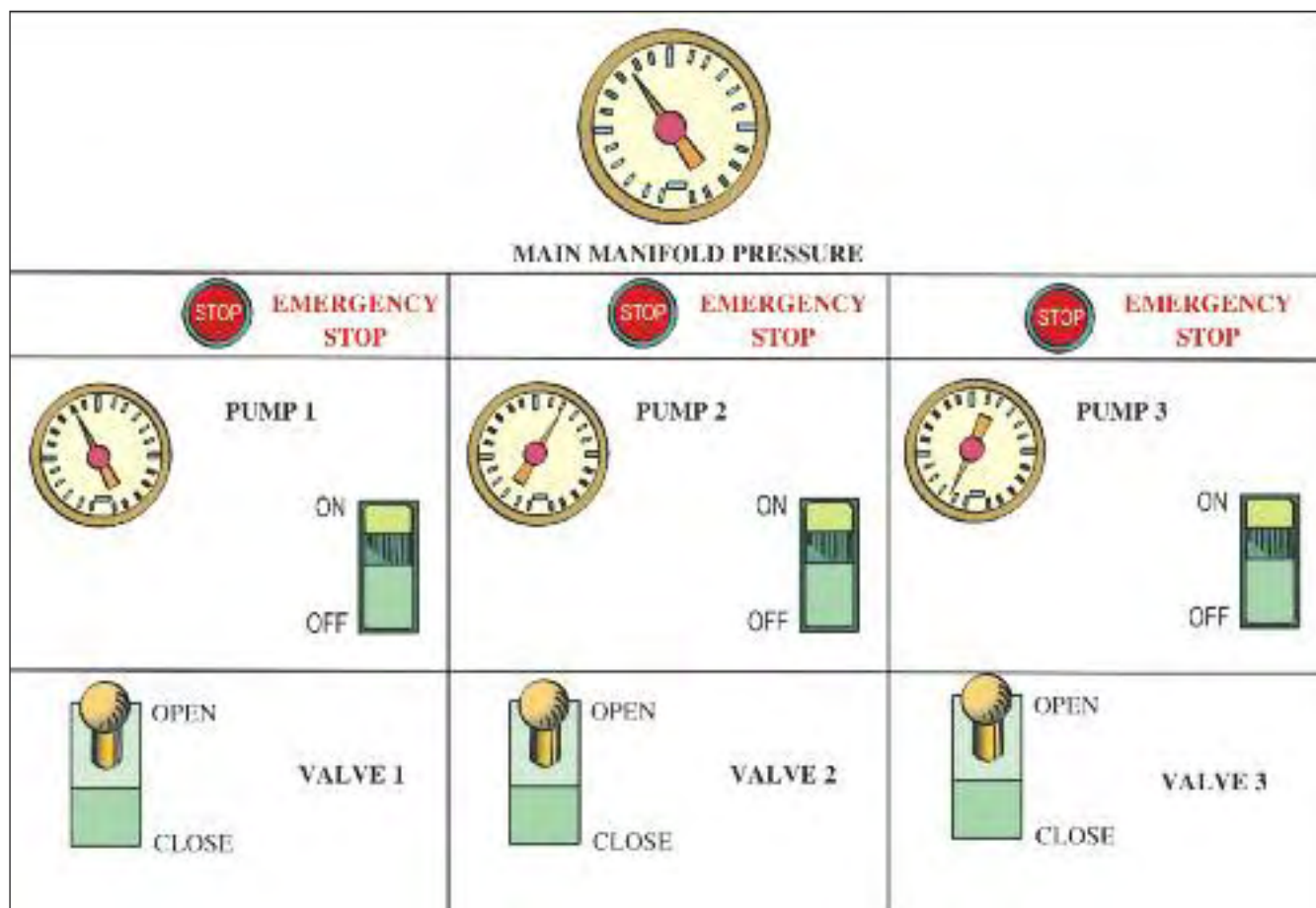

Figure 36. Group together the controls associated with a particular subtask. This makes it much easier to locate them.

CHECKPOINT 37

Use natural expectations for control movements.

WHY

Most people have expectations of how a control should be moved.

In a car, there is a clear expectation to move the steering wheel in the same direction as the road turns. A car designed differently would be a disaster. The same principles apply to machine controls.

Note that expectations may be different in different countries. For example, in many countries (e.g. India) a light switch is turned down to turn on the light, while in others (e.g. the United States) the light switch is turned up.

RISKS / SYMPTOMS

- activating wrong control
- performing wrong operation
- serious injury or accident

HOW

1. Use the expectations in the following table.

<i>Desired action</i>	<i>Expected control movement</i>
Turn something on	Right or forward or clockwise or down (up in some countries)
Turn something off	Left or back or anti-clockwise or up (down in some countries)
Move something right	Right or clockwise
Move something left	Left or anti-clockwise
Raise something	Up, back
Lower something	Down, forward
Retract something	Pull back or up
Extend something	Push forward or down
Increase something	Up or right or clockwise
Decrease something	Down or left or anti-clockwise
Open a valve	Anti-clockwise
Close a valve	Clockwise

2. Make sure that the control movements of different machines or power switches use the same principles.

SOME MORE HINTS

- Some control expectations are more “natural” than others. For example, to raise an overhead crane a vertical control would move up and down, but a horizontal control would move forward and backward. For the horizontal control there is a one-to-one correspondence between the movement of the control and the crane. This is a strong expectation.
- For a horizontal control that pulls back and forth, expectations would be more mixed, because there is no clear one-to-one correspondence. A few people would probably push the control forward to raise the crane. It is better to avoid this confusing control movement.
- Keep the dial movement and control movement corresponding with each other. For example, if the dial pointer moves to the right by increasing something, the control placed beneath should also be moved to the right (or clockwise) to increase it.

POINTS TO REMEMBER

People have expectations of how to move controls. Do not violate them. Use these expectations to your advantage to reduce control errors and to make production more effective.

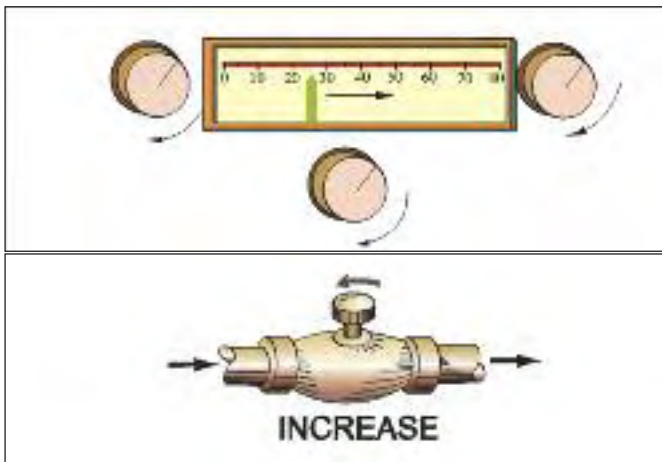

Figure 37a. There are certain established relationships between control movements and the decrease-increase effects. Ensure that they are in accordance with understanding of local workers.

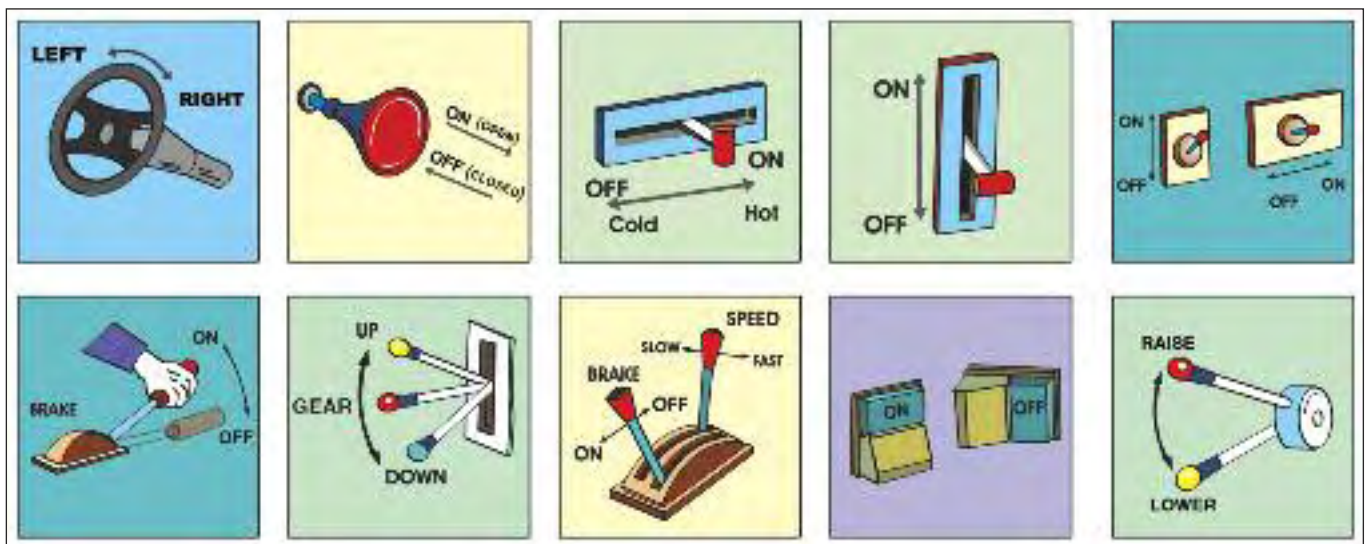

Figure 37b. Use natural expectations for control movements. Be aware that these expectations may differ between different populations. For on-off movements, follow the local habits, but with clear “on” and “off” signs. For right-left, up-down and other movements, make sure that workers fully understand the correct directions.

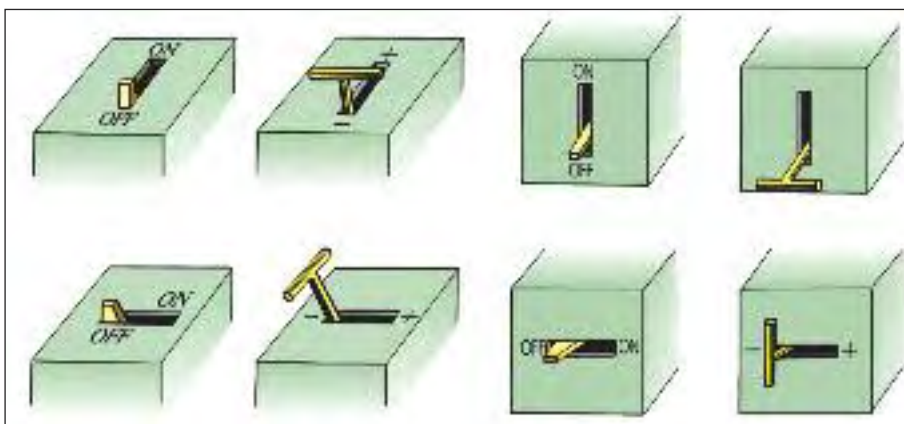

Figure 37c. Direction of controls that are easy to understand for most people. Adding signs is always helpful.

CHECKPOINT 38

Limit the number of foot pedals and, if used, make them easy to operate.

WHY

Foot pedals can be useful as alternatives to hand controls. They are particularly useful when both hands are busy. The use of foot controls can also free space in a workstation. Foot controls, however, often require keeping a special posture and thus restrict the operator's movement. This is particularly critical for standing operators.

Foot pedals that are operated repetitively by one foot cause one-sided strain, which may lead to back pain.

Foot pedals cannot be easily seen from the normal working position. Special care must be taken to prevent stumbling or inadvertent activation.

RISKS / SYMPTOMS

- muscular strain
- low back pain
- slips, trips or stumbles
- leg/foot injury

HOW

1. Limit the number of foot pedals to a minimum when their use is necessary. Avoid as much as possible foot pedals that are operated repetitively by one foot only.
2. Locate a foot pedal at floor level in order to avoid uncomfortable foot positions. A pedal level that can be reached only by raising the foot away from the floor is uncomfortable, and forces the worker to maintain an unnatural posture.
3. Make it possible to move the location of a foot pedal on the floor.
4. Make the foot pedal large enough to fit the sole of the foot.
5. Consider using a footrest at the side of the pedal.

SOME MORE HINTS

- Foot controls are good for many applications if adequate care is taken about the working posture and ease of operation. They are even used as a cursor control for computers (a "foot mouse").
- Be careful in locating foot controls, because they can be a tripping and falling hazard.
- Adjustability of the location of a foot pedal is important to improve workers' comfort and convenience. This is helpful especially for standing operators.

POINTS TO REMEMBER

Foot controls are beneficial when the hands are busy with other tasks, and where there is limited space at the workstation. Make it possible to adjust the location of a foot pedal on the floor, particularly for standing operators.

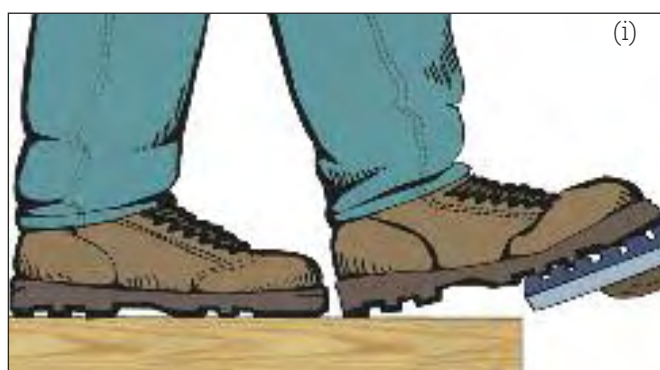

Figure 38a. (i) and (ii) Locate a foot pedal at floor level and make the pedal large enough for easy operation.

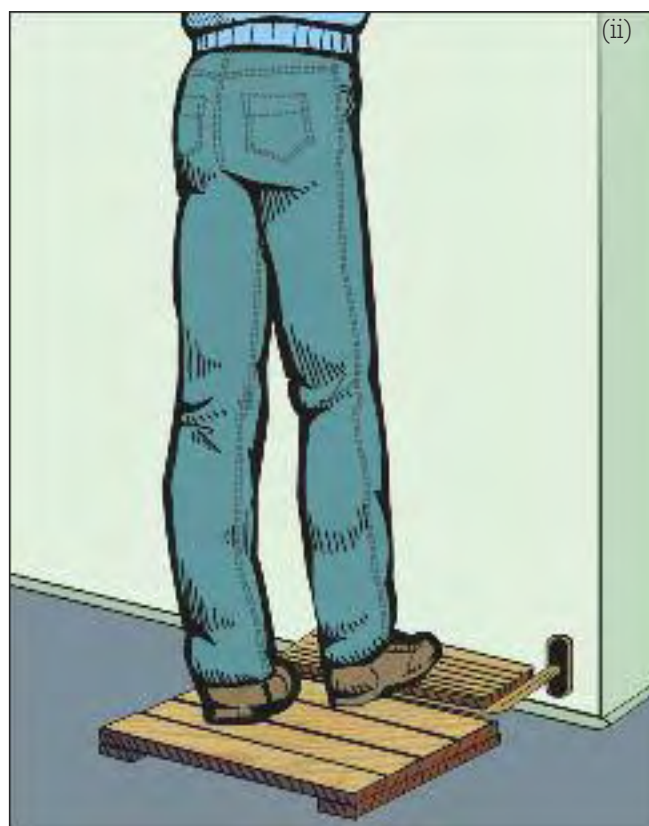

Figure 38b. (i) A pedal level that can be reached only by raising the foot away from the floor is tiring. (ii) Make the pedal level lower and provide a foot platform for easy pedal operation.

CHECKPOINT 39

Make displays and signals easy to distinguish from each other and easy to read.

WHY

Displays and signals carry information about work, and they should be easy to identify. It is important to consider the location of displays and signals, and also to make them easily distinguishable from each other.

Good visibility of pointer positions, characters and numbers on displays or signals also ensures high-quality work.

Incorrect reading of displays or signals is sometimes critical, as this may lead to operation failures and accidents.

RISKS / SYMPTOMS

- performing wrong operation
- missing signal or display change
- serious injury or accident

HOW

1. Put important displays or signals where operators are normally looking. Locate the most important ones at a viewing angle of about 20–50 degrees below the horizontal line from the operator's eyes.
2. Use different sizes, shapes or colours when different displays or signals are used by the same operator. Using colours for coding different information is often the easiest way to do this.
3. Make the characters and numbers large enough so they can be easily read at a distance. For example, for an operator viewing a display at 1 m distance in good illumination (say, 500–800 lux, as in the case of a well-lit office), a character height of 5–10 mm is appropriate. As viewing distances increase or reading conditions get worse, the size of characters should be increased.
4. Use display markers that are easy to read. Very detailed marks and crowded numerals disturb the reading. It may sometimes help to use different colours for different sections of a display.

SOME MORE HINTS

- Displays located in the peripheral viewing field are difficult to monitor. For example, if a display is located at more than 50 degrees from the central viewing point, the operator must turn their head to read the display. Under such conditions operators make more errors or even omit reading the displays.
- Good location of the displays, controls and corresponding machines is important. Use a layout for displays so that it is easy to understand the relation to machines and controls. It is very useful to group related displays and place them in sequence of operation. For example, displays placed just above the corresponding controls greatly help the operator in finding the control.
- Ensure good lighting on displays and signals in the evening or night hours.
- Displays can often be shown by means of a visual display unit (VDU). Presentation on a VDU screen offers an extra challenge, because the screen is small. Displayed information that is easy to understand and easy to read is equally important on VDU screens.

POINTS TO REMEMBER

Displays should be put in a location where operators look. Make different displays easy to distinguish from each other. Characters and scale markings must be of adequate size and clearly visible from the normal position of the operator.

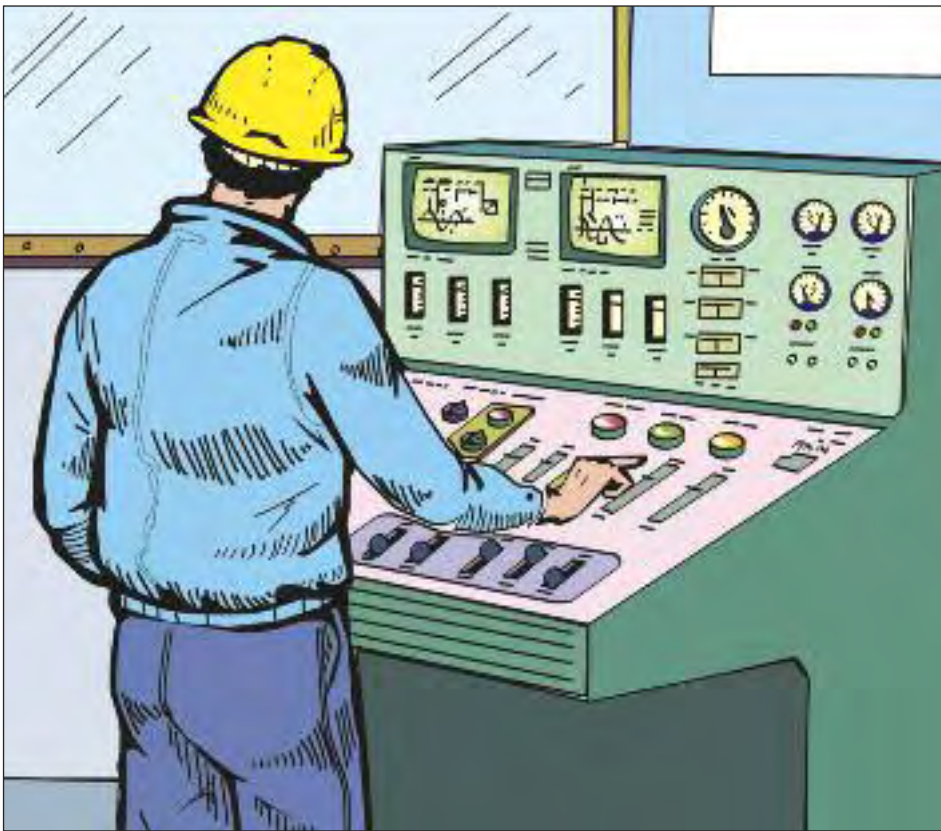

Figure 39a. Locate the most important displays and signals at a viewing angle of about 20–50 degrees below the horizontal line from the eyes of the operator standing or sitting naturally.

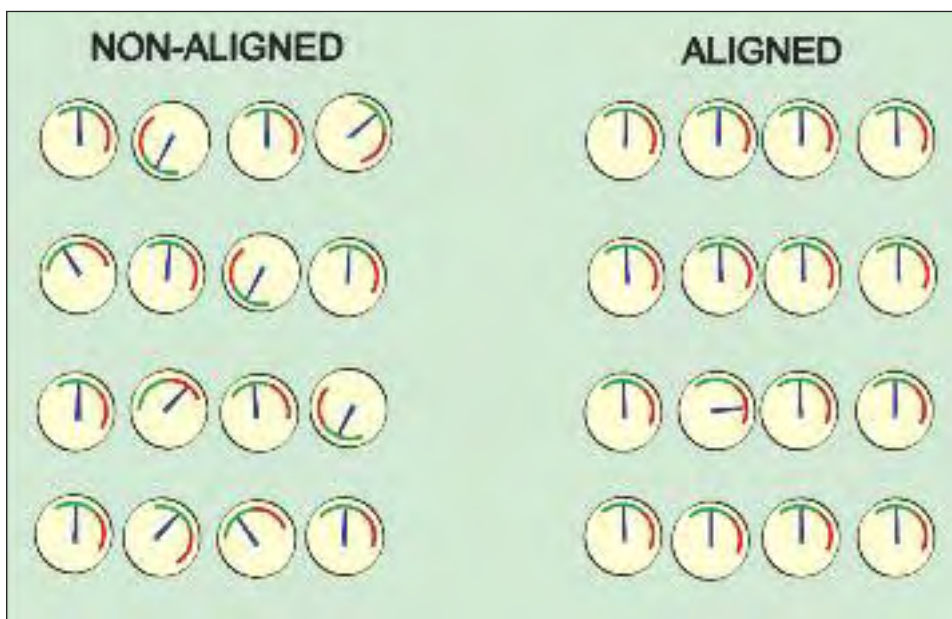

Figure 39b. If appropriate, select the pointers' normal positions so that they are easy to identify.

CHECKPOINT 40

Use markings or colours on displays to help workers understand what to do.

WHY

For some tasks it may be necessary to display an exact numerical value, such as time in minutes. For other tasks it is enough to know if the value is within a certain range. One example is water temperature. It may be enough to know that the temperature is below boiling point.

Displays are there to help a worker carry out the right operation. Often workers themselves add markings to displays. Use these ideas to change displays to "helpful displays".

RISKS / SYMPTOMS

- performing wrong operation
- missing signal or display change
- serious injury or accident

HOW

1. Add markings to indicate the point or ranges where a certain action is always necessary (e.g. temperature or speed limit).
2. Use colour coding. For example, green areas or numbers mean acceptable. Red means unacceptable.
3. Group related displays together and organize them for easy inspection. For example, a break in the pattern of pointer positions is easy to see (e.g. if horizontal or vertical positions of all the pointers in the group mean that the operation is progressing correctly, then it is easy to find a pointer deviating from this pattern).

SOME MORE HINTS

- Usually two different types of display are available: (i) a counter with numbers; and (ii) a moving-pointer display which shows an approximate value. A moving pointer is appropriate for showing trends and changes (such as increases or decreases). In this case, the operator is not interested in detailed numbers.

- Position important displays where operators will normally be looking.
- Avoid parallax effects that occur when the position of a moving pointer somewhat above the dial surface is wrongly read by an operator looking at the dial from the side. Place the dial surface vertical to the line of vision or place such important displays in front of the operator.

POINTS TO REMEMBER

Displays should tell workers what to do. Use markings or colours for this purpose.

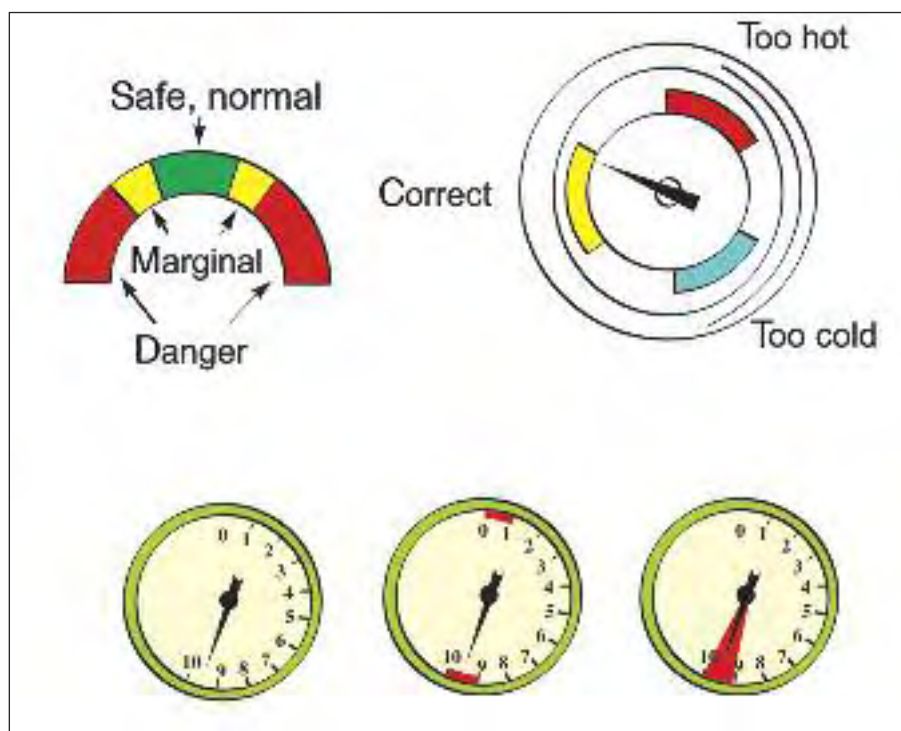

Figure 40. A display instrument should convey the required information as simply and unmistakably as possible.

CHECKPOINT 41

Use symbols only if they are easily understood by local people.

WHY

Symbols are sometimes used to identify machines, chemicals, controls and displays. In fact, many international manufacturers of machines prefer to use symbols, because they do not have to translate a label into the local language. But many symbols are difficult to understand, particularly those referring to machine functions that are hard to visualize or imagine. It is often better to use a short message instead.

Good symbols can be used insofar as they are easily understood by local people.

RISKS / SYMPTOMS

- performing wrong operation
- missing signal or display change
- serious injury or accident

HOW

1. Use symbols only if you are absolutely sure that they are easily understood by all the workers concerned.
2. Simple symbols are better, but be aware that there are not many symbols that are universally understood.
3. Take several workers, one at a time, to the machine and ask them to identify the symbols. If a symbol is understood by all workers, there is no problem. If it is not understood by some workers, make a label and attach it to the machine.
4. Do not hesitate to add labels. They will prove essential in critical situations. Labels should be designed in accordance with local culture and stereotypes. The labels should be made to withstand wear and tear. Metal or plastic plates are the best solution.

SOME MORE HINTS

- Well-understood symbols have an advantage in that they are quicker to read than a label. There are widely accepted and widely used symbols, as in the case of no smoking signs, emergency exits and hazardous chemicals.
- If you want to propose your own symbols, get workers to evaluate them.

POINTS TO REMEMBER

Symbols that are difficult to understand should be supported by labels. If in doubt, ask the workers.

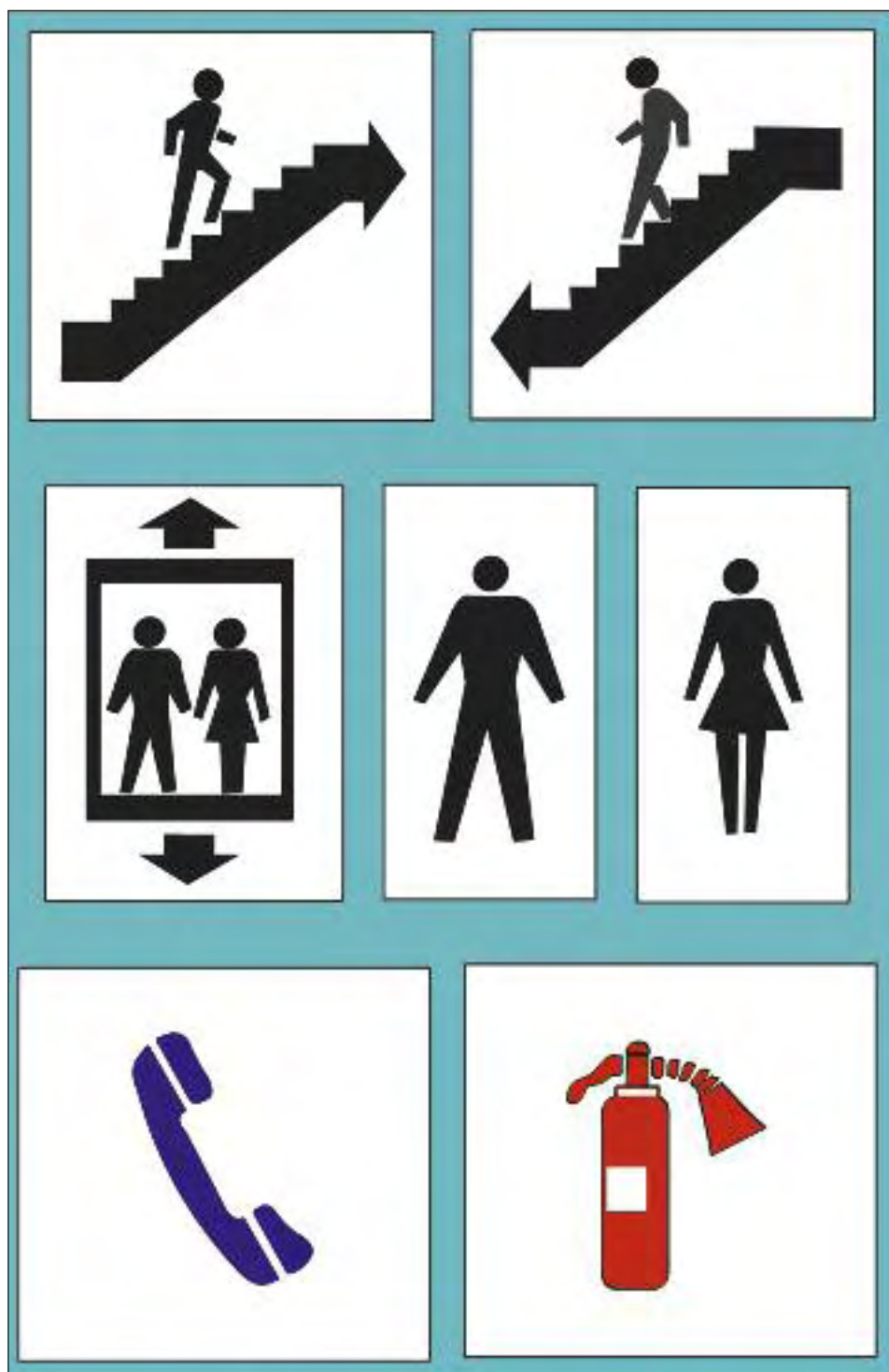

Figure 41. Use symbols that are easily understood by local people and consistent with ISO signage.

CHECKPOINT 42

Make labels and signs easy to see, easy to read and easy to understand.

WHY

Labels and signs must be easy to read, otherwise they will be ignored.

People tend to read labels and signs only at a short glance, and therefore often make mistakes in reading them. This may lead to performing the wrong operation and may cause an accident. Labels and signs must be large and clear enough to be easily read at a distance.

Text must be made easy to understand so that people will know what to do. This is productive because it will save time.

RISKS / SYMPTOMS

- performing wrong operation
- missing signal or display change
- serious injury or accident

HOW

1. Locate labels and signs in places where people often look, for example close to the production process or in front of each operator.
2. In a workplace where the operator stays in the same place, locate labels and signs at a comfortable viewing angle from that position, i.e. about 20–40 degrees below the horizontal.
3. Make the lettering large enough to be easily read at a distance.
4. Where appropriate, use different colours or shapes for different labels or signals.
5. Put labels for displays and controls immediately above, underneath or to the side so that it is clear which label corresponds to which display or control. Make sure that these labels are not obscured by other elements.
6. Make the message clear and short. Avoid confusing and lengthy text.

7. Make sure that labels and signs use language that can be understood by the workers. Where there is more than one language group, it may be necessary to use different languages in labels and signs.

SOME MORE HINTS

- Locate labels and signs so they do not pick up reflections from light sources, which can cause glare. Sometimes you can change the angle of a sign to reduce reflections (as for a rear-view mirror in a car).
- Use materials such as plastic or steel that can easily be cleaned of dirt and oil, and so that the sign will remain visible for years to come.
- Labels with 1 cm high lettering are normally sufficient at workstations.
- When indicating a required operation, start the message with an action verb so that people know exactly what to do (e.g. “Turn off lights”, “Hook the sling”, not “Turn off lights if not necessary” or “Danger – Watch the crane”).

POINTS TO REMEMBER

Labels and signs can give much important information. Locate them where the workers look, make them large enough, and make the message short and easy to understand. This will reduce errors and save time.

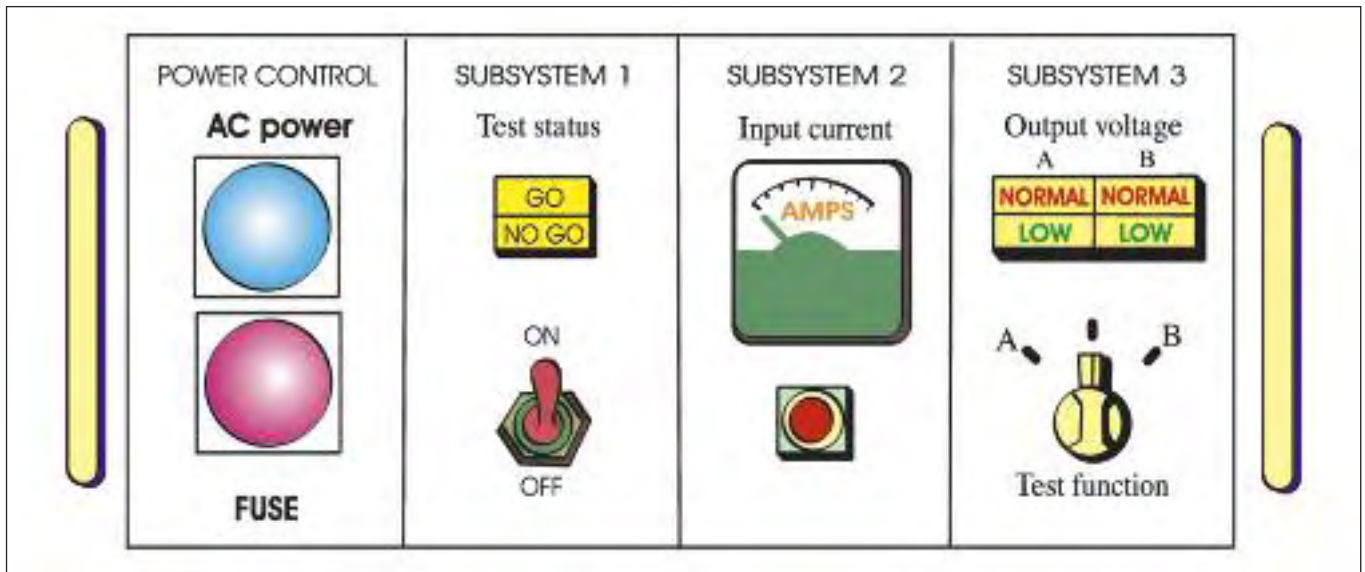

Figure 42a. Labels and signs should be easy to see and easy to read.

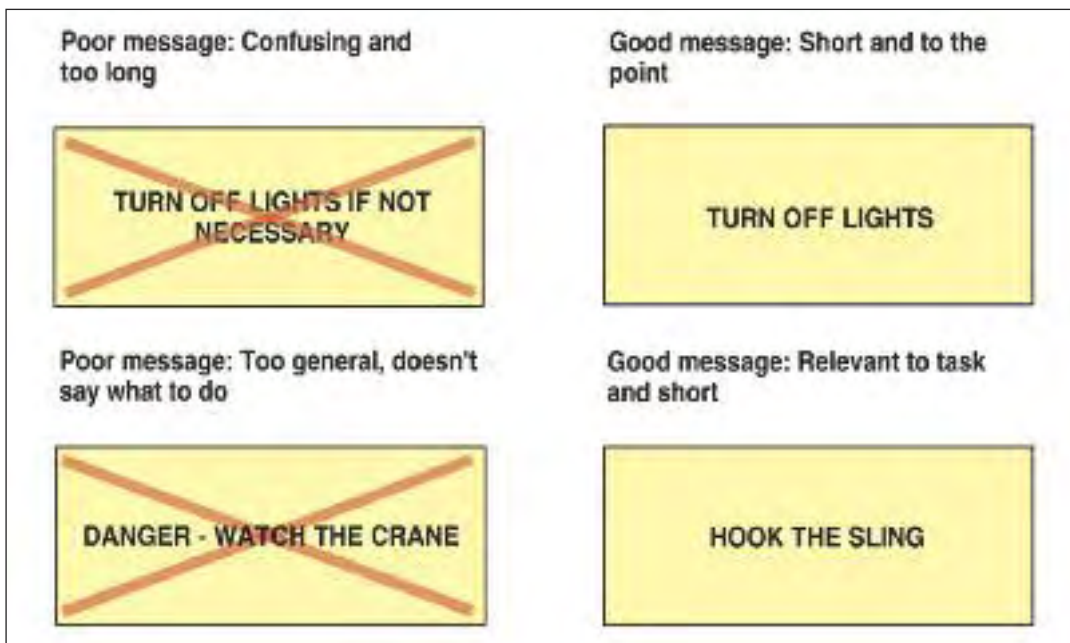

Figure 42b. Labels and signs should be short and to the point.

CHECKPOINT 43

Use warning signs that workers understand easily and correctly.

WHY

Warning signs are used to warn against hazards. They often carry a complex message, because it is necessary to convey what the hazards are and what the person should do to avoid them. Make sure that warning signs are easily understood by workers.

Lengthy warning signs are in fact not read by all workers. It is important to choose compact but easy-to-understand messages.

RISKS / SYMPTOMS

- serious injury or accident
- electrocution
- delayed evacuation

HOW

1. Use a warning sign that contains four essential elements:
 - a. A *signal word* – to convey the gravity of the risk, for example “Danger”, “Warning” or “Caution”. “Danger” is the most severe signal word and “Caution” the least.
 - b. The hazard – the nature of the hazard.
 - c. The consequence – what could possibly happen.
 - d. An instruction – what is the appropriate behaviour to avoid the hazard.
2. Ensure that the appropriate signal word – such as “Danger”, “Warning” or “Caution” – is used. Also make sure that the descriptions of the nature of the hazard and the consequences are appropriate. Check if the instruction to workers about what to do is clear enough.
3. Get workers to evaluate existing warning signs. You will gain many useful suggestions.

4. The effectiveness of warning signs can be enhanced by symbols. An example of a good warning sign:

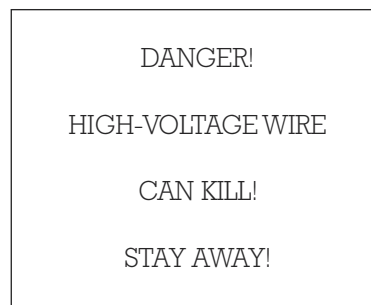

SOME MORE HINTS

- Note that short messages are more effective than long ones.
- General warning signs, such as those that merely say “Danger”, “Look out” or “Warning”, are not effective. They are too general, and people do not understand what to do.
- Written warning signs assume that workers are able to read. When easy-to-understand symbols are available, use both symbols and written signs.

POINTS TO REMEMBER

Warning signs must spell out what the danger is and what to do.

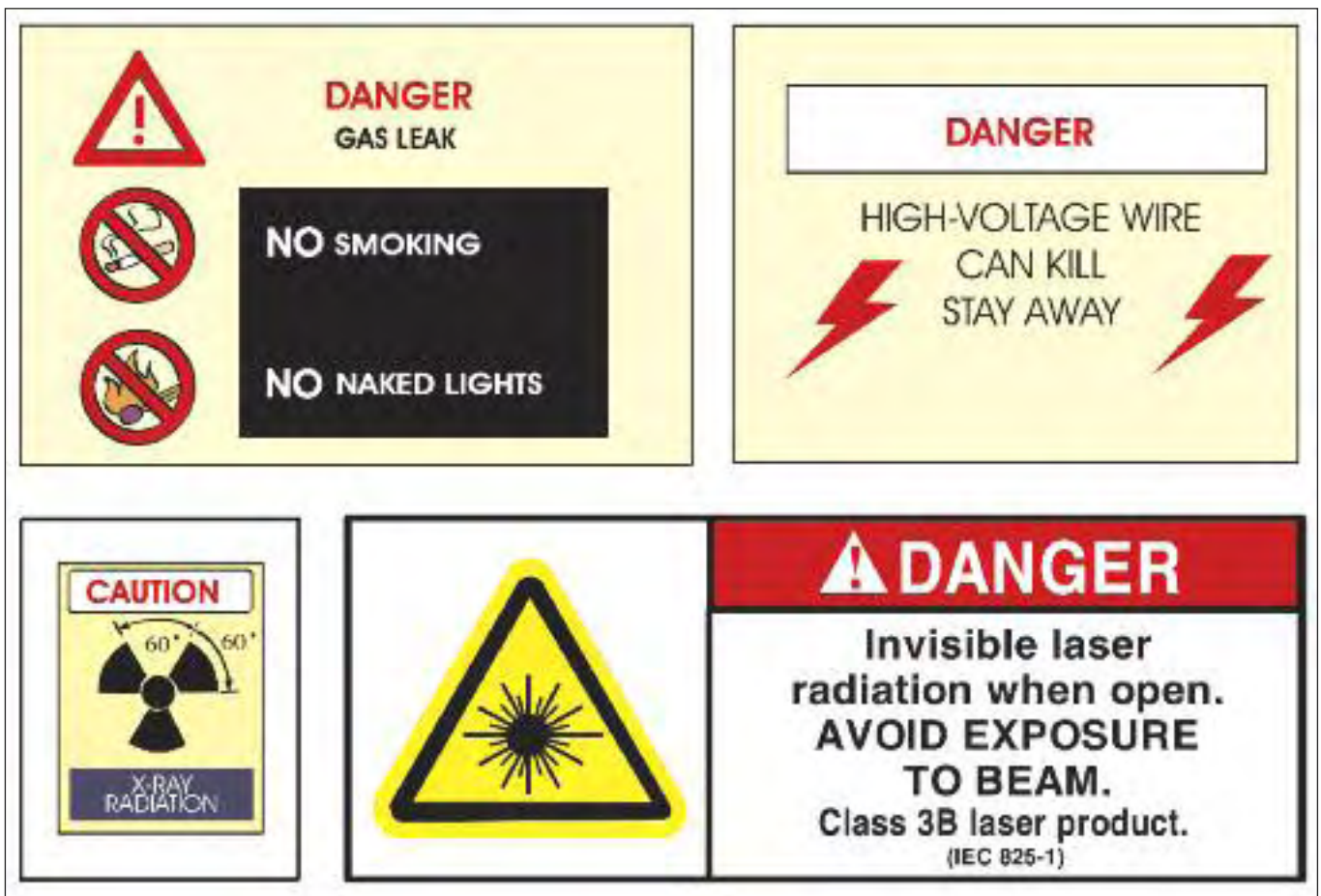

Figure 43. Warning signs should use short messages that indicate the nature and gravity of the hazards, and what to do or what not to do.

CHECKPOINT 44

Use jigs and fixtures to make machine operation stable, safe and efficient.

WHY

Jigs and fixtures hold work items firmly in correct positions. They make the operation more stable and more efficient.

Fixtures leave both hands free to work.

Jigs or fixtures keep the hands away from tools or operational sections of the machine. This is because the jigs or fixtures, and not the hands, hold the work items. This increases safety and efficiency.

RISKS / SYMPTOMS

- muscular strain
- repetitive strain
- upper limb disorder
- hand/finger injury

HOW

1. Design a jig that guides a tool or an operating part of the machine to a precise location on the work item. This will increase efficiency.
2. Alternatively, use a fixture that holds one or more items for processing. This frees the hands.
3. Always use jigs and fixtures in such a way that they firmly hold the workpiece while preventing its movement in either direction along the X,Y and Z axes, and rotation in either direction about the X,Y and Z axes.
4. Make the jigs and fixtures easy to load and unload.
5. Standardize components of jigs and fixtures (bases, bushes, pins, clamps) to minimize costs and speed repairs.
6. Establish a plan to maintain jigs and fixtures properly and make it clear to all concerned workers, so that they know what to do if the parts in the jigs or fixtures are defective (whom to contact, etc.).

SOME MORE HINTS

- As the jig or fixture weight increases, consider mechanical handling instead of manual handling.
- Chamfer sharp edges.
- Make jigs and fixtures sturdy, as they tend to get rough treatment. Use wear strips on the base where they are in contact with a conveyor. Use plastic or rubber "bumpers".

POINTS TO REMEMBER

Don't use the hand as a fixture. For that purpose, use a jig or a fixture.

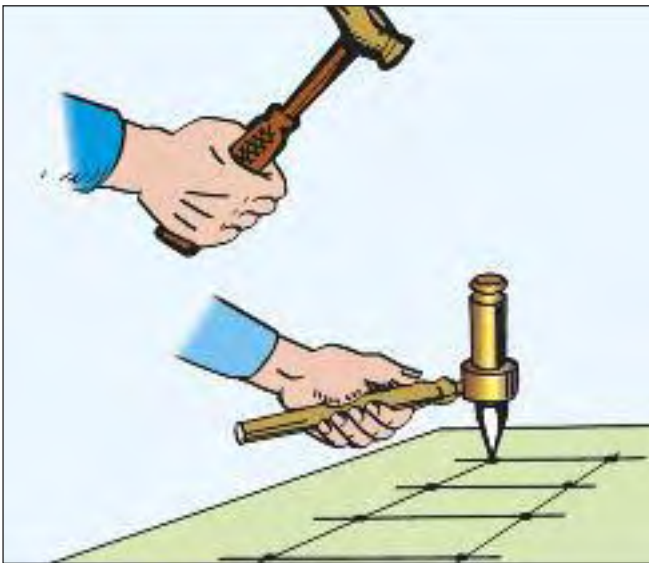

Figure 44a. Hand-held tools can be stabilized, making the job easier to perform.

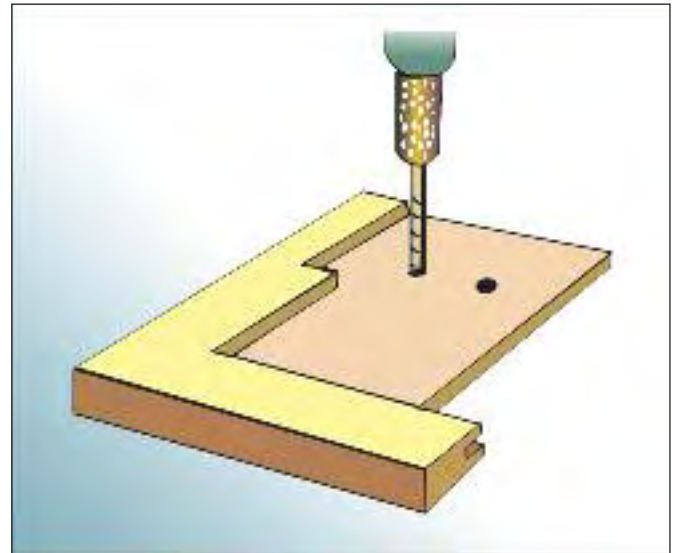

Figure 44b. Use a specially designed or universal jig or fixture instead of holding an unstable workpiece by hand.

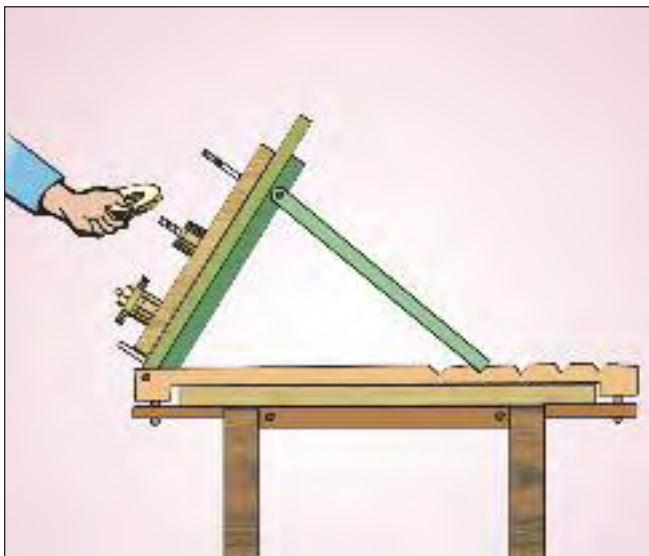

Figure 44c. Fixtures that stabilize operations can often be simply designed.

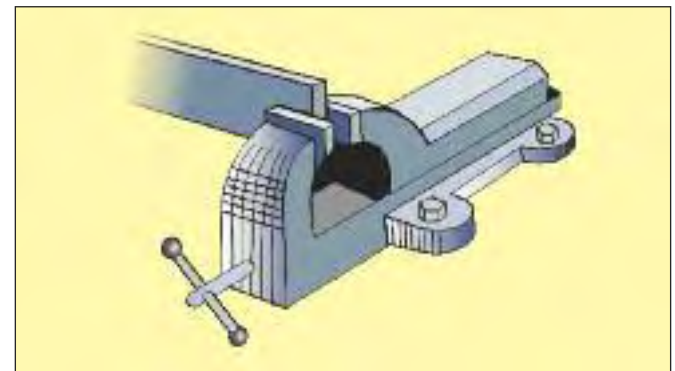

Figure 44d. Clamps and vices can hold different sizes and shapes of workpiece steady during work, and can free the hands as well.

CHECKPOINT 45

Purchase machines that meet safety criteria.

WHY

There are safe and unsafe machines. Care should be taken to purchase machines that are constructed safely.

Safe machines are machines in which dangerous parts are situated in a position where they cannot harm the worker. Using these safe machines is the best way to prevent accidents.

After purchasing machines, it is usually difficult to make them safer as production continues. Often additional guards or enclosing the dangerous parts can help, but it is better to purchase machines in which all these necessary guards are already in place.

RISKS / SYMPTOMS

- serious injury or accident
- hand/finger injury
- wrong operation

HOW

1. When purchasing a machine, study the options carefully and order one in which all moving parts are guarded and points of manual operation are free from danger.
2. Confirm whether rotating shafts, wheels, rollers, pulleys and gears, as well as reciprocating motions, are adequately guarded.
3. Check whether feeding and ejection can be done safely without the hands coming into a dangerous point while the machine is in motion.
4. Also check whether maintenance of the machine can be done safely. In particular, the motion of the machines should be locked while they are repaired or while the maintenance work is performed.
5. Make the manual for proper operation of the machine available to all the workers concerned and provide training. Make sure that operating

instructions and labels are in the language easily understood by the workers. Keep in mind that some workers may not read well or at all; provision of training is essential.

6. You may be offered a machine without guards or unsafe versions at a lower price. Such machines can cause you many problems and cost you more in the long run. Save yourself a lot of trouble and expense by choosing the right machines.

SOME MORE HINTS

- Automatic or mechanical feeding and ejection devices can eliminate risks while greatly increasing productivity.
- Interlock guards are preferable because electrical or mechanical cycling of the machine is automatically interrupted if the guard or cover is opened or removed for operation or maintenance.

POINTS TO REMEMBER

Working in fear of accidents greatly hampers good work results. Install safe machines that cannot harm workers. Safe machines are productive and reduce injuries.

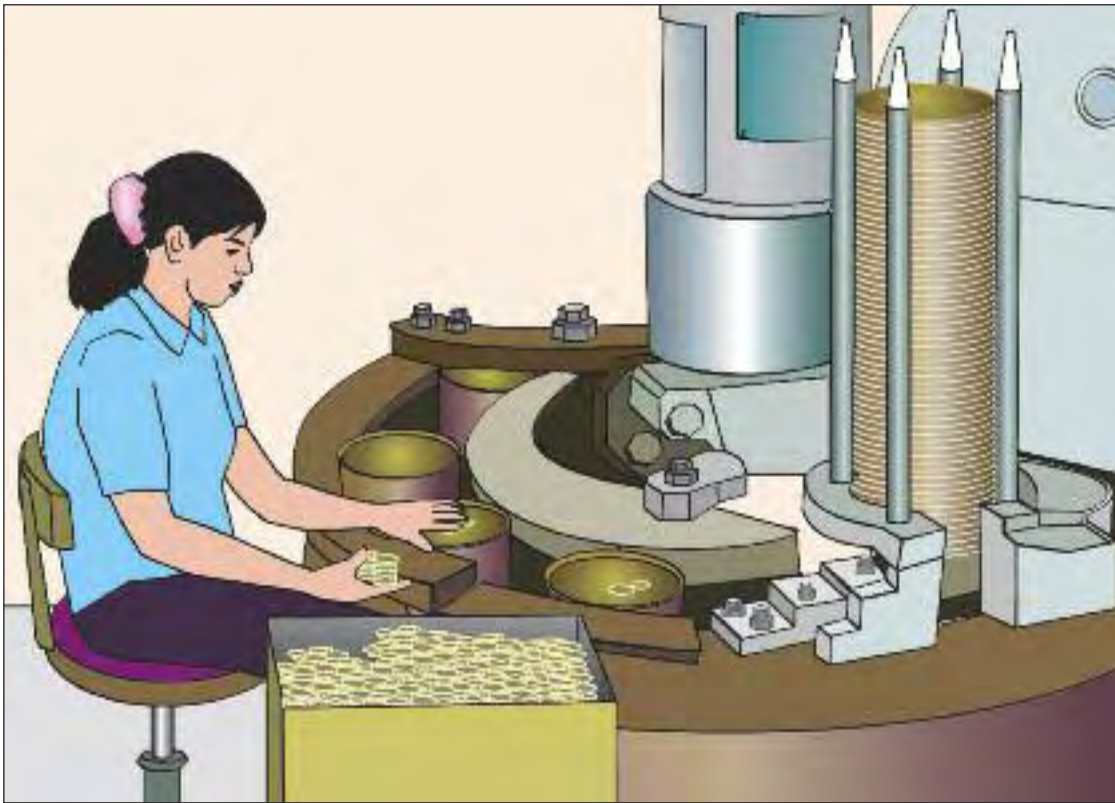

Figure 45a. Purchase machines that can avoid manual operations in danger areas as much as possible.

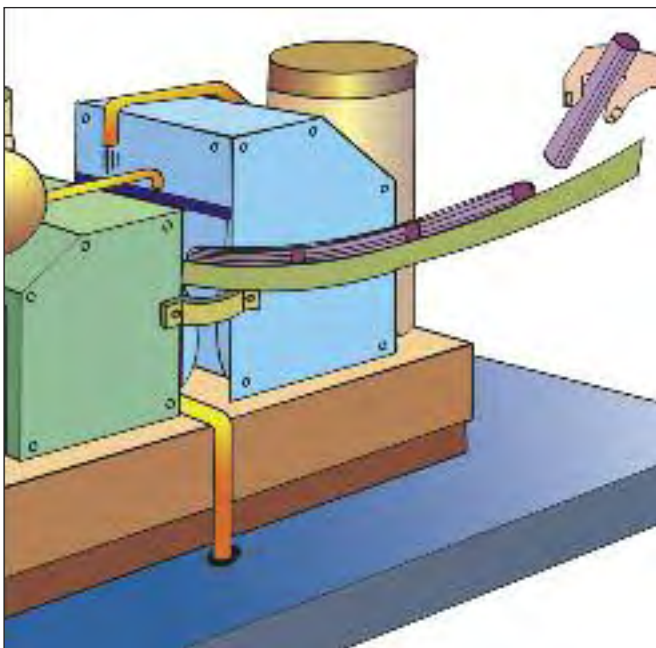

Figure 45b. A machine with a self-feeding device keeps workers' hands away from dangerous parts of the machinery.



Figure 45c. Semi-solid or granular materials can be moved with pressurized air.

CHECKPOINT 46

Use feeding and ejection devices to keep the hands away from dangerous parts of machinery.

WHY

With feeding and ejection devices, objects can be handled with greater precision and without risk of injury.

Feeding and ejection devices can greatly reduce the time for feeding and unloading. Using the time saved, the worker can carry out other tasks, such as preparing for the next work item. This means less idle time for the machine.

The use of feeding and ejection devices makes it possible to remove wastes or toxic substances without handling them manually.

RISKS / SYMPTOMS

- serious injury or accident
- hand/finger injury
- repetitive strain

HOW

1. There are many different types of feeding/ejection device. The following are some examples of simple types:
 - a. plunger feed: a plunger with a die (a slot or nest) into which the stock is placed outside the point of operation and then pushed into the point of operation as the machine is cycled;
 - b. carousel feed: a carousel type of feeder is one in which the stock is placed outside the point of operation and put under the point of operation one item at a time, combined with automatic ejection and collection of finished stock;
 - c. gravity chute feed: automatic placing of the stock in the point of operation or in the plunger device, thus saving the worker from having to place new stock at each cycle.
2. Use compressed air for feeding semi-solid or granular materials.

3. Use an ejection device that is part of the feeding system. This saves ejection time. When a separate ejection device is needed, use a mechanical device or compressed air.
4. Use feeding aids, such as hooks, bars or other extensions, to feed or remove objects. In each individual case an appropriate solution must be developed. For example, use a hook with a rounded handle to remove cutter shavings from a turning lathe.

SOME MORE HINTS

- There are many other ways to benefit from “free” gravity. In some cases, a simple inclined chute feeder can be used to move the stock into the point of operation.
- The feeding and ejection devices must not interfere with existing guards or other safety devices.
- The maintenance of feeding and ejection devices or removal of an operation failure must not cause an inadvertent cycling of the machine.
- The correct height and the placement of the feeding devices make work easier and more efficient.

POINTS TO REMEMBER

Use feeding and ejection devices to increase productivity and reduce machine hazards.

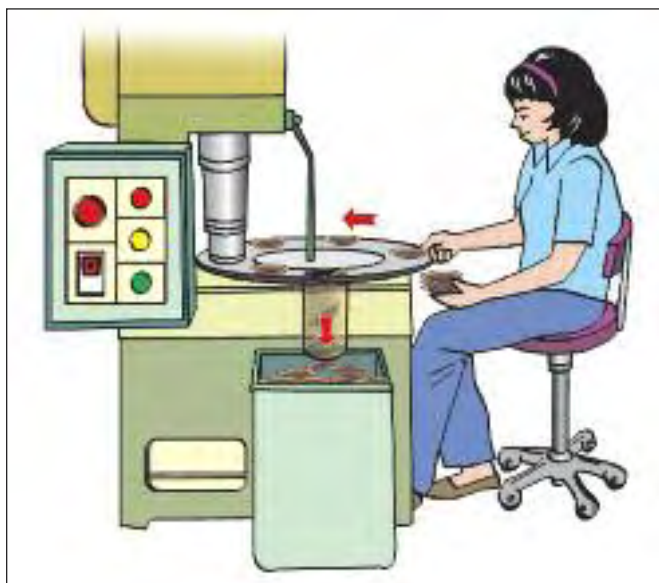

Figure 46a. Power press with carousel feed.

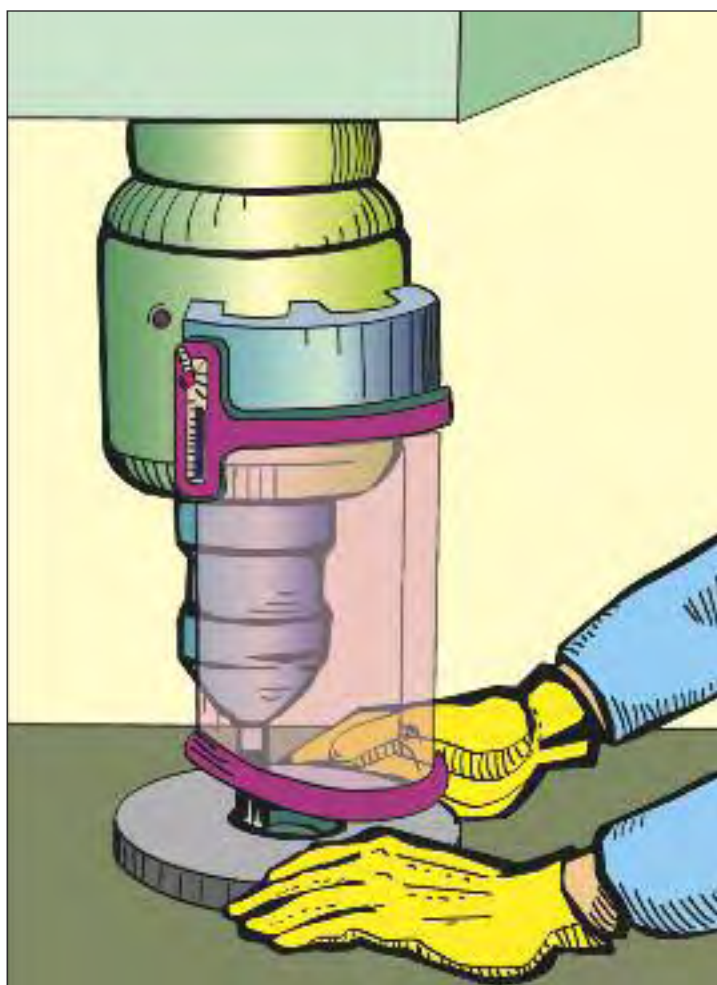

Figure 46b. A well-designed machine guard should prevent contact with moving parts of the machine and should allow the worker to do his or her job comfortably.

CHECKPOINT 47

Use properly fixed guards or barriers to prevent contact with moving parts of machines.

WHY

When working near moving parts of a machine, workers are at risk. Injuries may occur from the power transmission parts (such as gears, shafts, wheels, pulleys, rollers, belts or hydraulic lines), from the point of operation, or from flying objects such as chips, sparks or hot metal. The best protection against the risk is by preventing contact through mechanical means, not by instructing workers to avoid it.

Accidents may happen during normal operation or during cleaning and maintenance. Often bystanders and other workers can be at risk, since they do not understand how the machine operates or what precautions are necessary. Observe the national standards that prescribe the use of machine guards and barriers, and improve on these further to protect people.

RISKS / SYMPTOMS

- serious injury or accident
- hand/finger injury
- eye injury

HOW

1. Design a fixed guard that can be attached to the machine for protection against both the machine itself and flying objects. The guards must be practical to use. They must meet the requirements of the machine and the specific danger.
2. If the machine guard hinders manual operation, or if workers cannot see the task clearly, they will most likely remove the guard. Redesign these guards, or replace them with adjustable guards that can be adjusted to suit the size of work items being introduced into the point of operation and still provide a high degree of protection.
3. To make it possible to see the task clearly, use machine guards made of plastic or see-through material.

4. Put up fixed barriers in places where contact with moving parts of the machine is possible, even though this danger is not readily visible. Make sure that these barriers are stable and high enough for the purpose.
5. Where one moving part comes into contact with another and thus makes up a "pinch point", put up fixed barriers or appropriate guards to prevent fingers or hands from being caught.
6. Similarly, when two rotating rollers roll together and thus make up a "nip point", erect appropriate guards to prevent hands or clothing from being caught.

SOME MORE HINTS

- Guards may be attached directly to the machine or to a stable surface such as a wall or a floor. They should be made of strong material and provide protection against flying fragments.
- Fixed guards should be removable only by using tools.
- Fixed guards at the point of operation should be accompanied by appropriate feeding and ejection devices so as to facilitate safe operation and increase efficiency. Special hand tools may also be used to reach into the point of operation and manipulate work items (e.g. pliers and tongs with vacuum suction devices or magnetic lifters at the end).
- Manufacturers of machines usually supply machine guards. Sometimes these are impractical and you may find that it is necessary to design your own guards.

POINTS TO REMEMBER

Machine guards and barriers are important to protect workers and bystanders. If you find that they are not used, immediately seek an adequate solution by erecting a redesigned guard.

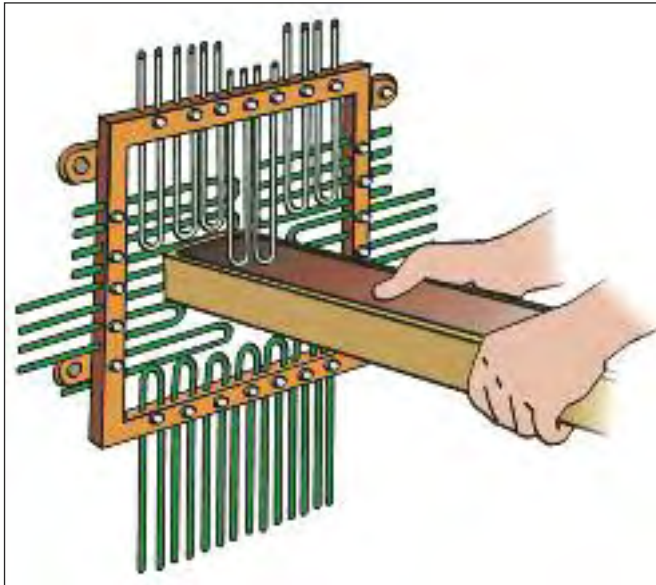

Figure 47a. A power press with plunger feed.

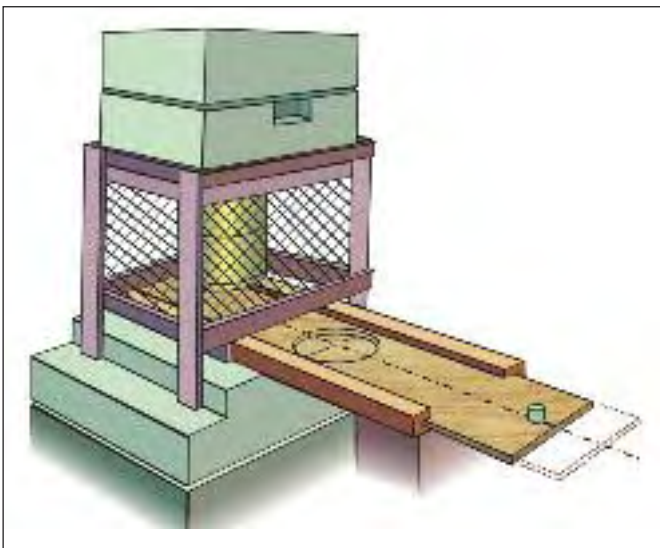

Figure 47b. An adjustable guard on a power press.

CHECKPOINT 48

Use interlock barriers to make it impossible for workers to reach dangerous points when the machine is in operation.

WHY

Accidents quite often happen when the worker opens or removes the guard or cover. If the machine stops when the guard or cover is opened or removed, there is no danger.

Interlock guards or barriers automatically interrupt the electrical or mechanical cycling of the machine as soon as the guard or cover is opened or removed.

Interlock systems may also block access to the point of operation just prior to the work cycle.

RISKS / SYMPTOMS

- serious injury or accident
- hand/finger injury
- eye injury

HOW

1. Construct a fence with a gate to enclose the process. An interlock barrier typically requires a key to open the gate. When the gate opens, an automatic switch turns off the power supply to the machine. The interlock gate needs to be closed before the dangerous machine starts moving again.
2. Where mechanical interlocking is difficult to apply, use photosensitive interlock systems. They interrupt the machine operation whenever any part of the body is beyond "light barriers" that have light sources on one side and light-receiving parts on the other.
3. Great care must be taken when a process continues in its cycle, to see that it takes more time to open the gate than the process takes to stop.
4. If interlocking is not possible, two-hand controls can be used. Two-hand controls require that two switches or levers must both be operated at the same time with both hands. In this way, the worker's hands are always outside the machine while it operates.

SOME MORE HINTS

- Because interlocks or two-hand controls may be inconvenient for the production process, they are sometimes tampered with. The interlocks and their switches should be designed so that they are tamperproof and cannot be easily broken or overridden with screwdrivers, pencils or adhesive tape. Two-hand controls should be designed so that the two switches cannot be operated with one hand, taped or jammed on, pressed with the knee or otherwise circumvented.
- A large space behind the interlocking barrier can cause a serious hazard, because it is possible to close the gate behind a worker inside the danger area. Somebody else, being unaware of the presence of the worker inside, may close the gate and thus activate the machine. The key should therefore be used both for closing and opening, and the worker should be told to put the key in his or her pocket so that no one else can use it while inside the danger area.
- Interlocks are also common on electrical equipment. The process equipment may be enclosed in a box with an opening and a key. The key opens up the box and breaks the power supply.

POINTS TO REMEMBER

An interlock is an effective means to protect workers from the danger area of a machine. It is used to turn off a production process automatically, making it possible for workers to reach work items for inspection or repair.

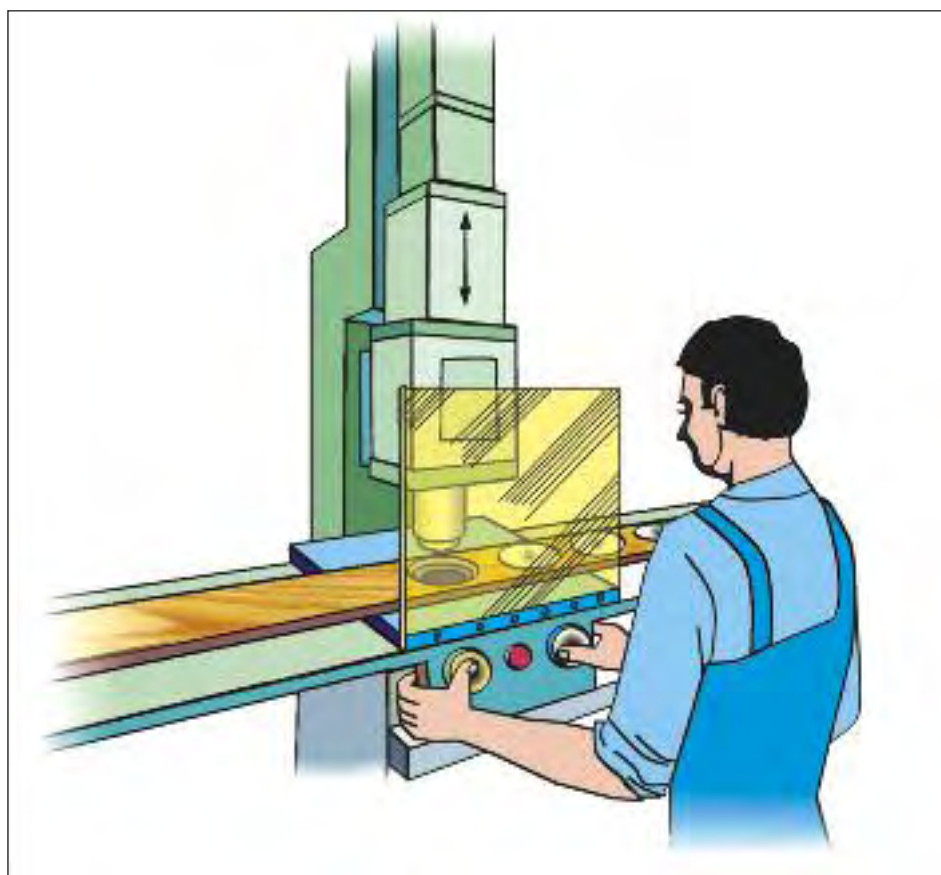

Figure 48a. A machine with two-hand controls.

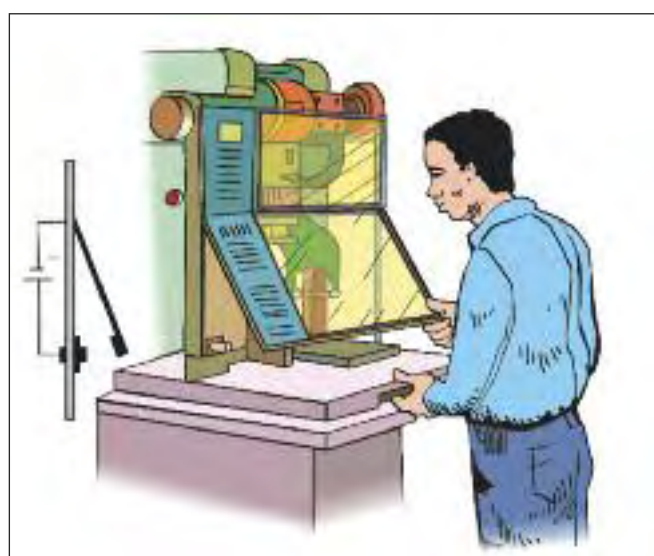

Figure 48b. An interlock guard with a shut-off device.

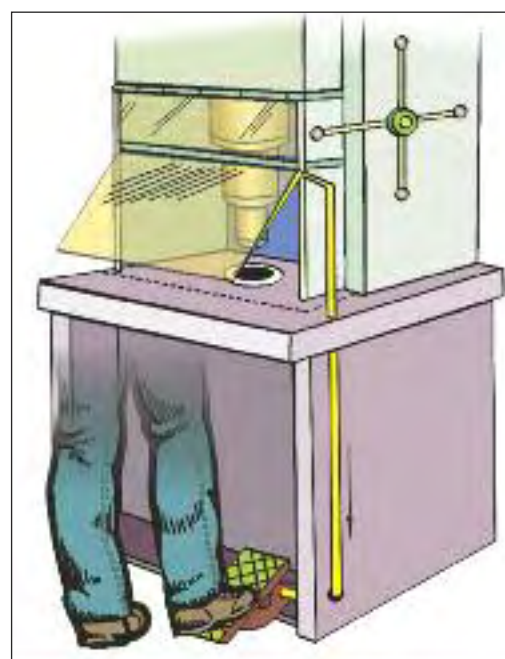

Figure 48c. Pedal activation of an interlock guard.

CHECKPOINT 49

Establish safe procedures for forklift driving by modifying the workplace and providing adequate training.

WHY

Safe driving of forklifts is important for safe and efficient materials handling, as forklifts come in contact with many people at the workplace. Most of these people are doing other tasks, and may be injured by suddenly encountering the running forklifts.

Forklift drivers perform a variety of tasks, such as loading, driving, unloading and assisting workstation operators. It is sometimes difficult to see the roadway over the loads. Support for easier forklift driving can greatly enhance workplace safety.

Unnatural postures often occur for forklift drivers during travelling in reverse and over uneven ground. Twisted postures and whole body vibration may increase the potential for musculoskeletal disorders. Appropriate driving practices can reduce such risks.

When the work area is restricted in space, forklifts may run into structures such as racking and doorways, and may even harm pedestrians. Keeping roadways cleared and establishing smooth travel procedures can reduce these risks.

RISKS / SYMPTOMS

- serious injury or accident
- muscular strain
- low back pain
- leg/foot injury
- whole-body vibration
- product damage

HOW

1. Maintain the roadways used by forklifts to eliminate uneven surfaces such as potholes and poorly fitting dock plates. Separate the walkways for pedestrians from the roadways used by forklifts.
2. Use a checklist to ensure the key safety features of forklifts and travel routes are operational before daily use. Make sure barriers are in place around

corners of racking or doorways. Ensure that a warning siren and a reverse light are activated in reverse travel.

3. Secure your safety belt and make sure the load is within the forklift's rated capacity.
4. Provide support for increasing the comfort of forklift driving, such as a vibration-absorbing seat, mirrors or spotters, increasing overhead clearance, selecting appropriate pallets, etc.
5. Provide training for the driver on how to operate the forklift safely. This includes proper and balanced lifting, travelling at an appropriate speed, always looking in the direction of travel, keeping the arms and legs inside, moving slowly into position, unloading keeping necessary allowances, etc.
6. If rollover bars are not fitted, retrofit the forklift with appropriate equipment.

SOME MORE HINTS

- Purchase forklifts equipped with rollover protection that can protect the driver in the event that the forklift rolls over.
- Introduce a roadway maintenance program to avoid potholes developing. Ensure the visibility of the working environment for the driver and for the pedestrians.
- Locate the truck loading area close to the storage area for the pallets to minimize the travel distance for the forklift.
- Install speed-limiting devices to forklifts used in congested areas to ensure that speed levels are controlled.

POINTS TO REMEMBER

A forklift is a large piece of machinery that moves between the inside and outside of buildings where various kinds of work are done. Clearly defined roadways and safe travel procedures are required to manage the forklift safety.



Figure 49a. Provide support to increase the comfort of forklift driving, such as a vibration-absorbing seat, mirrors, overhead structure and appropriate pallets.



Figure 49b. Use a checklist to ensure the key safety features of forklifts and travel routes are operational before daily use.

CHECKPOINT 50

Inspect, clean and maintain machines regularly, including electric wiring.

WHY

A well-maintained machine is less likely to break down. A poorly maintained machine can not only have more breakdowns but can also be dangerous.

A well-maintained machine with safe wiring is less likely to catch fire and electrocute workers.

Machine guards should also be inspected, cleaned, and repaired or replaced, as necessary.

RISKS / SYMPTOMS

- serious injury or accident
- electrocution
- wrong operation
- fire or explosion
- uncontrolled emergency
- product damage

HOW

1. Develop a schedule of routine inspection, cleaning and preventive maintenance.
2. Create an inspection and maintenance log (record book) for each machine and each work area. Make this log available to all workers.
3. Designate key personnel to be responsible for inspecting the machines and the logs.
4. Maintenance should also include seeing that all necessary machine guards are in place.
5. Train workers to perform inspections at their own work area and report deficiencies.
6. When machines are being repaired, or when maintenance tasks are being performed, the control mechanisms of the machines should be locked and should have a tag saying "DANGER! DO NOT OPERATE!"

SOME MORE HINTS

- A machine maintenance programme, carried out by qualified personnel, will reduce the frequency of repairs and reduce the need for the worker to remove guards.
- Cooperation of all workers is necessary for proper maintenance and cleaning of machines. Make it clear that the maintenance programme is an essential part of good production management.
- Reward workers for inspecting and maintaining the machines.

POINTS TO REMEMBER

Proper maintenance does not mean lost production time. It is an investment in higher productivity, enhanced safety and lower repair costs.



Figure 50a. Front and back views of a typical tag used when equipment is taken out of service because it has become unsafe.

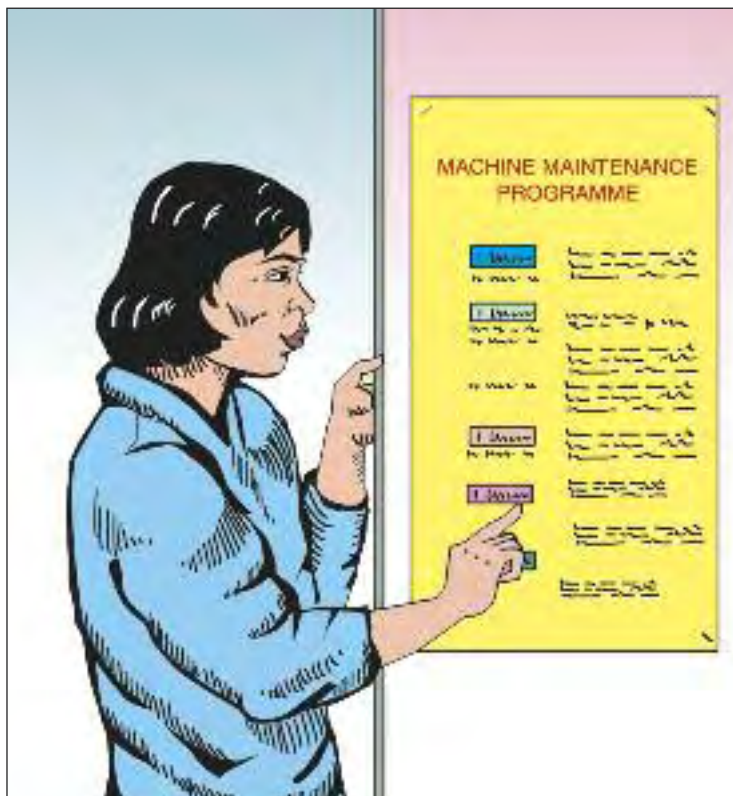

Figure 50b. Make known to all workers concerned the machine maintenance programme in operation and train them to perform their duties.

Workstation design

CHECKPOINT 51

Adjust the working height for each worker at elbow level or slightly below it.

WHY

The correct height of places where work is done with the hands facilitates efficient work and reduces fatigue. Most work operations are best performed around elbow level.

If the worksurface is too high, the neck and shoulders become stiff and painful as arms must be held high. This happens in both standing and sitting positions.

If the worksurface is too low, low back pain easily develops as the work has to be done with the body bent forward. This is serious in a standing position. In a sitting position, too low a working height causes both shoulder and back discomfort in the long run.

RISKS / SYMPTOMS

- muscular strain
- excessive reach
- excessive fatigue
- low back pain
- upper limb disorder
- wrong operation

HOW

1. For seated workers, worksurface height should be around elbow level. Working height can be slightly below elbow level if forces need to be exerted downward. If using a keyboard, the height at which the fingers operate should be at or slightly below elbow level. This is dependent on keyboarding abilities.
2. An exception should be made for high-precision work while sitting. In this case, the object can be raised slightly above elbow level to allow the worker to see the fine detail. In this case, provide armrests. A jig may also be required to support the object.
3. For standing workers, the hand height should be a little or somewhat below elbow level. For work

requiring accuracy, elbow height can be chosen. In light assembly work or packing of large items, the hand height should be about 10–15 cm lower than elbow level. When the use of very strong force is needed, an even lower height is appropriate so as to allow the use of body weight. However, too low a work height should be avoided because it can cause lower back pain.

4. Where possible, use an adjustable work table, for example a lift-table with a hydraulic device for raising or lowering the table height.
5. Use a platform or a similar flat structure under tables, worksurfaces or work items to raise the working hand height. Use platforms under the feet or chair to lower the actual working height in relation to elbow level. These adjustments are extremely effective.

SOME MORE HINTS

- Adjusting working height is much easier than people normally think. As machines or tables are involved, people tend to think that changing work height is impossible or too expensive. This is not true. Learning from the above examples, use your own ideas.
- Adjustable work tables are available. They facilitate use of the same workstation by several people, and thus increase productivity.
- If the same work table is used for both standing and sitting work, take care to provide a higher working surface for standing work and to avoid too high a working height for seated work. This is usually done by choosing a table suited to seated workers and inserting platforms or fixtures under work items handled while standing, to raise them to the correct level. Alternatively, choose a table height for standing work and provide high chairs and adjustable footrests for seated work.

POINTS TO REMEMBER

Apply the “elbow rule” to determine the correct hand height for greater efficiency and to reduce neck, shoulder and arm discomfort.

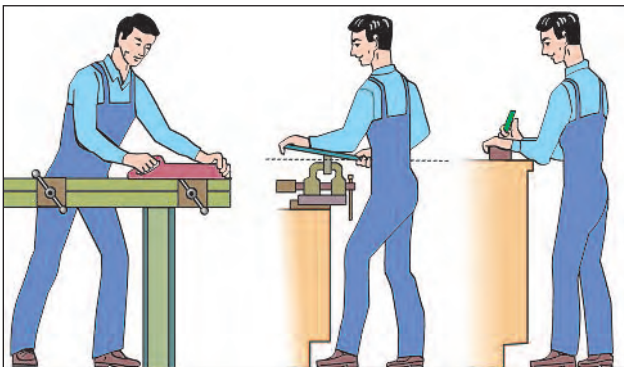

Figure 51a. Most work operations are best performed around elbow level.



Figure 51b. For seated workers, worksurface height should be around elbow level.

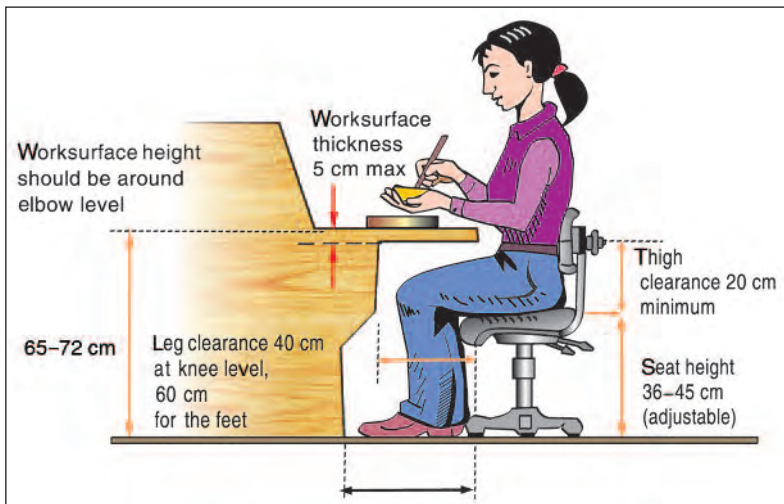

Figure 51c. Recommended dimensions for most seated tasks.

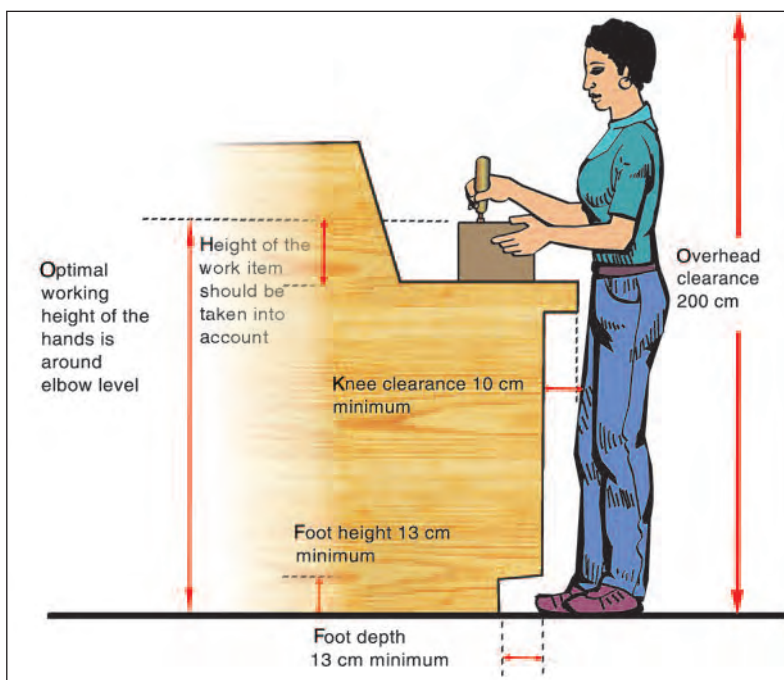

Figure 51d. Recommended dimensions for standing work.

CHECKPOINT 52

Make sure that the workplace accommodates the needs of smaller workers.

WHY

Differences in body size of workers are usually very large in any workplace. The differences are becoming even larger with time as workers of both sexes from different regions come together. Special care must be taken so that controls and materials can be reached easily by all workers.

Controls and materials that are too remotely placed fatigue smaller workers and reduce their efficiency. This is dangerous and must be avoided.

RISKS / SYMPTOMS

- excessive reach
- muscular strain
- low back pain
- upper limb disorder

HOW

1. Purchase machines and equipment with adjustable worksurface height. Then adjust the height to suit smaller workers.
2. Replace controls (although this might be relatively difficult once machines are bought) and materials so that they are within easy reach of smaller workers. If the same controls and materials are dealt with by taller workers, make sure that they are still within easy reach of taller workers.
3. Use platforms for smaller workers so that the hand position of these workers becomes higher and can easily reach controls and materials. Ensure that the stand does not present a tripping and falling hazard.
4. Use a foot-stand or a mobile platform to enable workers to reach particular controls or materials which are difficult for them to reach.

SOME MORE HINTS

- Ask smaller workers whether they have difficulties in reaching controls and materials. Discuss with them how this can be improved. There are usually practical ways to solve the problem.
- For a lever control, an extension can make it easy for smaller workers to operate it. Consider similar arrangements to improve the difficult reach of some controls.
- A mobile control panel or keyboard can make the workstation easily adjustable for both larger and smaller workers.

POINTS TO REMEMBER

Make sure that smaller workers can comfortably reach controls and materials.

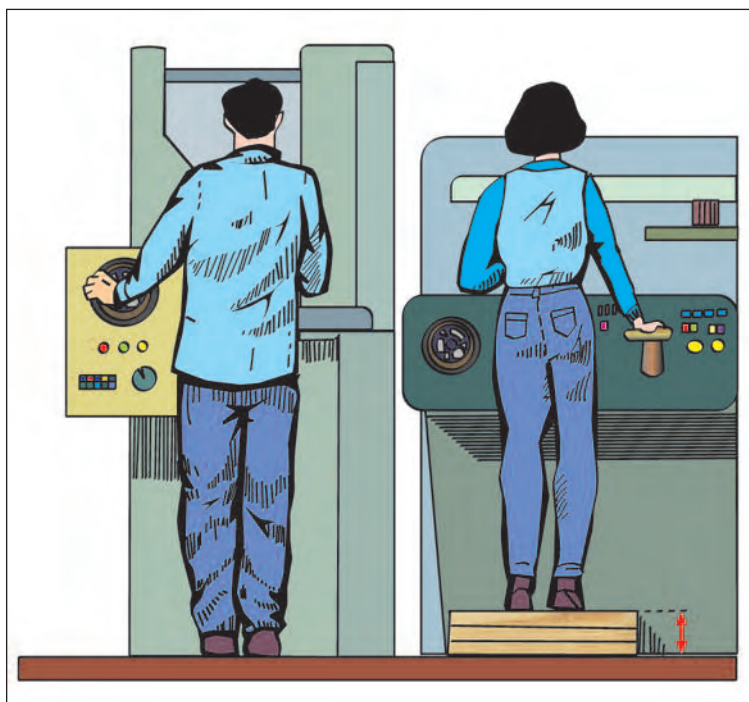

Figure 52a. Use a foot platform for smaller workers to ensure an appropriate work height at around elbow level.



Figure 52b. Avoid a situation where controls or machinery are difficult to reach.

CHECKPOINT 53

Make sure that the workplace accommodates the needs of taller workers.

WHY

Generally, adjustment of worksurface height for larger people is relatively easy. However, clearance for movement or clearance under the work table is difficult to expand once the workstation is installed. Clearance must be large enough from the outset to accommodate larger people.

In order to accommodate larger people, it is most important to provide adequate leg and knee clearance. Extra space is also necessary to accommodate taller people.

Enough space to move the legs and body easily will reduce fatigue and the risk of musculoskeletal disorders, thus improving the worker's efficiency.

RISKS / SYMPTOMS

- muscular strain
- upper limb disorder
- low back pain

HOW

1. Check overall space clearance of all workstations and passageways for the largest worker, and increase clearance where necessary.
2. Check knee and leg clearance of workstations used by the largest worker. If knee and leg clearance is too narrow, consider how the clearance can be expanded. Raise the work-table height or expand the work-table size, for example.
3. Mark all unsafe clearances with bright colours and warning signs.

SOME MORE HINTS

- Ask the largest worker where he or she feels unsafe or whether the space is too narrow. Take measures to deal first with unsafe conditions, and then with discomfort.

- It is uneconomical and impractical to design equipment for people of all sizes. Often equipment is designed to accommodate about 90 per cent of the proposed user population, which means that the smallest and largest 5 per cent may be excluded. In your workplace, therefore, make sure that even the largest and smallest workers feel safe and comfortable with the existing space. Just following regulations might not be enough.
- Also consider the other body-size related needs faced by larger workers: gloves, protective clothing, helmets, etc.

POINTS TO REMEMBER

Make sure that the largest workers feel comfortable and safe with the existing space.

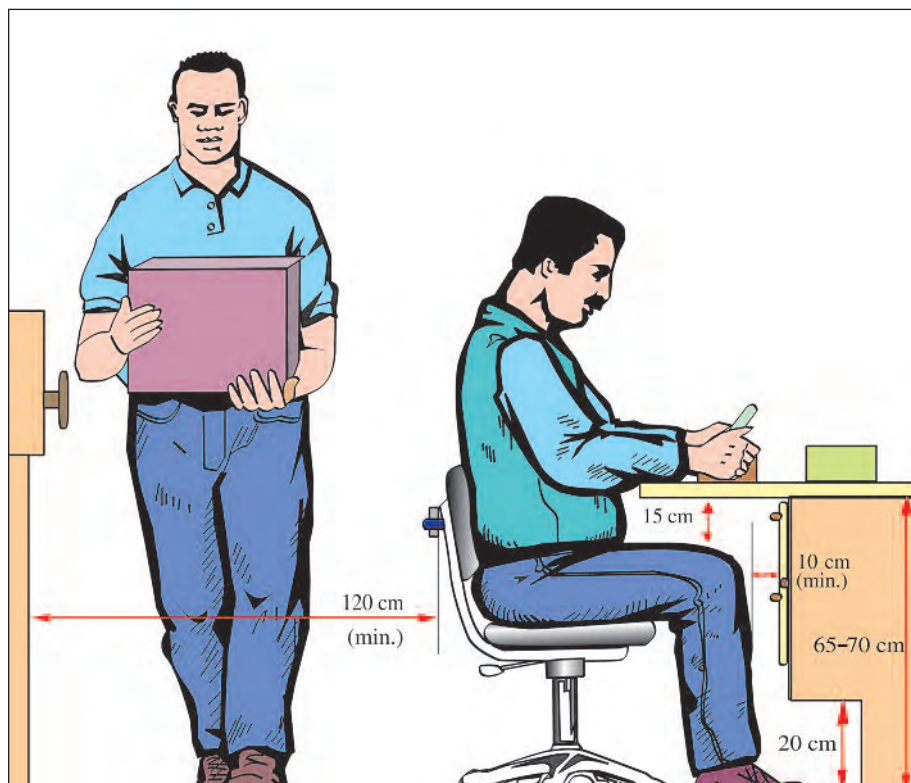

Figure 53. Ensure there is enough space for larger workers in aisles and at workstations. Remember to provide sufficient knee and leg clearance.

CHECKPOINT 54

Place frequently used materials, tools and controls within easy reach.

WHY

Time and energy are saved by placing materials, tools and controls within easy reach of the workers.

Long reaches mean a loss of production time and extra effort.

The distance that can be reached easily without bending forward or stretching is quite small. Long reaches can thus lead to neck, shoulder and back pain, as well as to imprecise operations.

RISKS / SYMPTOMS

- excessive reach
- repetitive strain
- low back pain

HOW

1. Place frequently used tools and controls within the primary hand movement area. This is between 15 and 40 cm from the front of the body and within 40 cm from the side of the body at elbow height.
2. Place all frequently used materials within this primary hand movement area or at the margin of this area. When materials are supplied in boxes or bins, or on pallets or racks, they should be placed within easy reach and at around elbow height.
3. For similar workstations, organize the placing of tools, controls, materials and other work items in a good combination with each other. For example, when several kinds of material are collected at the same time or one after another, place them in the same area in different bins. Standardize the location of all these items based on the opinions of the workers.
4. If appropriate, divide the work-table surface into subtask areas so that different operations are done sequentially.

SOME MORE HINTS

- It is very important to place within this primary hand movement area all the items used regularly. Let workers adjust the workstation to their needs.
- Displays and instructions can be placed beyond this easy-reach area as long as they are presented in an easy-to-read form.
- Materials, tools and controls can be placed not only on the main work table but also on a side table or a rack placed within easy reach. Less frequently used items can be placed at the side of the worker.
- Tools or materials used only occasionally (a few times per hour, for example) may be placed at a distance reached by leaning forward or stretching aside, or even outside the immediate work area, without much loss in productivity.
- Provide adjustment for left-handed workers.

POINTS TO REMEMBER

Place frequently used materials, tools and controls within easy reach. This easy-reach area is quite narrow, and you can determine it by trying to reach while keeping your natural posture.

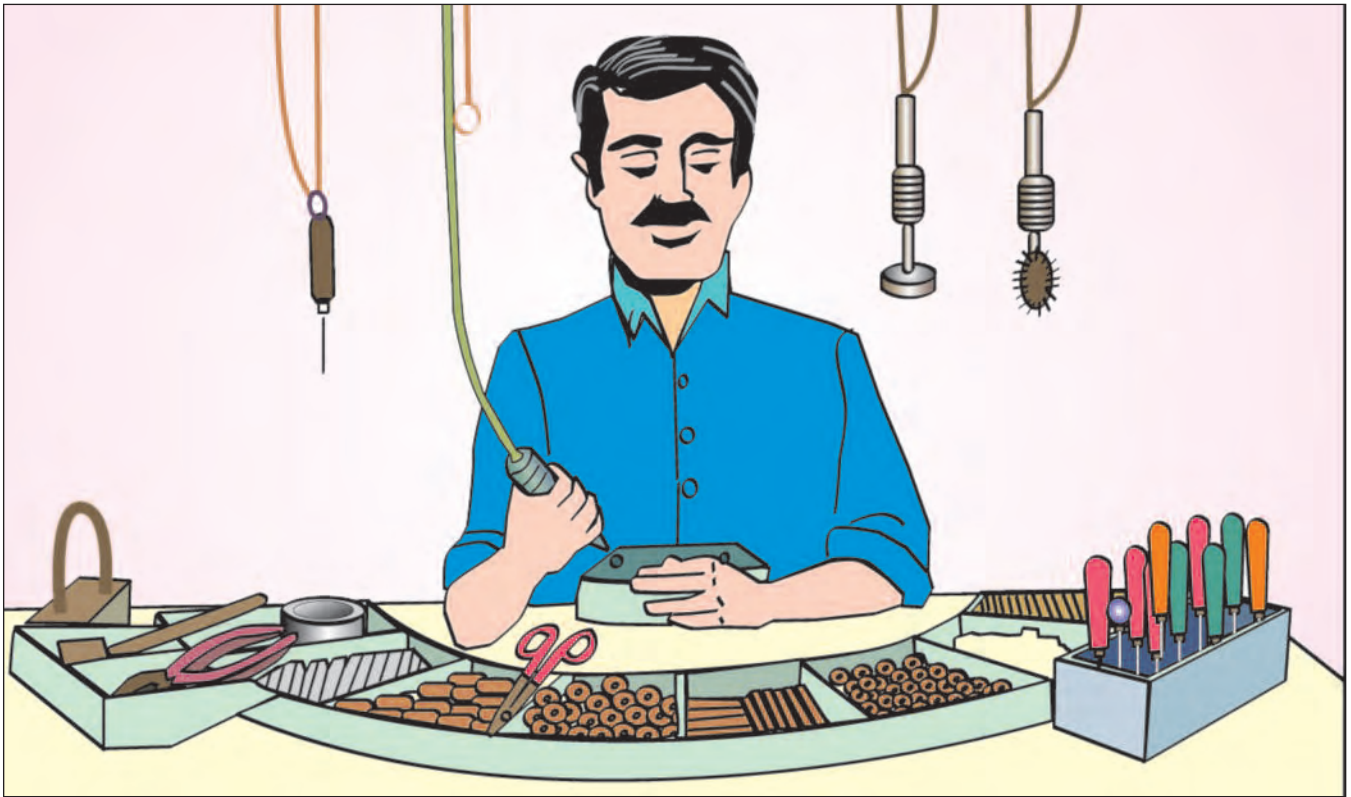

Figure 54. Place frequently used materials, tools and controls within easy reach.

CHECKPOINT 55

Provide a stable multi-purpose worksurface at each workstation.

WHY

Work at any workstation consists of a variety of tasks including preparation, main operations, recording, communication and maintenance. A stable worksurface of a certain size is needed to accommodate not only principal tasks but also various other tasks.

A worksurface that is too narrow or unsteady results in time loss and more effort, thus reducing work efficiency and increasing fatigue.

RISKS / SYMPTOMS

- muscular strain
- upper limb disorder
- excessive reach

HOW

1. At each workstation provide a stable worksurface of appropriate size where a variety of tasks can be done, including preparation, main tasks, recording, communication and maintenance-related tasks. Such a surface is usually available when the work requires a work table, but tends to be neglected when the main operations do not require a table.
2. Avoid a makeshift worksurface or an unsteady surface. Work done on it becomes frustrating and of low quality.
3. The thickness of the worksurface should be not more than 5 cm. This is necessary to secure knee space underneath. Therefore avoid putting drawers or under-table shelves in front of the seated worker where the legs are positioned.
4. In the case of a visual display unit (VDU) workstation, a worksurface is needed, in addition to the keyboard space, for preparation, document holding, writing and maintenance.

SOME MORE HINTS

- Consider the whole working day at the workstation. Pay due attention to all the necessary preparatory and subsidiary tasks. A worksurface of a certain size is often useful even if the main tasks do not necessitate it.
- Also consider places for small tools, stationery and other personal items.
- If appropriate, use a side table, an existing flat surface on a rack or nearby workstands.

POINTS TO REMEMBER

Provide a stable worksurface at each workstation for use for a variety of preparatory, main and subsidiary tasks.



Figure 55. Provide a stable multi-purpose worksurface at each workstation.

CHECKPOINT 56

Make sure that workers can stand naturally, with weight on both feet, and perform work close to and in front of the body.

WHY

Working operations are more stable and efficient when done close to and in front of the body in a natural posture. The workstation should be designed to allow for such operations.

Working in an unstable position might cause a costly mistake.

Fatigue of workers and the risk of neck, shoulder, arm and back disorders are reduced when the work is done avoiding unnatural postures.

RISKS / SYMPTOMS

- low back pain
- excessive reach
- repetitive strain
- upper limb disorder

HOW

1. Arrange all important and frequent operations so that they are carried out close to and in front of the body, and around or slightly below elbow level. Make sure that the work table or working height close to and in front of the body is free from obstacles.
2. Make sure that these frequent operations can be performed without raising the elbow high or bending or twisting the body long enough to cause discomfort.
3. Provide adjustable workstations when used by different workers or where different tasks are carried out. If adjustable workstations are impractical, provide platforms or other means to adjust the working height to each worker. Use lifting and tilting arrangements if needed.

SOME MORE HINTS

- There are two easy ways to find out about unnatural postures. First, ask the workers whether they feel pain or discomfort during work. Second, watch the work operations and find those done by stretching, bending or twisting the body.
- The optimal heights for frequent work operations are: for standing work between waist level and heart level; for sitting work between elbow level and heart level.
- Workers get tired if work operations are always done at the same place, even at the optimal place. Variations in work posture are essential. Therefore avoid repetitive tasks that need to be done in the same posture all the time.

POINTS TO REMEMBER

When work is done in a natural posture, with weight on both feet and without bending or twisting, fatigue is less and productivity is higher. Arrange for good hand positions allowing this posture.

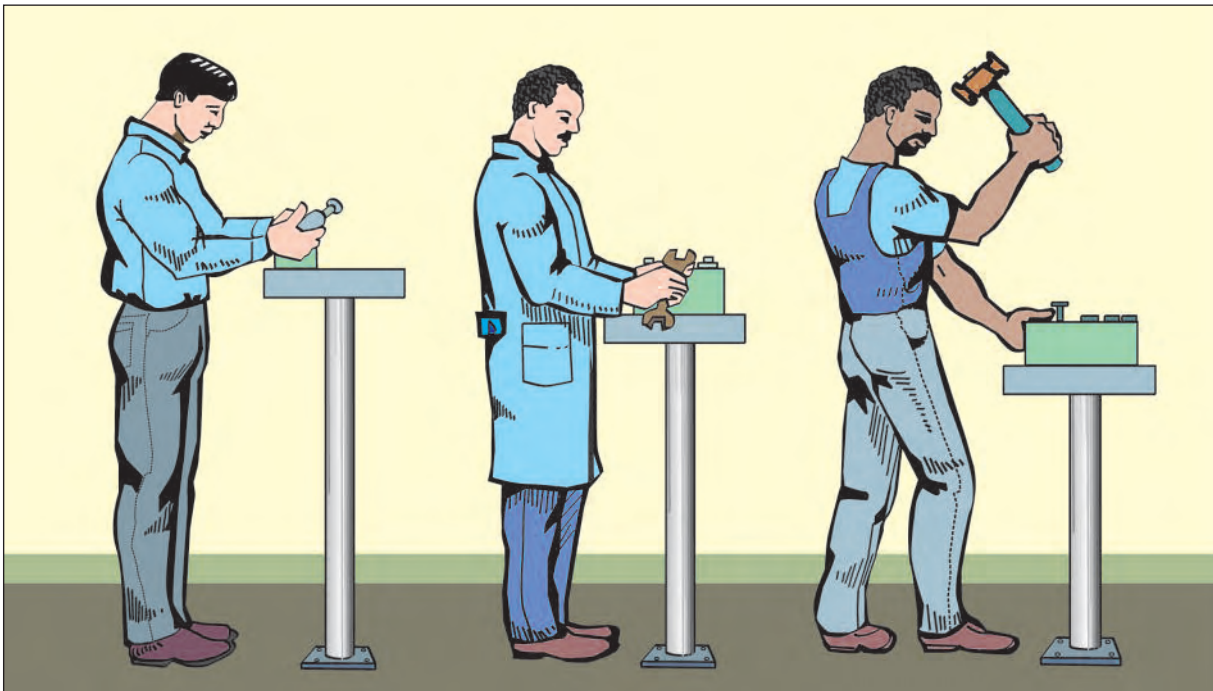

Figure 56a. Provide a standing workstation for a job requiring a lot of body movement and greater force.

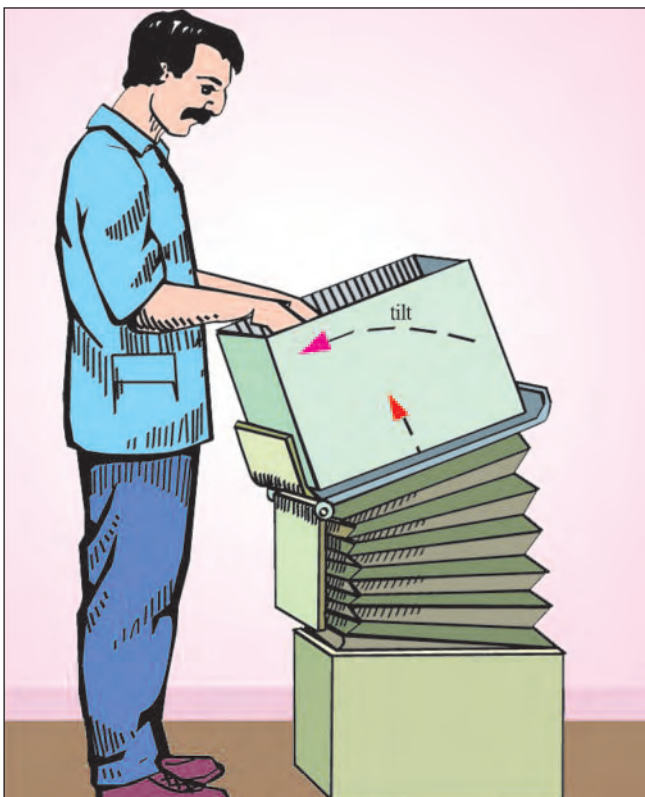

Figure 56b. Doing work in front of the body at elbow height or at a level a little below is always desirable. Use lifting and tilting arrangements if needed.

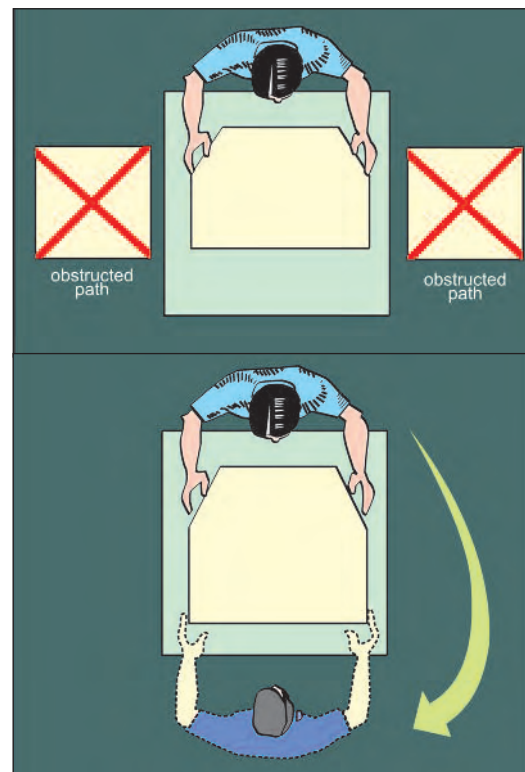

Figure 56c. Doing work in front of the body at elbow height or at a level a little below is always desirable. Use lifting and tilting arrangements if needed.

CHECKPOINT 57

Allow workers to alternate standing and sitting at work as much as possible.

WHY

Alternating standing and sitting is much better than keeping either posture for a long period of time. It is less stressful, reduces fatigue and improves morale.

Alternating standing and sitting may mean combining different tasks, thus facilitating communication and the acquisition of multiple skills.

Strictly machine-paced work requires keeping the same posture. This is tiring and tends to increase mistakes. By providing chances for occasional sitting or standing, the work becomes better organized.

RISKS / SYMPTOMS

- repetitive strain
- monotony
- upper limb disorder
- low back pain
- excessive fatigue
- lack of acceptance

HOW

1. Provide sitting workplaces for workers performing tasks requiring precision or detailed inspection of work items, and standing workplaces for workers performing tasks requiring body movements and greater force.
2. Assign work tasks so that the worker can do these different tasks by alternating standing and sitting while at work. For example, preparation while standing and sitting, power tool work while standing, inspection and recording while sitting.
3. If the main tasks are done at standing workstations, then allow for occasional sitting (e.g. for watch keeping, recording or at the end of a series of work tasks).
4. If the main tasks are done in a sitting posture, then opportunities should be provided for occasional standing, e.g. for collecting materials from storage,

communicating with other workers or monitoring work results, or after completing one or a few work cycles.

5. If appropriate, organize job rotation so that the same worker can go through different jobs alternating standing and sitting.
6. If alternating standing and sitting at work is not at all possible, insert short breaks to allow for the change.

SOME MORE HINTS

- If it seems difficult to introduce the new routine of alternating standing and sitting, just try to see if such changes are possible by providing standing workers with chairs for occasional sitting and by providing sitting workers with an additional space where some secondary tasks can be done while standing. This trial may facilitate a new routine.
- Multiple skills are increasingly important for various kinds of work. In arranging multi-skilled work to be done by a group of workers, it is possible to combine standing and sitting tasks for each individual worker.

POINTS TO REMEMBER

Assign work tasks in order to create opportunities to alternate standing and sitting for greater efficiency and comfort.

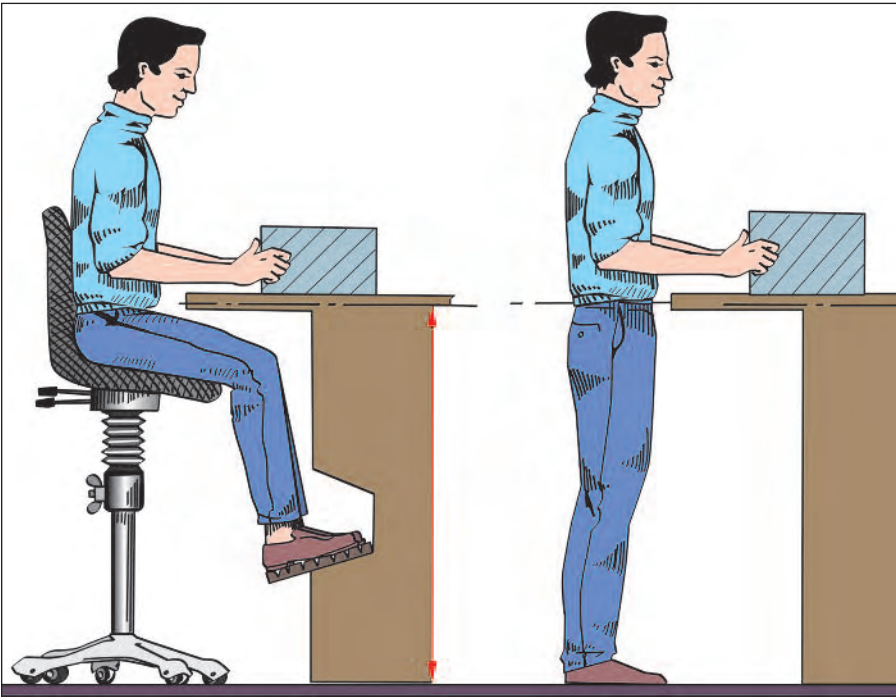

Figure 57a. For alternating standing and sitting postures when doing the same or similar tasks at a work table, a high stool with a good footrest is useful. Make sure that there is enough leg room in either posture.

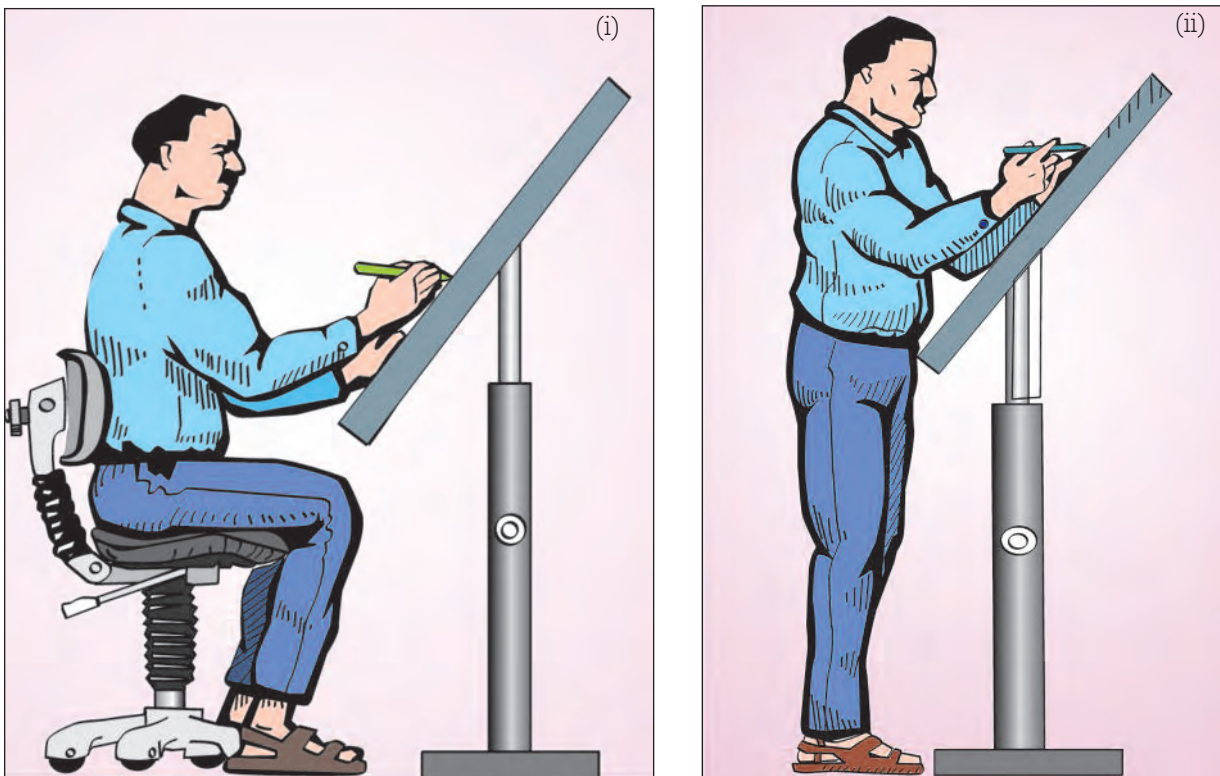

Figure 57b. (i) and (ii) Allow workers to alternate standing and sitting at work as much as possible.

CHECKPOINT 58

Provide standing workers with chairs or stools for occasional sitting.

WHY

Standing all the time is very tiring. It increases pain in the back, legs and feet, and affects work quality. Occasional sitting helps to reduce fatigue.

Standing all the time is often considered a matter of discipline. But most standing workers do have the chance to sit and should be allowed to do so through the provision of chairs or stools. This helps to increase work quality and job satisfaction.

If some of the tasks carried out by standing workers can be done sitting, arrange for this to be done. Alternating sitting and standing is a good way of organizing work.

RISKS / SYMPTOMS

- low back pain
- muscular strain
- repetitive strain

HOW

1. Provide a chair or stool near each standing worker. If there is no immediate space for this purpose near the workstation, put chairs or stools or a bench near a group of workers.
2. See if workers are using makeshift chairs for occasional sitting. Formally allow workers to use chairs when they need it.
3. Check if part of the tasks assigned to the standing worker can be done while sitting (e.g. some preparatory tasks or keeping watch over the machine operation). Arrange for occasional sitting work, where possible.

SOME MORE HINTS

- Various inexpensive chairs can be used for occasional sitting. Support stools for easy occasional sitting can likewise be helpful. It may be

useful if these chairs or stools do not occupy too much space and do not disturb the work.

- Make sure that the place for occasional sitting is accessible and safe.

POINTS TO REMEMBER

Occasional sitting is a good principle for standing work. Encourage it, and provide chairs or stools near the workstation.



Figure 58a. Use a variety of means to ensure the comfort of a standing worker.

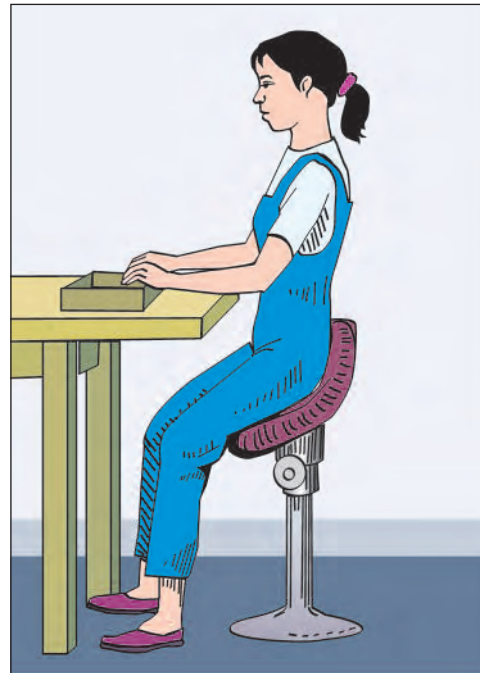

Figure 58b. Provide standing workers with chairs or stools so that they may sit occasionally.

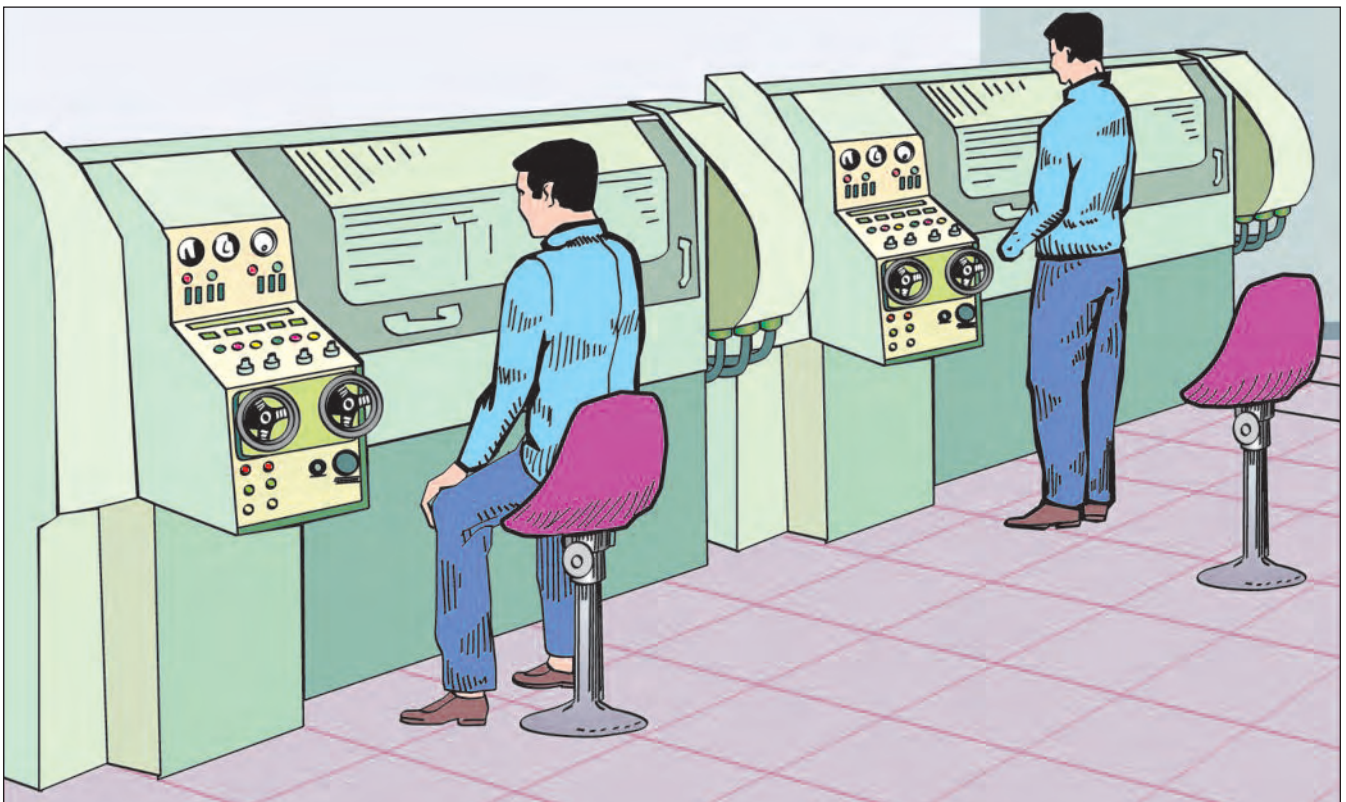

Figure 58c. At a workstation for standing work, a high chair for occasional sitting while keeping watch can be useful.

CHECKPOINT 59

Provide sitting workers with good adjustable chairs with a backrest.

WHY

Seated work seems comfortable compared with other forms of work. However, sitting for long hours is also tiring. Good chairs reduce fatigue, improve work efficiency and increase job satisfaction.

Often it is not considered worthwhile investing money in chairs. But consider that a chair can last for years, and that the cost per day is only a very small fraction of the labour cost (an estimate is 0.1 per cent or even as low as 0.01 per cent). A good chair that improves productivity and job satisfaction more than offsets this minimal cost.

RISKS / SYMPTOMS

- low back pain
- upper limb disorder
- muscular strain
- excessive fatigue

HOW

1. A suitable seat height is the height at which the worker can sit with the feet placed flat and comfortably on the floor and without any pressure to the back of the lower thigh. Provide a chair with adjustable height. Height adjustment should be very easy while sitting on the chair.
2. If an adjustable chair is not feasible, each worker should use a chair of correct height, or alternatively use a footrest or seat cushion in order to attain the correct floor/seat height difference.
3. Use a padded backrest that supports the lowest part of the back (often called the lumbar area) at waist level (about 15–20 cm above the seat surface) as people will lean both forward and backward in the chair. The backrest should also support the upper back for occasional leaning backward.
4. Provide a good seat surface with some padding, neither too hard nor too soft, so that the worker can easily change the sitting posture in the chair.

5. Ensure good mobility required for the work and for occasional changes of the sitting posture while in the chair. Five-leg chairs with castors are good for many seated tasks.

SOME MORE HINTS

- Ensure a good combination of correct seat height (lower end of kneecap level) and correct working height (elbow level). It is wrong to use a seat higher than the correct height in order to make the elbow level reach a high work table, because a high chair oppresses the thighs and restricts leg movements; this is very tiring for the worker.
- Do not use armrests for work that requires a lot of arm movements, as they inhibit mobility. Armrests are sometimes useful to give support for the whole arm. In this case, supporting the whole arm is better than just supporting the wrist.
- After adjusting the seat height so that the work is slightly below the elbow, the feet may dangle. This happens when the working height is not adjustable. In this case, use a footrest.

POINTS TO REMEMBER

Provide “ergonomic chairs” adjustable to each worker for correct seat height and with a good backrest. The chair should allow good mobility in the chair. Do not forget to instruct all workers how to adjust their chairs.



Figure 59a. Provide sitting workers with good adjustable chairs with a backrest.

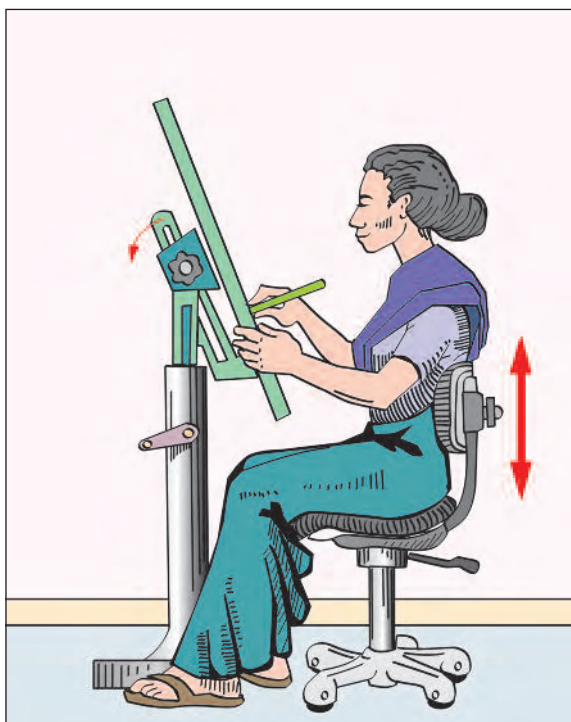

Figure 59b. Provide an adjustable sitting workstation for a job requiring high accuracy.

CHECKPOINT 60

Use height-adjusted computer workstations, and arrange related computer peripherals within easy reach.

WHY

Adjusting the height of the workstation to preferred positions of displays and controls can reduce visual, neck, shoulder and back strains.

If the display screen, keyboard and chair height can be easily adjusted, both large and small workers can use the same workstation comfortably.

The prolonged use of a laptop computer on a standard desk can be straining to the neck, hands, wrists and shoulders. This is because laptops have smaller and lower displays, smaller keyboards and track pads. Adjustable workstations can avoid these strains.

Computer peripherals that are well arranged within the reach of the worker can reduce unnecessary over-reaching motions and secure adequate lighting while reducing screen glare.

Well-adjusted computer workstations can help workers organize their work at their own pace. Workers can thus insert micro-pauses that help them recover from fatigue and work.

RISKS / SYMPTOMS

- upper limb disorder
- eye strain
- repetitive strain
- muscular strain
- stress-induced disorder

HOW

1. Use height-adjustable furniture including a table, a chair, and a computer monitor. The table must be adjustable to fit a range of short to tall workers (in most cases 56–72 cm). The chair must have adjustable seat height and backrest angle. The computer monitor (either a CRT or an LCD) should be of adjustable height.
2. If a work table of adjustable height is not available, use low tables for smaller workers and higher tables for larger workers to keep the keyboard at

elbow level. If only high tables are available, provide smaller workers with a high chair and a footrest positioned so that both their feet are flat on the footrest.

3. If a laptop is used, a flat panel LCD is preferred that the worker can use while raising the head with a better viewing angle, possibly together with an external keyboard.
4. Provide support for input devices such as a keyboard and a mouse. If a keyboard tray is used, position it below the elbow level. The mouse should be close to the worker so that no over-stretching occurs.
5. Organize the work items and workstation elements (e.g. overhead cabinet, desk light, document holder, etc.) to be within arm reach of the worker. The primary workspace within easy reach must accommodate the input device, while the secondary workspace is used for the monitor and document holder, etc.
6. To avoid clutter, cables should be bunched together in a special cable management facility.

SOME MORE HINTS

- Train users on correct sitting posture at the workstation. Educate users on the use of various controls on the adjustable chair.
- If a standing CPU is used, position it on the side of the table. Other items that are not required should be stored away (e.g. archive manuals, documents) to increase legroom.
- Schedule rest periods to enable stretching and visual exercises such as looking back and forth on far and close objects.

POINTS TO REMEMBER

Adjust table, chair, computer monitor, and keyboard heights to each worker. This is the first step towards reducing the incidence of musculoskeletal disorders and health complaints.

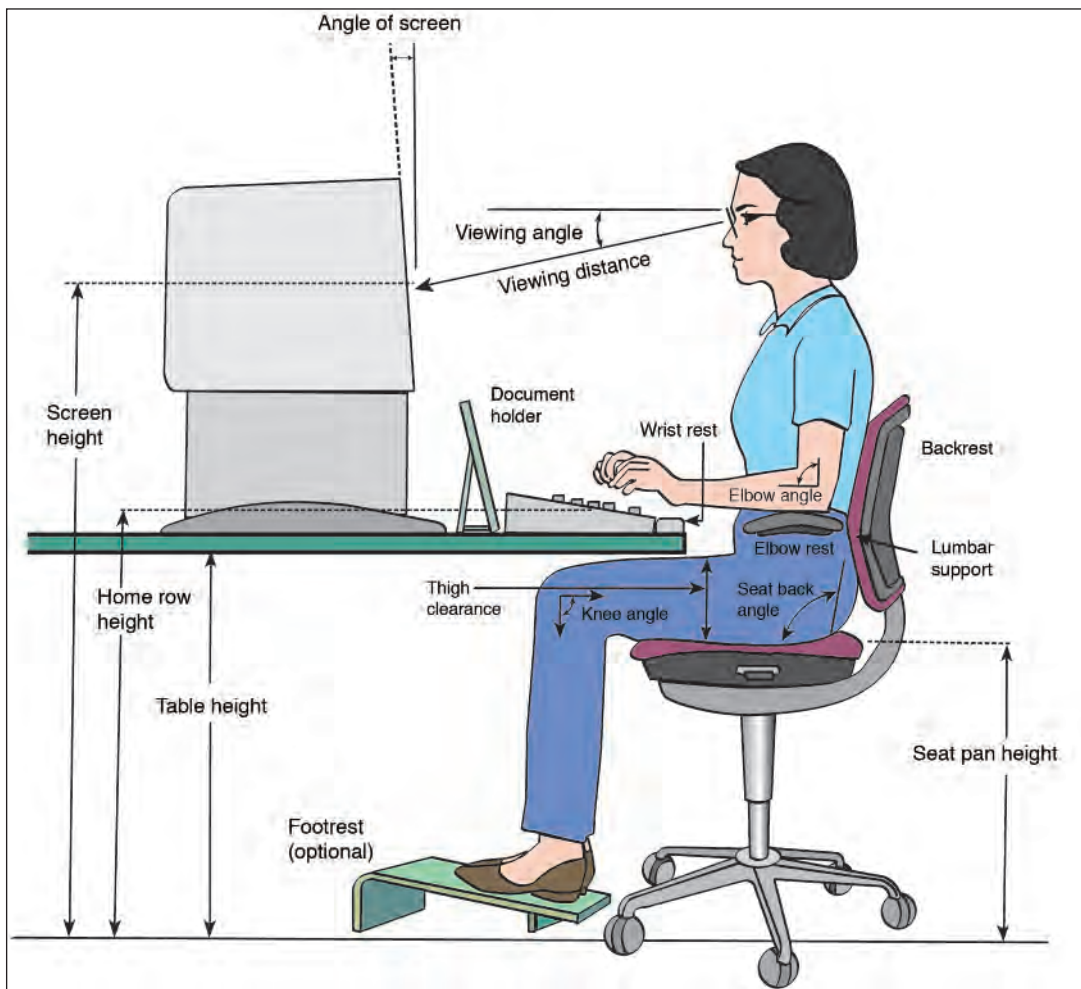

Figure 60a. Each visual display unit user must be able to find his or her best work positions.



Figure 60b. Arrange the computer workstation so that work is done comfortably. Train the operator about appropriate work postures and spatial arrangements.

CHECKPOINT 61

Provide eye examinations and appropriate glasses for workers using a visual display unit (VDU) regularly.

WHY

Most visual problems reported by computer or VDU workers are a result of, or related to, uncorrected or badly corrected vision.

Uncorrected eyesight adds to postural discomfort and neck and shoulder complaints. Many operators adopt a poor posture to compensate for their visual difficulties (e.g. bending forward to reduce the viewing distance, tilting the head to see better).

Few people have perfect vision, and many need corrective lenses specifically for VDU work.

Corrected vision has multiple effects: it reduces visual fatigue and headache, prevents neck, shoulder and back pain, and increases efficiency.

RISKS / SYMPTOMS

- eye strain
- upper limb disorder
- muscular strain

HOW

1. Anyone experiencing visual fatigue because of display-and-keyboard (VDU) work should undergo a full eye examination.
2. Provide eyesight correction specifically suited to VDU work. Lenses for one task may not be suitable for another task.
3. Check VDU operators' eyesight as part of a regular health check-up programme, at least once every two years. Inform your optician (vision care specialist) about the different visual tasks that you perform.
4. If a task is visually demanding it is important that regular pauses are taken to allow the eyes to recover.

SOME MORE HINTS

- Everybody knows that vision changes with age, accompanied by rapid reduction in visual performance. Yet there are many people who have not yet corrected their eyesight for their everyday work.
- Remember that requirements for corrective lenses for a VDU or computer screen are different from those for reading a paper copy. A display screen requires a longer viewing distance (more than 50 cm) and a viewing angle that cannot be reached by bifocal lenses.
- Regularly clean your glasses, screen and anti-glare filter.

POINTS TO REMEMBER

Minimize eye fatigue and postural discomfort from VDU work by wearing appropriate glasses wherever necessary, and by taking regular pauses to allow the eyes to recover.

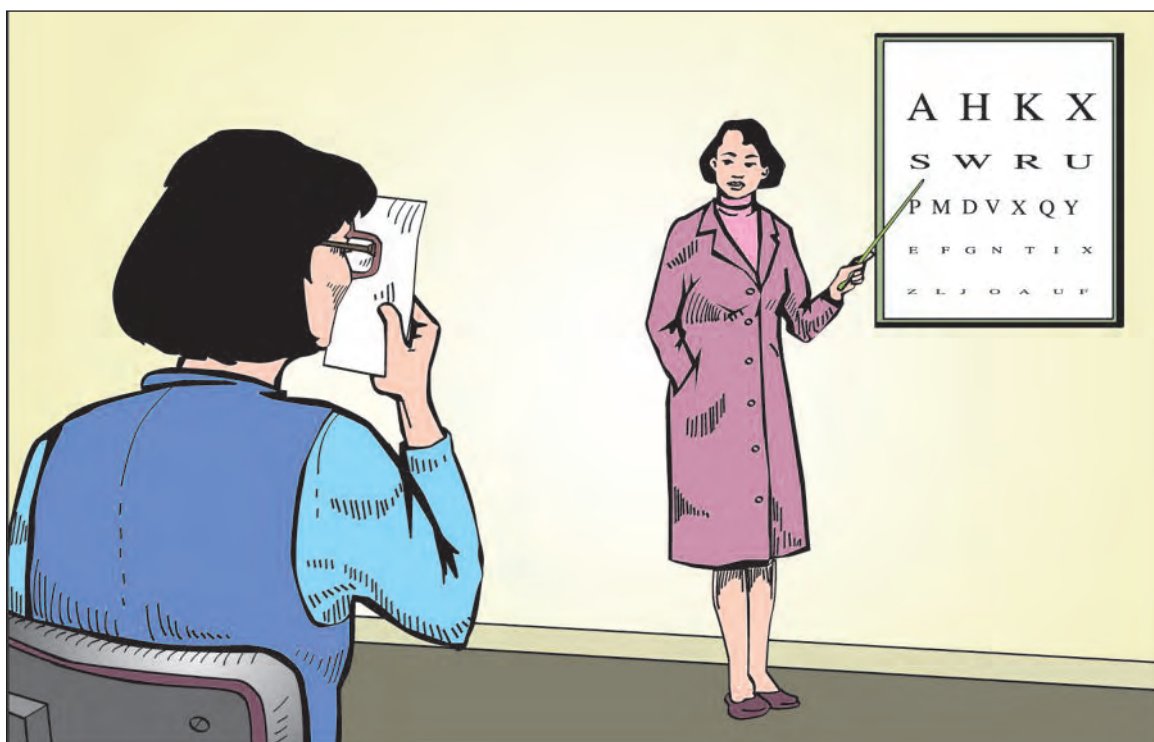

Figure 61a. Provide eye examinations for workers regularly using a VDU or computer.



Figure 61b. Provide eyesight correction specifically suited to visual display work.

CHECKPOINT 62

Provide a sound and stable footing and sufficient guarding arrangements for work in high places.

WHY

Work on elevated surfaces requires special guarding arrangements because fall from height causes serious injuries, often leading to fatal accidents. Special arrangements are needed for safe access, safe footing, scaffolds and protection from falls.

Access to elevated work areas is usually provided by ladders, stairs or lifting equipment. The means of access must be secure, easy to use and protected from falls.

A safe footing is absolutely essential for safe work on elevated surfaces. The elevated surfaces may be part of existing facilities or a temporary platform or scaffold. Good-quality work can only be achieved by an adequate set of arrangements.

Protection from falls should be provided both by adequate guarding of openings and footing platforms and by personal protective equipment. Both these measures must be combined on all elevated surfaces above a certain height.

RISKS / SYMPTOMS

- all from height
- slips, trips or stumbles
- muscular strain
- excessive fatigue
- pedestrian safety

HOW

1. Provide a firm and stable platform, floor or scaffold, equipped with appropriate safe means of access. The footing portion must be level and rigid without holes or obstacles that might cause stumbling. The footing must be capable of carrying the maximum intended load without settling or displacement.
2. When using a ladder to reach a high place, securely lash or otherwise fasten the ladder to prevent its slipping (with the horizontal distance from the base to the vertical plane of the support

approximately one-fourth of the ladder length between supports). Secure both bottom and top to prevent displacement.

3. Secure the scaffolds to the building in enough places to prevent scaffold collapse. Mount all uprights of the scaffolds on proper baseplates.
4. Attach stable guard rails of approximately 1 m in height, with midrails, along stairs and on all open sides of elevated places higher than about 0.7 m. Toeboards should be on the sides where objects falling may hurt other persons.
5. Make sure that the worker working on an elevated place higher than a designated level (e.g. 2 m or more depending on regulations) wears a safety belt or harness securely connected to a stable structure.
6. Platforms and scaffolds at height should be inspected by a competent person at least once a week and after windy and bad weather.

SOME MORE HINTS

- Sufficient clearance should be provided for work on a high place to ensure safe and efficient work.
- Put up safety nets for preventing falls where necessary.
- Establish safe practices of piling or placing loads on a high platform or scaffold to prevent their falling, rolling or dispersion.

POINTS TO REMEMBER

Sound, rigid and stable footing, with guarding against falling, is essential for safe and efficient work on a high place.

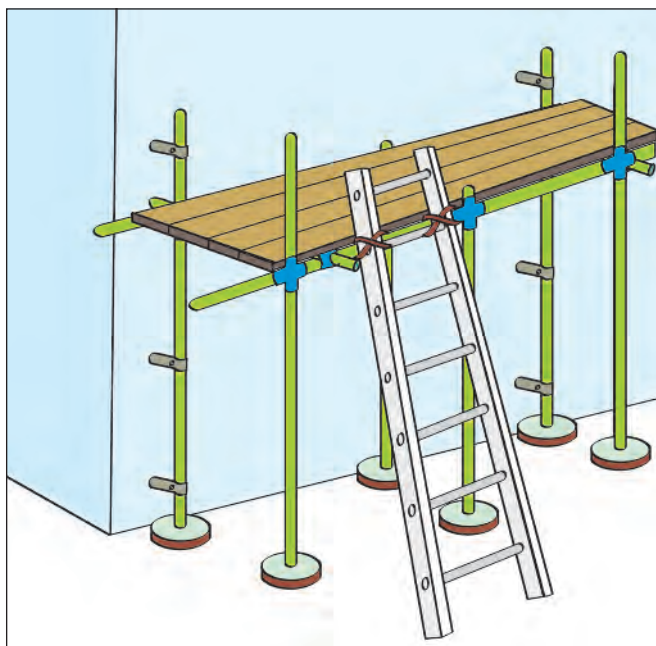

Figure 62a. Secure ladders at or near the top even if only used for a short time.

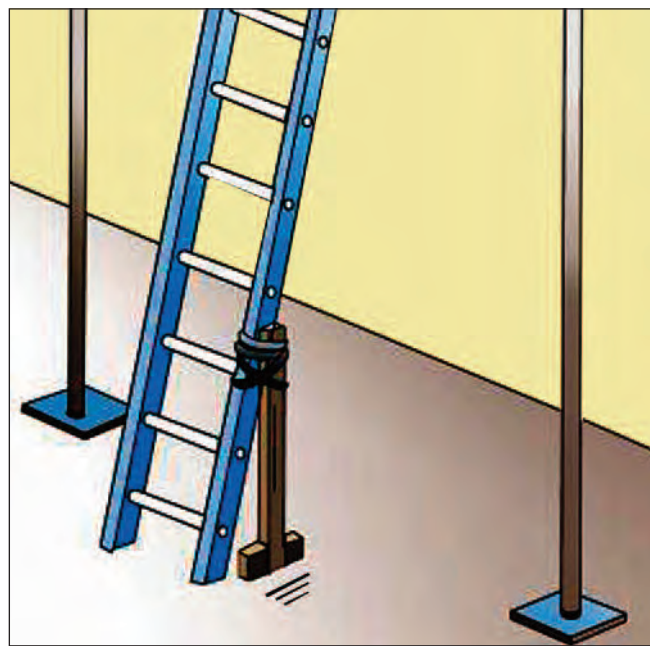

Figure 62b. Ensure that the footing of a ladder is secured in each local situation.



Figure 62c. Provide and use safety belts while working at height.

CHECKPOINT 63

Increase safety and comfort of driving cabins and seats of vehicles used at the workplace.

WHY

Vehicles are used in a variety of situations. Attention to safety and comfort of cabins is essential for increasing safety of drivers and people in the vicinity.

Accidents involving cabins and the drivers of workplace vehicles often lead to fatalities and other serious consequences. Typically, measures against the collision or overturning of vehicles can prevent and mitigate such consequences in many occasions.

Comfort in the driving cabin enhances the safety of workplace vehicles. Examples are protection from heat or cold, reduction in noise and vibration, good seat belts and visibility from the seated position.

RISKS / SYMPTOMS

- serious injury or accident
- muscular strain
- excessive heat or cold
- whole body vibration
- hearing loss
- exposure to hazardous chemicals

HOW

1. Make sure that the driving cabin has a stable structure that can prevent injury to the driver's head and other body parts in the case of a collision or overturning.
2. Provide easy access to the driver's seat and sturdy steps at appropriate height levels. Adequate grip handles may be helpful.
3. Make sure that the seat position is adjustable to all drivers using the vehicle. Confirm that seat belts do not cause any discomfort and that mirrors are adjusted each time a different driver uses the vehicle.
4. Examine the need to protect the driver from heat and cold. In long-hour operations in excessive heat or cold, enclosure or air-conditioning of the cabin may be necessary.

5. Examine the comfort of the driver, for example in terms of noise and vibration, visibility from the seated driver, and operations for going to different directions.

SOME MORE HINTS

- Put labels on important controls and displays so as to assist beginners in operating the vehicle in various situations.
- Provide a place to put a bottle of drinking water within easy reach from the seated position.
- Check whether operation of the vehicle disturbs the visibility of important displays.
- Ensure good visibility from the seated position considering drivers of different sizes.

POINTS TO REMEMBER

Safety and comfort of cabins are important for prevention and mitigation of serious consequences of a vehicle accident. Consider potential extreme conditions such as collisions and inexperienced drivers.

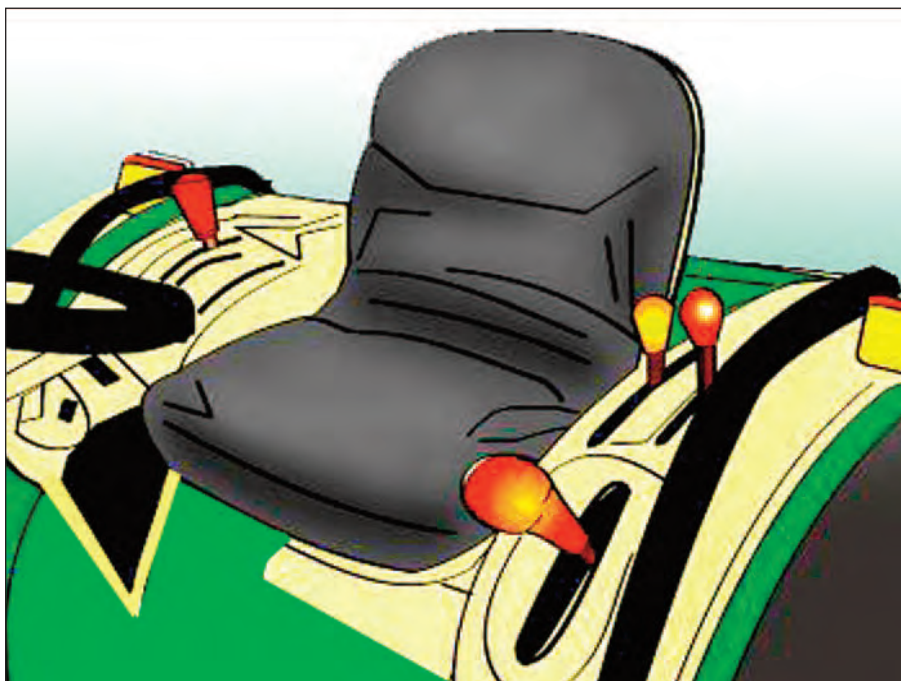

Figure 63a. Arrange the seat, leg space and controls for safe and comfortable driving operations.



Figure 63b. Provide mirrors and lights at appropriate positions to allow wide visibility in various operating situations.

Lighting



CHECKPOINT 64

Increase the use of daylight and provide an outside view.

WHY

Daylight is the best and cheapest source of illumination. The use of daylight reduces energy costs.

The distribution of light in the workplace can be improved by using more daylight. Measures to use daylight are effective for years to come, and greatly help to improve the efficiency and comfort of workers.

Using daylight is an environmentally friendly action.

RISKS / SYMPTOMS

- eye strain
- excessive fatigue
- no visual contact with outside
- increased injury rates

HOW

1. Clean windows and remove obstacles that prevent the entrance of daylight.
2. Change the place of work or the location of machines so that the worker has more daylight.
3. Expand the size of windows or have windows placed higher to take advantage of more daylight.
4. Separate switches for different electric lights or for different rows of lights so that parts of lighting can be turned off when there is enough daylight at workplaces near windows.
5. Install skylights with semi-transparent material at proper intervals. Skylights can be installed in the existing roof by simple replacement of a few roof panels with translucent plastic panels.

SOME MORE HINTS

- Combine daylight with artificial lights to improve your workplace lighting.
- Be careful, as windows and skylights provide heat in hot weather (and cause heat loss in cold weather).

- In a hot climate, orient windows and openings away from the direct heat of the sun or protect them from direct sunlight and UV radiation.

POINTS TO REMEMBER

The use of daylight reduces your electricity bills and is environmentally friendly.



Figure 64. Using daylight reduces energy costs.

CHECKPOINT 65

Use light colours for walls and ceilings when more light is needed.

WHY

The choice of colours for walls and ceilings is of great importance, because different colours have different reflectivity. White has the highest reflectivity (as high as 90 per cent), while dark colours have much lower percentages.

Light-coloured walls and ceilings are energy saving as they produce higher room illumination with fewer lights.

Light-coloured walls and ceilings make rooms more comfortable. This helps create an environment conducive to efficient work.

For precision and inspection tasks requiring accurate colour recognition, light-coloured surfaces are essential.

RISKS / SYMPTOMS

- eye strain
- increased injury rates

HOW

1. To provide adequate reflection of light, use a very light colour for ceilings, such as white (80–90 per cent reflectivity) and a pale tint for walls (50–85 per cent).
2. Avoid large differences between the brightness of walls and ceilings.
3. Do not use glossy or shiny materials or paints for the finish of these surfaces, in order to prevent indirect glare.
4. Use a combination of a white ceiling and lighting units with upward openings so that the ceiling reflects light from the units and the lighting units reflect light from the ceiling. This produces well-distributed general lighting.

SOME MORE HINTS

- Clean the walls and ceilings regularly as dust and dirt absorb a large proportion of light.
- Openings in the tops of lighting units not only allow ceiling illumination but also produce better light distribution and lower dirt accumulation than closed-top units.

POINTS TO REMEMBER

Light-coloured walls and ceilings create a comfortable and effective working environment.



(i) Before



(ii) After

Figure 65. (i) and (ii) Light colours for walls and ceilings improve lighting conditions and the workplace atmosphere.

CHECKPOINT 66

Light up corridors, staircases, ramps and other areas where people may walk or work.

WHY

Poorly lit or dark places cause accidents, especially when materials are being moved.

Staircases, back doors and storage rooms tend to be poorly lit and often become dumping sites. Often daylight does not reach staircases. Special attention to these areas is necessary.

Sufficient lighting in these areas can prevent injuries to people and damage to materials and products.

RISKS / SYMPTOMS

- slips, trips or stumbles
- eye strain
- increased injury rates

HOW

1. Clean windows and existing lights (lamps, fixtures, reflectors, covers) and change worn-out bulbs and tubes on staircases and ramps, and in corridors, storage rooms and other back-way areas.
2. Remove obstacles that prevent good distribution of light.
3. Relocate existing lights for better illumination of these areas. Add new lights after consulting workers.
4. Make best use of daylight by keeping some doors open or installing new windows or skylights.
5. Provide easy-to-reach electrical switches near the entrances and exits of corridors and staircases.
6. Paint surfaces with bright colours to make stairs and height differences clearly visible.

SOME MORE HINTS

- Lighting should be an important part of regular inspection and maintenance programmes.

- The level of illumination of staircases, corridors and storage areas may be lower than in production areas, but should be sufficient for safe moving and transport.
- Avoid automatic electrical switches if staircases, etc., are regularly used or if sudden shut-off may cause an accident.

POINTS TO REMEMBER

Better lighting on staircases and in corridors prevents accidents to workers and visitors, reduces product damage and improves the image of your enterprise.

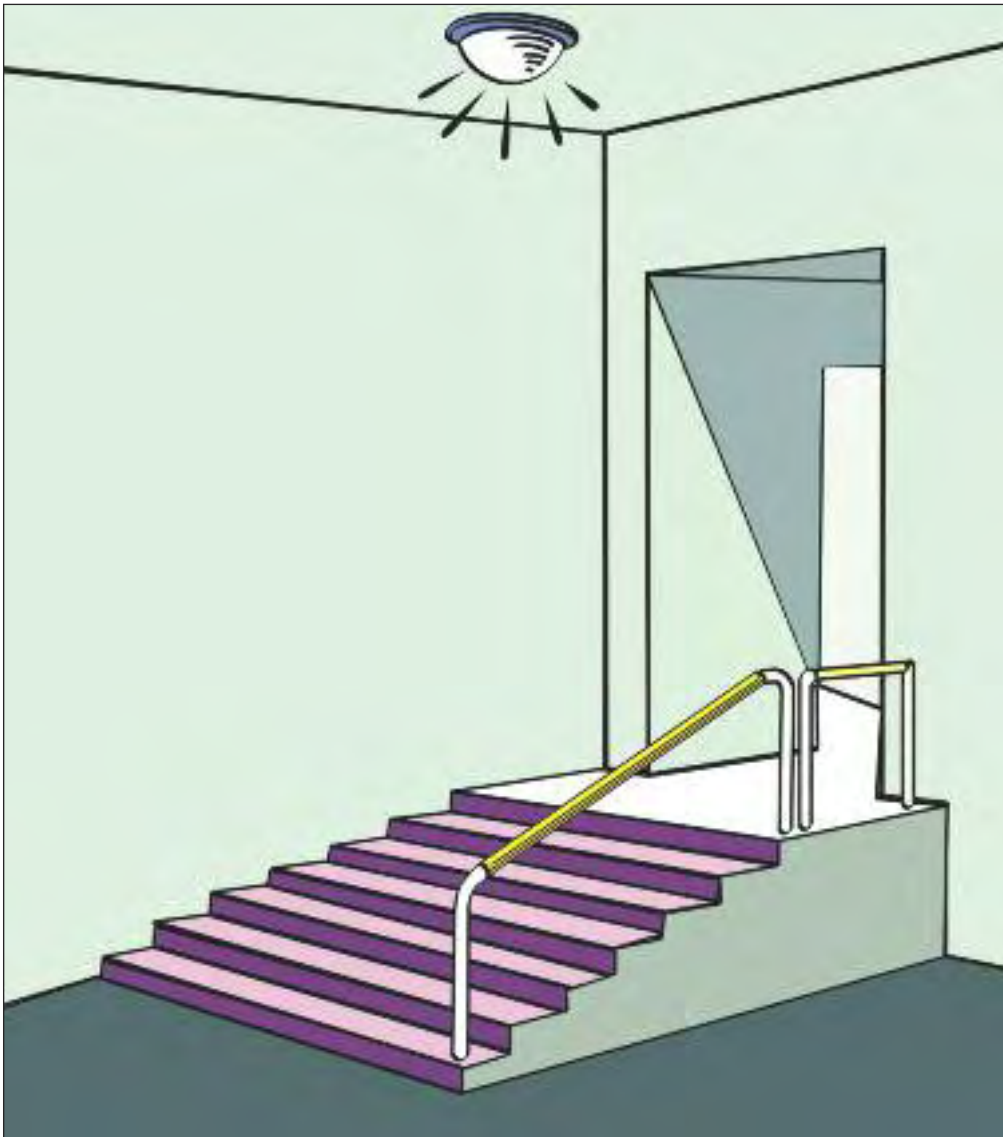

Figure 66. Good lighting on staircases and in corridors prevents accidents and reduces product damage.

CHECKPOINT 67

Light up the work area evenly to minimize changes in brightness.

WHY

Changing the view from a bright area to a dark area demands adaptation of the eyes. This takes time and is tiring.

It is more efficient and more comfortable to work in a room that does not have large variations in brightness.

It is important to suppress flickering light. Such lighting is annoying to everybody and causes eye fatigue. It even produces some odd effects dangerous to sufferers of epilepsy.

Sharp shadows on the work surface are a source of poor work quality, low productivity, eye strain, fatigue and sometimes accidents. Eliminate shadows.

RISKS / SYMPTOMS

- eye strain
- excessive fatigue
- epilepsy onset

HOW

1. Eliminate isolated pools of bright light. These are uneconomic and disturb the even illumination of the workplace.
2. Consider whether changing the height or positions of some existing lights can improve lighting so as to create more even illumination of the workplace. Consider whether adding some lights for general lighting can improve illumination.
3. At the same time as using daylight, light up workplaces away from windows if appropriate. For example, provide different switches for lights near windows and for lights illuminating places away from windows. In this way, the lights near windows can be turned off when there is enough daylight.
4. Eliminate shadow zones by having good distribution of lights and reflection from walls and ceilings, as well as by better layout of workstations.

5. Suppress flickering light by changing worn-out fluorescent lamps. If necessary, use other bulb types as well.

SOME MORE HINTS

- It is important not always to rely on installing electric lighting. A good combination of different means of improving lighting will help you a great deal. Use daylight properly. Use reflection from walls and ceilings. Combine general and local lights. Improve the layout of workstations.
- To attain even illumination, a mixture of direct and reflected light provides the best visibility. Install light units that have upward openings.
- In order to avoid the flickering (stroboscopic) effect of fluorescent lamps, which disturbs workers, consider the use of high-frequency fluorescent tubes or three-phase current connected to different fluorescent tubes. If nothing helps, try to cover the two ends of the tubes for about 10 cm at each end to mask the end flicker.
- For general lighting, it is often true that the higher the lights, the better the uniformity and dispersion of light.

POINTS TO REMEMBER

Avoid large differences in brightness in the workplace due to uneven distribution of bright lights and lack of adequate reflection.

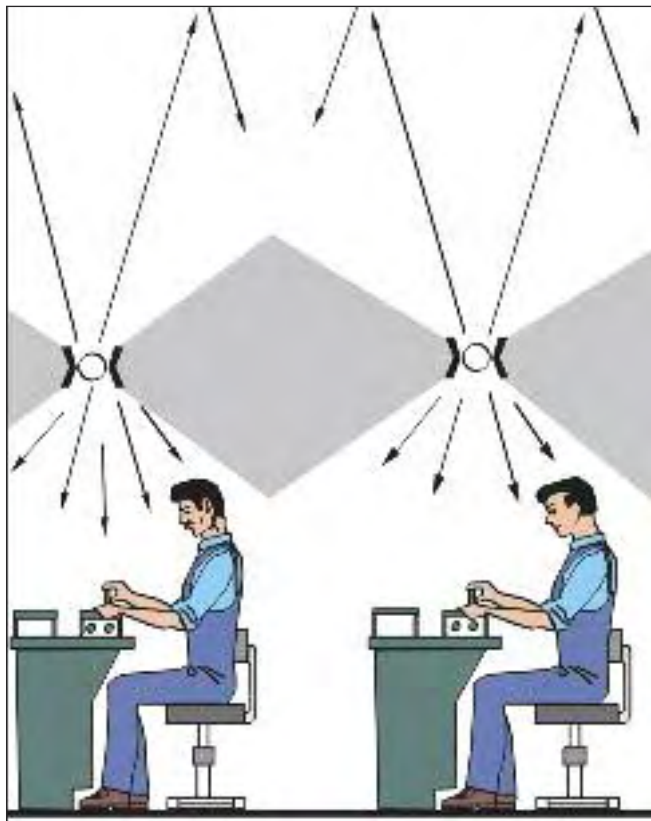

Figure 67a. A mixture of direct and reflected light provides the best visibility.

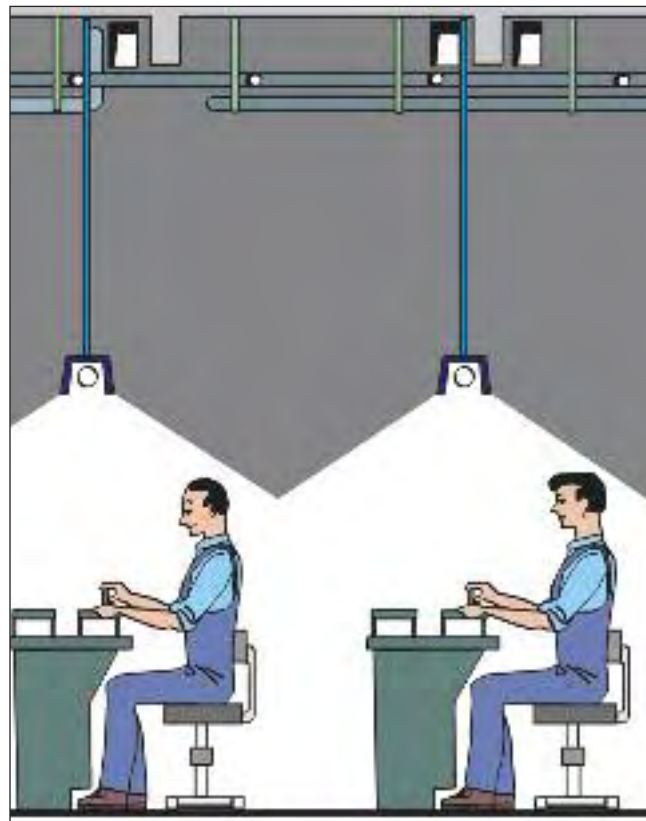

Figure 66b. Direct light.



Figure 66c. Sharp shadows make it difficult to work.

CHECKPOINT 68

Provide sufficient lighting for workers so that they can work efficiently and comfortably at all times.

WHY

Sufficient lighting improves workers' comfort and performance, making the workplace a pleasant place to work.

Sufficient lighting reduces work errors. It also helps to reduce the risk of accidents.

Adequate and good-quality lighting helps workers to see the work item quickly and in sufficient detail as the tasks require.

RISKS / SYMPTOMS

- eye strain
- wrong operation
- serious injury or accident

HOW

1. Combine the use of natural light (through windows and skylights) and artificial lighting (electric lights), as this is usually the most pleasant and cost-effective.
2. Provide sufficient lighting considering the nature of the tasks performed at various workstations. For example, more light is needed for precision work (seeing smaller objects) and for materials having lower reflective properties (e.g. work with dark-coloured cloth).
3. If appropriate, change the positions of lamps and the direction of light falling on objects. You can also try to change the positions of workstations to obtain better lighting from existing lamps.
4. Consider the age of your operators. Older workers need more light. For example, an operator aged 60 needs five times more light to read a printed text comfortably than a 20-year-old.
5. The level of lighting also depends on the time available for seeing objects. The faster the task (e.g. identifying defects on passing objects), the more and better arrangements of light are required.

SOME MORE HINTS

- Regularly maintain the existing lighting. Clean lamps, fixtures and reflectors, as well as windows, ceilings, walls and other interior surfaces. Change worn-out bulbs and tubes.
- Light-coloured walls reflect more light and provide better lighting conditions and a good workplace atmosphere.
- Most people over the age of 40 need glasses. Regular vision checks are recommended as part of the workers' health programme.

POINTS TO REMEMBER

Provide sufficient and good-quality lighting at minimum cost. There are various ways to improve lighting.

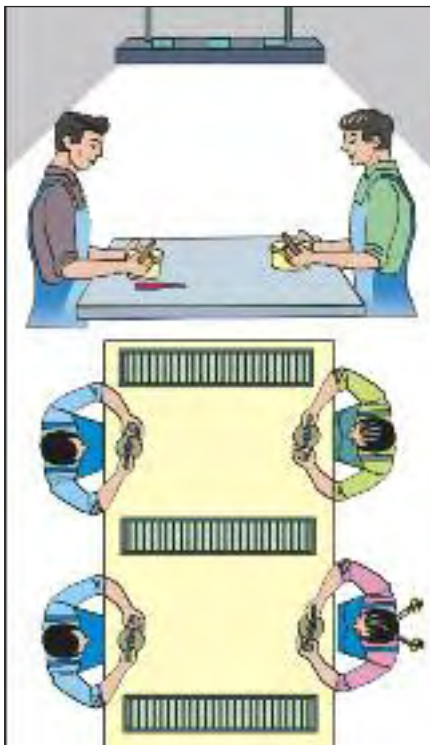
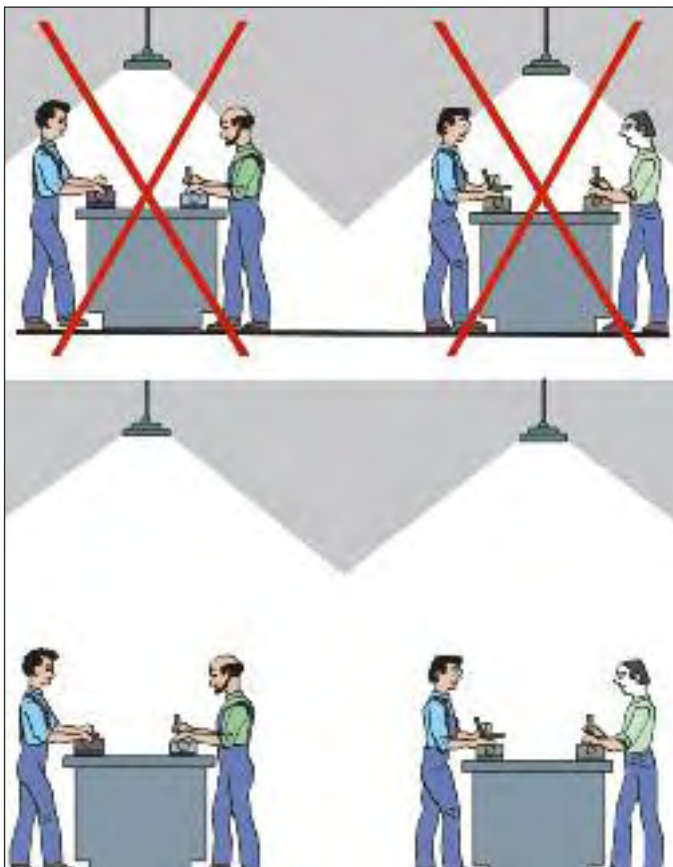

Figure 68a.
Bench lighting
for work with
larger objects.



(i)
Before

(ii)
After

Figure 68b. (i) and (ii) Higher lighting gives better dispersion.

CHECKPOINT 69

Provide local lights for precision or inspection work.

WHY

More light is required for precision or inspection work than for normal production or office work.

Appropriately placed local lights greatly improve the safety and efficiency of precision or inspection work.

A combination of general and local lights helps to meet the specific requirements of different jobs and helps to prevent disturbing shadows.

RISKS / SYMPTOMS

- eye strain
- serious injury or accident
- wrong operation
- glare

HOW

1. Place local lights near and above precision work and inspection work. The local lights having a proper shield should be in a position where they will create neither glare for the worker nor disturbing shadows. No naked bulb should be used as a local light.
2. Where appropriate, use local lights that are easy to move and arrange in the desired positions.
3. Use local lights that are easy to clean and easy to maintain.
4. Use daylight bulbs or tubes (white fluorescent bulbs or tubes) for colour recognition tasks.
5. Always ensure a good combination of general and local lights so that each workstation has an appropriate contrast between the work-point and the background.

SOME MORE HINTS

- Make sure that local lighting does not restrict the operator's view.

- When using a local light, mount it on a rigid isolated structure instead of on vibrating machines.
- Use deep lampshades for local lights and paint the inner edge of the shades in a dark matt colour to prevent bright reflections.
- Local lights with filament tubes produce heat, often resulting in discomfort for the worker. Use fluorescent lamps instead. Various kinds of fluorescent lamp are available.

POINTS TO REMEMBER

Local lights, properly placed, reduce energy costs and are surprisingly effective.



Figure 69a. A combination of general and local lights helps to meet the specific requirements of different jobs.

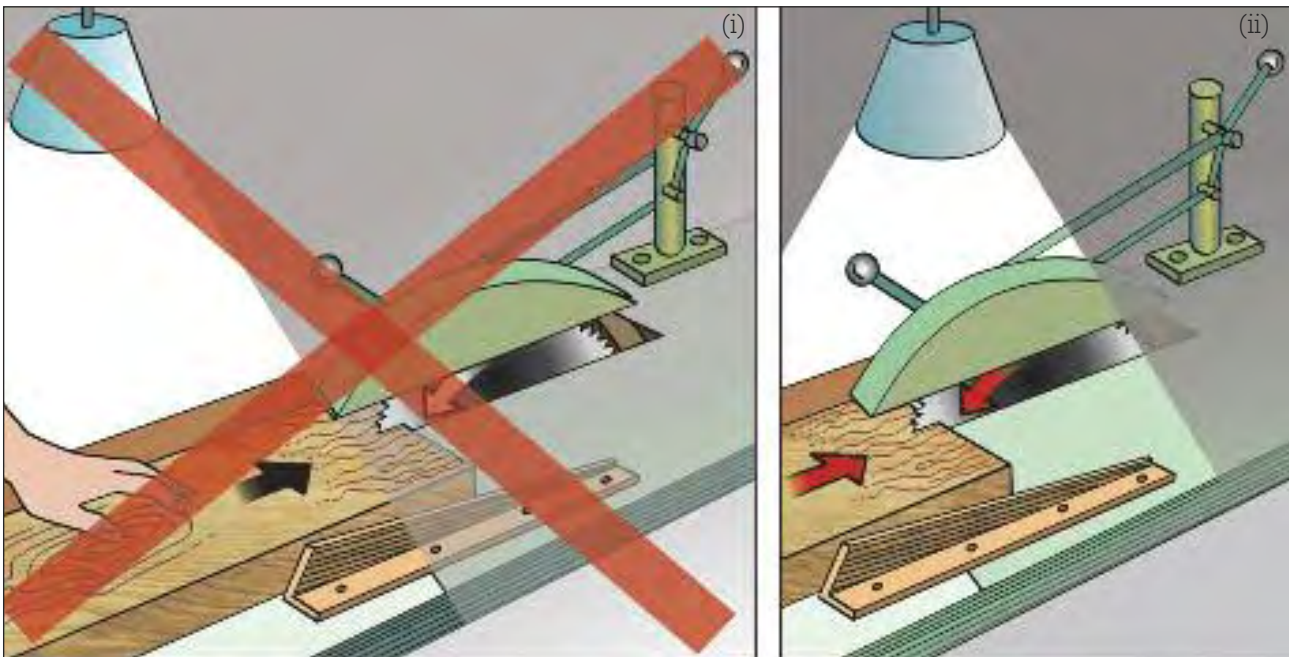

Figure 69b. (i) and (ii) Repositioning of a light source to improve safety and efficiency.

CHECKPOINT 70

Relocate light sources or provide shields to eliminate direct and indirect glare.

WHY

Direct or reflected indirect glare greatly reduces everyone's ability to see. For example, the image of bright overhead lights reflected in a display screen disturbs screen reading.

Glare at work is a cause of discomfort, annoyance and eye fatigue. Glare also reduces the worker's performance, causing low work quality and low productivity.

There are means to eliminate glare. Eliminating direct glare from windows or light sources, as well as indirect glare from reflections, reduces workers' complaints and allows for more efficient use of machines.

RISKS / SYMPTOMS

- glare
- eye strain

HOW

1. Place display panels or screens in a place not facing the window, owing to the potential for direct glare. Indirect glare with the window behind can also be a problem for the CRT monitor. This is reduced with LCD monitors.
2. Do not position any naked light bulbs or tubes within the field of vision of workstations.
3. Relocate overhead lamps or raise them so that they are well outside the normal field of vision of workers. Place workstations with display screens between rows of overhead lights so that such lights are not directly above the workstation and the operator's line of sight is parallel to the overhead lights.
4. Reduce glare from windows or neighbouring workstations by using curtains, blinds, partitions or desktop partitions.

5. Mount local lights (task lights) low enough and shade them well to hide all bulbs and bright surfaces from the normal field of vision.
6. Change the direction of light coming to the workstation in order to avoid glare, e.g. so that workers, instead of facing the light source, now have their sides or backs towards it.

SOME MORE HINTS

- Change the window glass to translucent glass instead of transparent glass.
- For local lights placed near the point of work, use deep lampshades and paint the inner edge of the shades in a dark matt colour. If appropriate, use shields between the lights and the eyes or between the lights and the display screen.
- Eliminate distracting reflection and glare by reducing overhead lighting (turning off some lights, where possible, and providing desk lamps for workers), drawing curtains or adjusting the blinds. Naturally make sure that there is sufficient light for performing the various tasks required.
- Use medium-reflectance and low-contrast walls, ceilings and floor surfaces (do not use colours that are too bright or of high contrast with the computer screen, or very dark and gloomy colours).
- Use indirect upward lighting to distribute the light over a greater area of the ceiling. The reflected light coming from the ceiling helps to eliminate over-bright spots and to minimize glare.

POINTS TO REMEMBER

By avoiding direct and indirect glare you can greatly improve the visibility of work items without increasing light intensity. Glare-free work greatly enhances work quality and reduces workers' discomfort.



Figure 70a. A shaded lamp should be placed at the appropriate height.

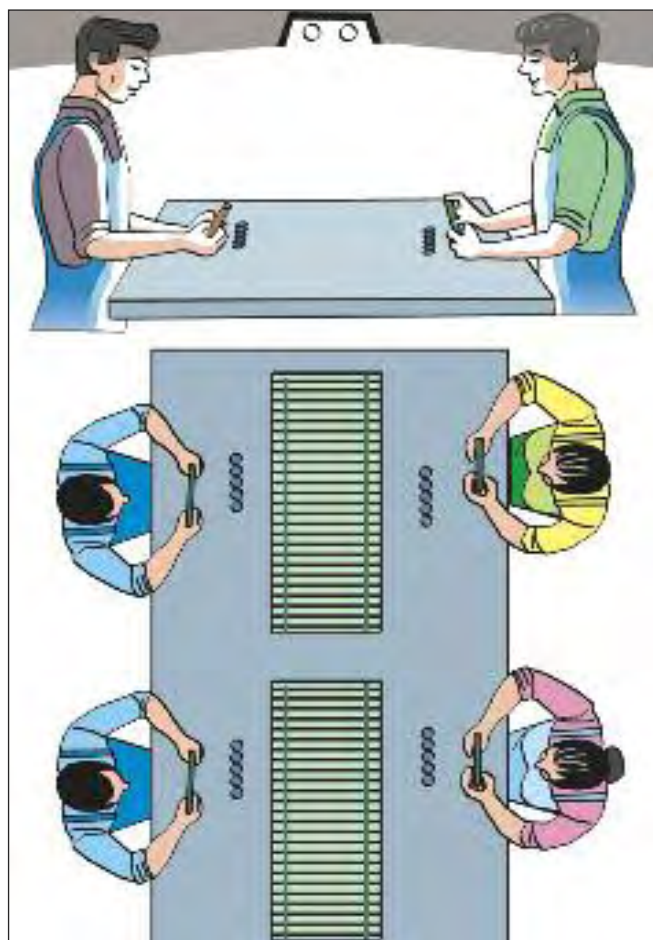

Figure 70b. Bench lighting for work with small objects.



Figure 70c. Reflected (indirect) glare reduces visibility.



Figure 70d. Glare reflected from a polished surface.

CHECKPOINT 71

Choose an appropriate visual task background for tasks requiring close, continuous attention.

WHY

Visual tasks that demand close, continuous attention are performed with much less strain if their background is free from eye-catching distractions.

When the workpiece is small and held close to the eyes, a plain background without disturbance to the eyes is particularly important for high-quality work.

Workers doing critical assembly or precision work may be seriously distracted by neighbouring operations, such as moving machines or machine parts, or hand movements of a second worker sitting opposite. Simple measures can prevent such distractions.

RISKS / SYMPTOMS

- eye strain
- visual distraction
- wrong operation

HOW

1. Place a screen giving a plain visual background behind the point of operation so as to shield eye-catching distractions.
2. Place a partition between neighbouring workstations when the operations at one workstation distract workers carrying out operations at the other. Similarly, place a desktop partition between workers doing operations at the same workbench or work table.
3. If necessary to see clearly the outlines of small, flat objects, use a sheet of light-diffusing glass or plastic that is lit from behind by lamps or reflectors.
4. Avoid shadows thrown on the object against a brighter background; relocate the light source so that the light comes from above or from over the shoulder of the worker instead of coming from behind the visual task.

SOME MORE HINTS

- An appropriate jig on which a work item is placed with clear separation from other things often helps obtain clear vision of the work item.
- Partitions placed between neighbouring workstations and neighbouring workers should not disturb communication between workers. For example, desktop partitions should be low enough to allow some visual and verbal contact between workers.
- Avoid prolonged work in an isolated pool of light in the middle of a darkened interior. In such a case, the eyes become fatigued as they have to readjust every time the worker looks away from the brightly lit work-point.

POINTS TO REMEMBER

The elimination of potential distractions from the visual task background greatly contributes to efficiency and safety.



Figure 71a. A low partition helps to avoid visual distraction.

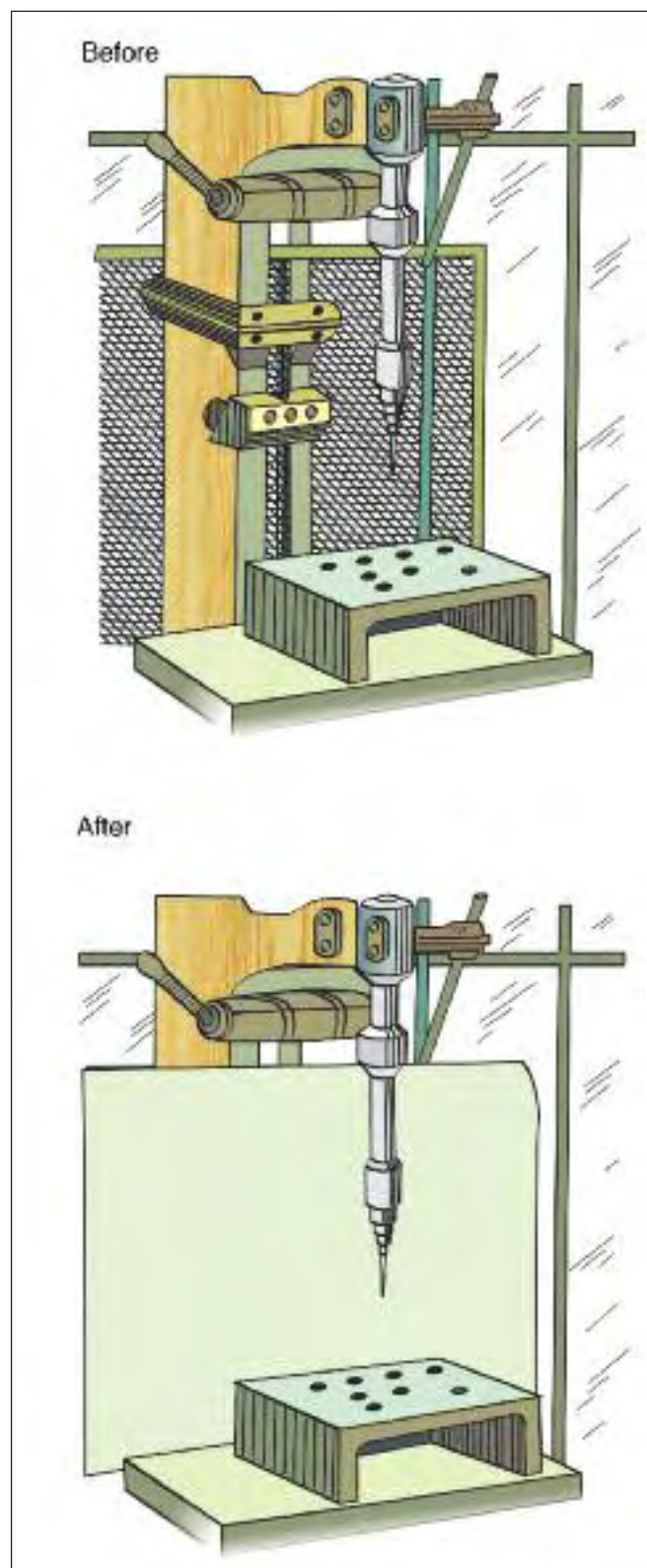

Figure 71b. Elimination of distracting details with the help of a screen.

CHECKPOINT 72

Clean windows and maintain light sources.

WHY

Poorly cleaned or maintained light sources may reduce lighting annually by a large percentage. Gradual deterioration of lighting goes unnoticed, making it a hidden source of poor-quality work and accidents.

Well-maintained and clean windows and light units reduce energy consumption by increasing daylight and by producing more light with less wattage.

The maintenance of light units increases the service life of bulbs and tubes. Timely replacement of worn-out fluorescent tubes prevents problems from flickering lights.

RISKS / SYMPTOMS

- eye strain
- increased injury rates

HOW

1. Make cleaning of windows and light units a regular part of the weekly routine. Assign cleaning responsibility to a trained person who also understands the danger of electric shocks.
2. Ensure that maintenance personnel have at their disposal appropriate cleaning tools and ladders to reach the lighting units and windows.
3. Incorporate the replacement of worn-out bulbs and tubes as part of this maintenance programme. Encourage workers to report lighting problems and worn-out bulbs and tubes to those in charge of lighting maintenance.
4. As much as possible, use light units that have openings at the top, as these openings allow an upward warm airstream that helps to keep the reflectors clean.

SOME MORE HINTS

- When cleaning, use mild and non-abrasive detergents to avoid corrosion of the reflectors. Use

water sparingly to make cleaning effective, and to minimize the risk of accidents involving electricity.

- Note that the service life of various types of lamp varies widely. Ordinary filament bulbs may last approximately 700 hours; a fluorescent tube may last ten times longer.
- If the electrical lights are numerous, it may be economical to change all bulbs or tubes at fixed time periods. The leftover bulbs or tubes that are still working can be used for individual replacements before the predetermined point of time.
- Changing worn-out, corroded or stained reflectors is more economical than replacing the whole light unit. Aluminium foil is a good material or replacement for a reflector.

POINTS TO REMEMBER

Start a cleaning and maintenance programme for light sources and windows by designating persons responsible for it.



Figure 72. Clean windows and well-maintained light sources help to increase lighting.

Premises

CHECKPOINT 73

Protect workers from excessive heat.

WHY

Excessive heat can strongly influence working capacity. It may greatly decrease productivity and may increase errors and accidents.

Heat stress increases fatigue and may lead to heat-induced illnesses.

It is often difficult to control the workplace temperature. Hot process areas may be an unavoidable part of production. Regulation of temperatures may be impractical on production sites in a tropical climate, especially when the workroom air is polluted with dust or chemicals arising from production. In such a case, it is important to provide available means of protection against excessive exposure to heat.

RISKS / SYMPTOMS

- heat stress
- thermal discomfort
- excessive fatigue

HOW

1. Try multiple available measures to bring down the workplace air temperature. This is important when air conditioning is not possible. Measures should include protection from outside heat coming into the workplace (solar heat), increased natural ventilation, isolation from hot machines and processes, and the provision of local exhaust systems for heated and polluted air.
2. Protect workers from heat radiation from hot machines and equipment, and from hot surfaces (e.g. heated roofs or walls). The best way to reduce radiation reaching the workers is to put screens or barriers between the radiation source and the body. Also use insulated ceilings and walls. Where exposure to excessive heat is unavoidable, minimize the exposure time and provide protective clothing that can protect workers from heat radiation.
3. Avoid physically heavy work for workers who are exposed to high temperatures or to strong heat

radiation. Mechanize such work, or introduce rotation of workers so that the duration of exposure to excessive heat per worker is reduced.

4. Increase air velocity around the work area by means of fans and ventilators.
5. If possible construct, inside the workplace, a small air-conditioned operation booth or room so that operators can stay in it for most of their working time.
6. Minimize the period of time during which workers are exposed to high temperatures or to strong heat radiation (e.g. by approaching the area only when absolutely necessary, or by creating a work area behind a heat barrier so that the workers can avoid exposure to strong heat radiation). A rest corner with good natural ventilation or fans, rotation schemes or frequent breaks can also help.
7. Provide a supply of cold mineral drinking water for those workers in the hot environment.

SOME MORE HINTS

- It is often necessary or useful to combine the measures mentioned above. Avoid long hours of hot work and ensure sufficient breaks, especially during physically heavy work.
- Check whether excessive heat is causing problems for product quality or for workers' health (e.g. by comparing work results between hot and cooler months or by interviewing workers).
- Liquids should be taken in small quantities and often.
- Provide good washing facilities and access to laundering of work clothes.

POINTS TO REMEMBER

There are many ways to reduce exposure to excessive heat. Take multiple measures, and provide sufficient breaks and cool drinking water.

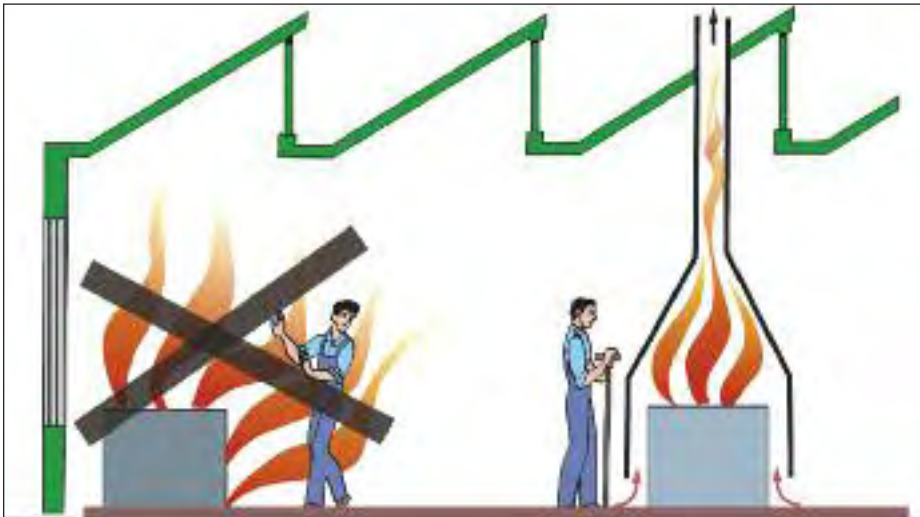

Figure 73a. Use of local exhaust against heat radiation and pollution.

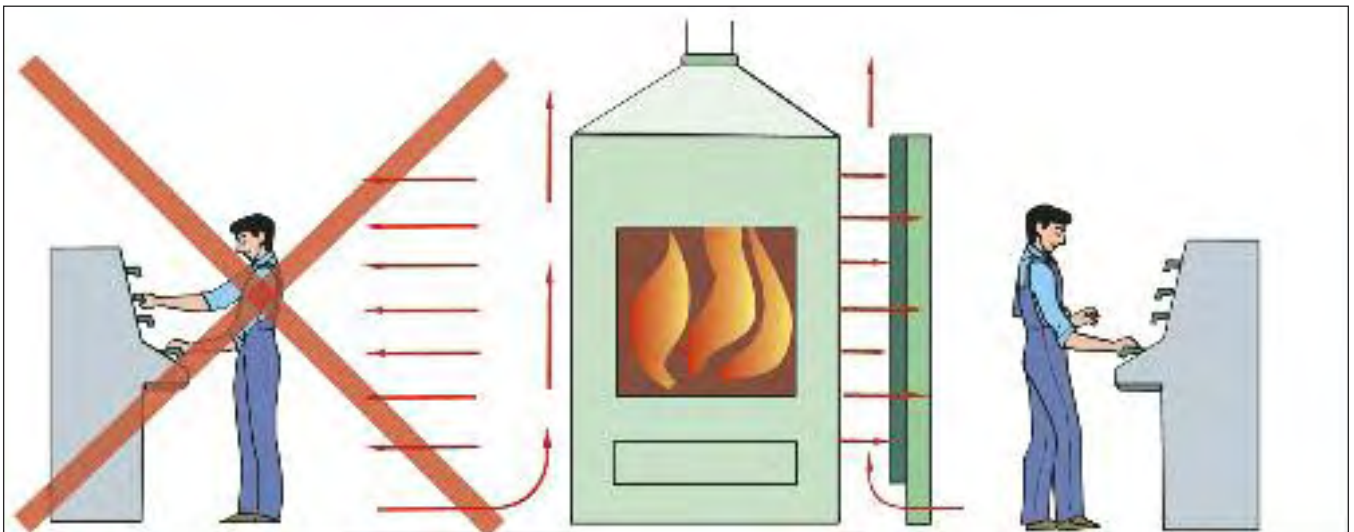

Figure 73b. Use of an absorbent shield to block heat radiation.

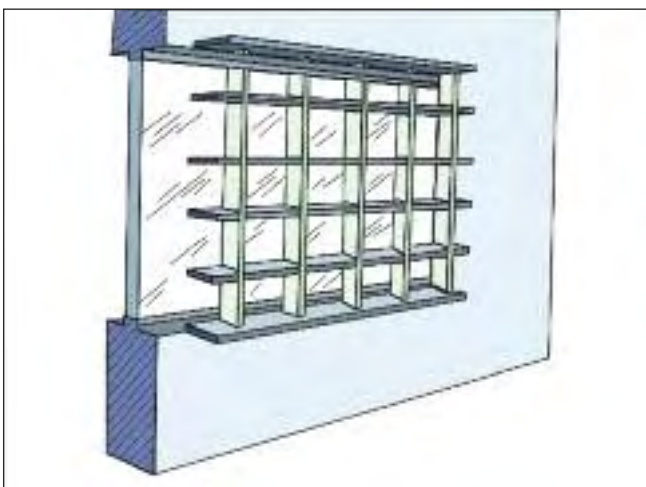

Figure 73c. External rectangular matrix structure against solar radiation.

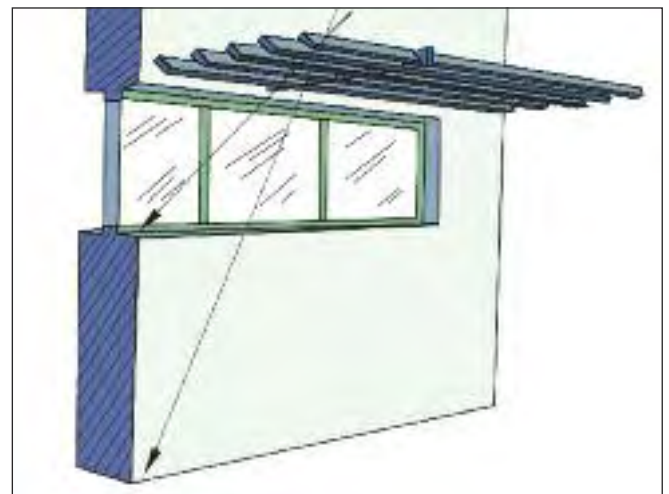

Figure 73d. A canopy made of a row of planks provides good protection against heat penetration and better lighting conditions than a solid canopy.

CHECKPOINT 74

Protect workers from cold work environments.

WHY

Cold environments may increase a range of safety risks and health disorders for workers, and decrease their productivity. The capacity of work requiring coordination decreases if the worker is exposed to the cold for a prolonged period. A loss of concentration from discomfort affects safety. Muscle strength declines when muscle temperature falls below 28°C. Even if the core body is warm, hand dexterity begins to decline when skin temperatures fall to 15–20°C. It is necessary to prevent these effects by reducing exposure to cold.

The common danger of frostbite may occur in cold environments, particularly to areas of the skin exposed to the cold. Protection of the hands and the feet requires special attention.

Repeated exposure to cold work environments can increase the risks of cumulative musculoskeletal disorders, especially if the work is done by exerting forces when the body is cold. Ergonomic work methods can effectively prevent these risks.

Continued intense physical work in cold environments results in sweating, which can be harmful to health, especially when followed by periods of sedentary work.

Excessively long exposure to the cold may result in permanent damage to the tissue and may even lead to hypothermia. This can occur for those who work outside in an extremely cold environment as well as in refrigerated facilities. This should be prevented by improving work schedules and teamwork.

RISKS / SYMPTOMS

- excessive exposure to cold
- frostbite
- muscular strain
- low back pain
- stress-induced disorder
- increased injury rates

HOW

1. Use multiple-layer clothing, with windproof clothes as the outside layer, and gloves for work in cold environments.

2. For internal workplaces in a cold climate, insulate the building and the workroom to minimize the effects on workroom temperature. Reduce cold air velocity to minimize the chill effect of the air movement.
3. In heavy work, wear a number of layers of clothes that can be removed one by one to avoid overheating. Clothes with zip fasteners may also help. Balance work rates so that periods of intense work in cold environments are followed by low work rates in warmer environments. Provide opportunities and equipment to dry wet clothing.
4. Redesign machinery and tasks carefully to make them easier to perform and less hazardous. Examples are the larger size and spacing of knobs, insulation of metal parts, elimination of sharp protrusions, etc.
5. Provide comfortable, heated rest facilities.

SOME MORE HINTS

- Workers should be paired with others for work in cold environments, with instructions to watch for signs of excessive effects of cold in each other.
- Bulky clothing can be dangerous as it interferes with movements or can be easily caught in moving parts of machines. This also applies to thick gloves. It is necessary to provide appropriate clothing and gloves.
- Use spot heaters giving radiant heat in areas where workers need local heating.

POINTS TO REMEMBER

Protecting workers from cold environments requires a range of practical solutions. Pay attention to balanced work assignments, clothing and gloves, easier and safer work and rest facilities.



Figure 74a. Provide adequate work space and clothing for protecting workers from cold environments and other potential hazards.



Figure 74b. Use multiple-layer clothing and gloves, with windproof clothes as the outside layer, for work in cold environments.

CHECKPOINT 75

Isolate or insulate sources of heat or cold.

WHY

Hot machines or hot processes greatly add to heat stress. This is because they warm up the workroom air and because heat radiation from them directly warms up the workers.

Isolation or insulation of these hot machines or processes can reduce both the heating up of workroom air and the effects of radiation. Therefore this is a very effective way of protecting workers from heat stress.

The isolation or insulation of heat sources has a triple effect: it can keep heat in; it reduces fuel costs; and it improves work quality and comfort of workers in the workplace itself and in neighbouring workplaces.

Working in an environment exposed to cold processes also requires special protection. Cold conditions can cause frostbite, excessive heat loss and serious health consequences. Insulation can effectively prevent these effects.

RISKS / SYMPTOMS

- burns
- thermal discomfort
- heat stress
- frostbite
- increased injury rates

HOW

1. Locate sources of heat or cold (machines and processes) outside or at least near the exterior so that heat can escape or so that cold does not have too great an effect.
2. Insulate hot or cold parts by using appropriate insulating material such as foam or polyester over metallic surfaces. Note that not all insulating materials tolerate high temperatures. However, avoid materials containing asbestos.
3. Use shields (heat barriers) between a hot oven or other radiant heat source and the worker. A good shield is made of reflective material. Water curtains or wooden or fabric-covered partitions also cut the radiating heat efficiently.

4. In the case of cold processes, insulation is the most efficient way to protect workers from injuries and heat loss.

SOME MORE HINTS

- An alternative to insulation is the use of personal protective clothing to reduce heat radiation. In tropical conditions, however, personal protection from heat is less efficient and the main emphasis is on insulation, guards and increased air flow.
- Heat-protective aprons or clothing (e.g. aluminium-coated garments) are effective against radiant heat. If, however, air temperature and humidity are high, such clothing may have adverse effects by making the worker very uncomfortable, because perspiration is not allowed to evaporate. Working in hot conditions can become dangerous if measures are not taken to prevent heat exhaustion. In this case, additional measures may be necessary to provide a strong or constant air flow inside the protective clothing.
- Automation of tasks in hot environments may in some cases be the only solution to avoiding heat-related problems. Air-conditioned booths can sometimes be one of the best available solutions.
- In cold conditions, the use of vibrating tools increases the risk of white-finger disease. Hands and feet need particular protection. If through insulation or good working clothes the whole body is warm and comfortable, hands and feet also remain warm.

POINTS TO REMEMBER

Insulate the surfaces of hot machines and processes, and use heat barriers to prevent radiant heat from reaching the worker. Both of these greatly reduce heat stress in workers.



Figure 75a. Where exposure to excessive heat sources is unavoidable, minimize the exposure time and provide clothing that can protect workers from heat radiation. Remember to take measures to prevent heat exhaustion.

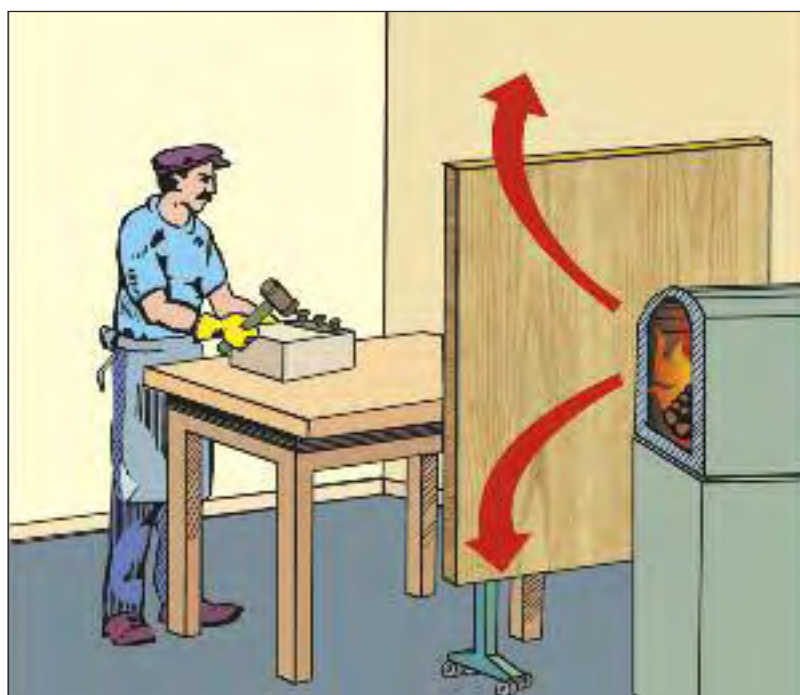

Figure 75b. Heat barriers prevent radiant heat from reaching the worker, which reduces heat stress.

CHECKPOINT 76

Install effective local exhaust systems that allow efficient and safe work.

WHY

Hazardous substances, dust and smoke in the air are a source of ill health. If workers fall sick as a result of being exposed to such substances, it will cost you much the same as accidents do. Even before the workers suffer from diseases, exposure to hazardous substances, dust, fumes and smoke may cause fatigue, headache, dizziness and irritation of the eyes and throat, and workers cannot work efficiently. Absenteeism and turnover of workers may increase. Local exhaust is an effective way to prevent all these problems.

When exhaust ventilation is used, it is important to use suitable types of hood or flange at appropriate places. Otherwise, polluted air may have difficulty in being expelled from the workplace.

RISKS / SYMPTOMS

- excessive fatigue
- dizziness or headache
- eye, skin and mucous membrane irritation
- exposure to hazardous substances

HOW

1. Use an enclosing-type exhaust system if the substances are very harmful or the area to be ventilated is narrow. You can achieve the highest ventilation effect with an enclosing-type system.
2. If an enclosing-type system is not realistic, use hoods and flanges together with the exhaust ventilators. Hoods and flanges limit the air flow from unnecessary directions and thus increase the efficiency of collecting the polluted air.
3. Provide shutters or curtains to the inlets of exhaust ducts or hoods, and close them when the ducts or hoods are not in use. You can increase the power of ventilation for other work areas where this is needed. You can also increase the efficiency of ventilation by narrowing unnecessary parts of the inlet with a shutter or curtain.

4. Use shields, partitions and barriers to increase ventilation efficiency from the pollution source to the inlets of the exhaust ducts. Close windows near the exhaust inlet or provide partitions around the hoods to avoid the disturbing effects of draughts.
5. Use a portable suction exhaust if the pollution source changes as the worker performs the work that produces hazardous substances (e.g. welding).

SOME MORE HINTS

- Different types of cover or hood with built-in extractors can be connected to hand-operated machines such as grinders. Place a cover or hood so that flying particles can automatically and easily be sucked into the extractors.
- Place hoods considering air flow. Hot air rises, so hoods above the heat sources are more efficient than others.
- If the hood is set in the direction of natural air flow or the expected flow of hazardous gases, the efficiency becomes high.
- If a local exhaust system cannot be arranged, or the existing exhaust system is still insufficient, workers should be provided with adequate respirators.

POINTS TO REMEMBER

Removing dust, fumes and gases at source, before they reach workers, is usually the most cost-effective way to prevent their inhalation. Use effective local exhaust systems if enclosing systems cannot be applied.

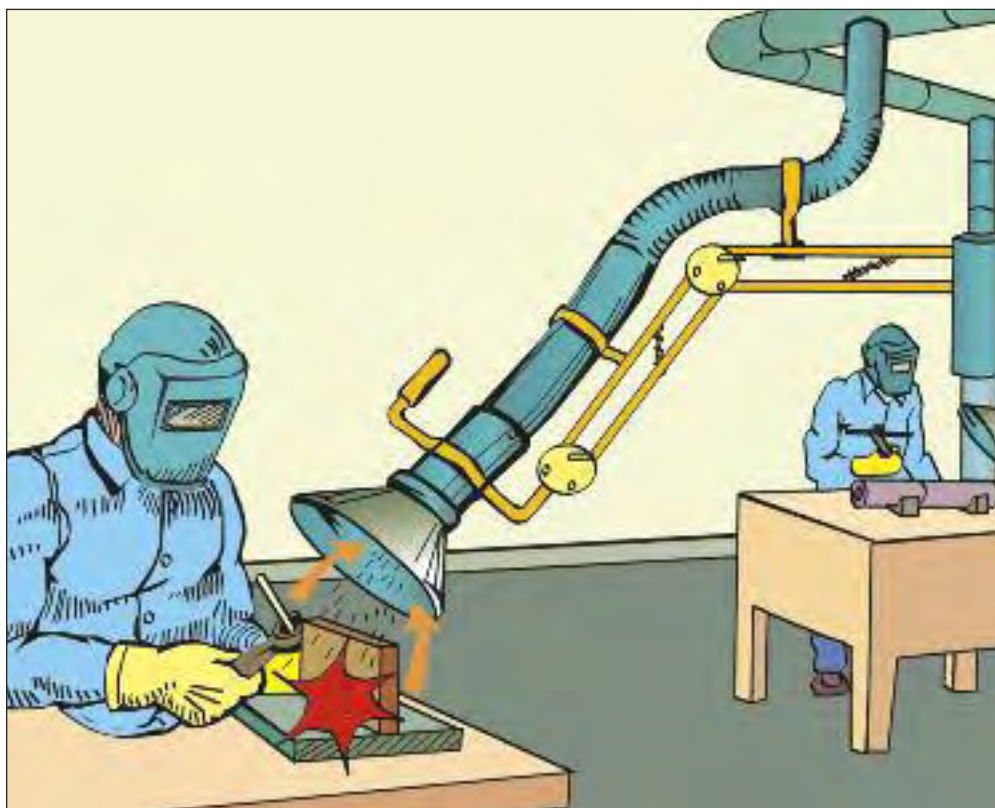

Figure 76a. When enclosing systems cannot be applied, use local exhaust systems to remove dust and gases at source before they reach the worker.

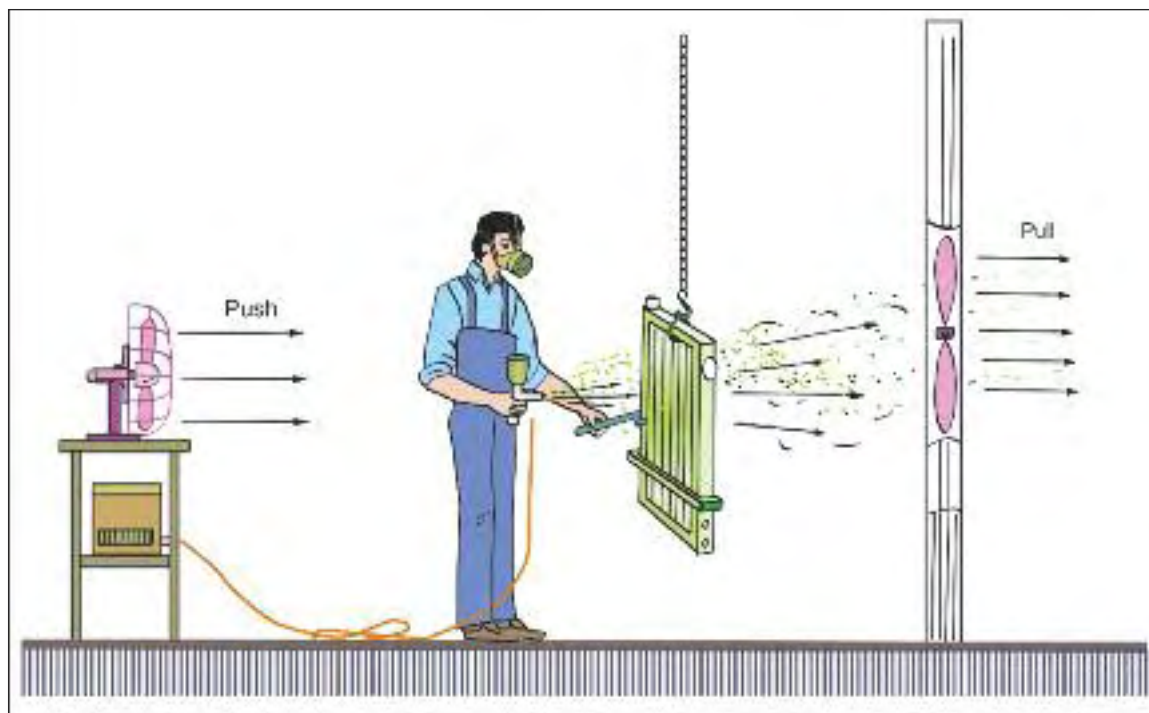

Figure 76b. Push-and-pull ventilation.

CHECKPOINT 77

Increase the use of natural ventilation when needed to improve the indoor climate.

WHY

Natural air flow serves as a very powerful ventilator. Winds bring in fresh air and take away hot and polluted air. Measures to increase natural ventilation are generally recommended, except in very cold weather or in processes unsuited to outside air or to changing air flow.

Before installing costly ventilation systems, an increased use of natural ventilation is an option worthy of consideration. Natural ventilation can be combined with the use of ventilation equipment.

RISKS / SYMPTOMS

- thermal discomfort
- heat stress
- excessive fatigue

HOW

1. Choose a place for work where there is a strong natural air flow, particularly in a hot climate. Avoid doing work in a relatively enclosed corner or in narrow places surrounded by equipment or partitions.
2. Increase openings facing the outside, for example by opening windows and doors or creating new openings. All these help increase natural ventilation.
3. Rearrange equipment if it disturbs the natural air flow and relocate or remove partitions.
4. Provide or relocate windows and openings in higher positions, or use ceiling fans in order to increase the hot air flow directed towards the outside (hot air rises).
5. Establish a practice of opening windows partially or as a whole depending on the weather and winds.

SOME MORE HINTS

- When relying on increased natural ventilation (e.g. in hot climates), it is important to protect the workplace from outside heat. It is equally important to move heat sources to the outside of the workplace and to improve production procedures so as to minimize the need for special ventilation.
- Install machines in a place where hot air can rise and easily escape to the outside.
- Air outlets and inlets provided at the top and bottom of walls help heated air to rise and cool air to come in from the bottom.
- It is also necessary to eliminate or isolate sources of air pollution at the same time as trying to increase natural ventilation.

POINTS TO REMEMBER

Use natural ventilation fully, especially in hot climates, as it carries away hot air and polluting substances.

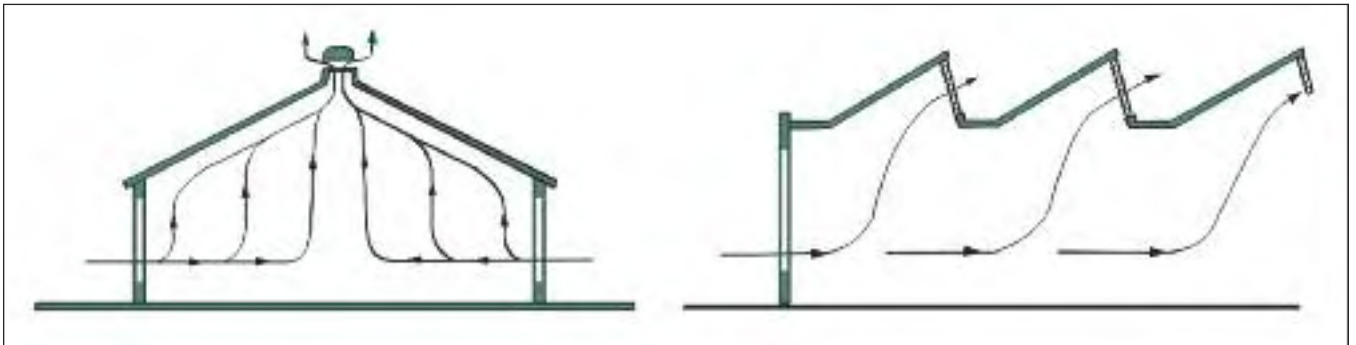

Figure 77a. Air flow routes in buildings of different design.

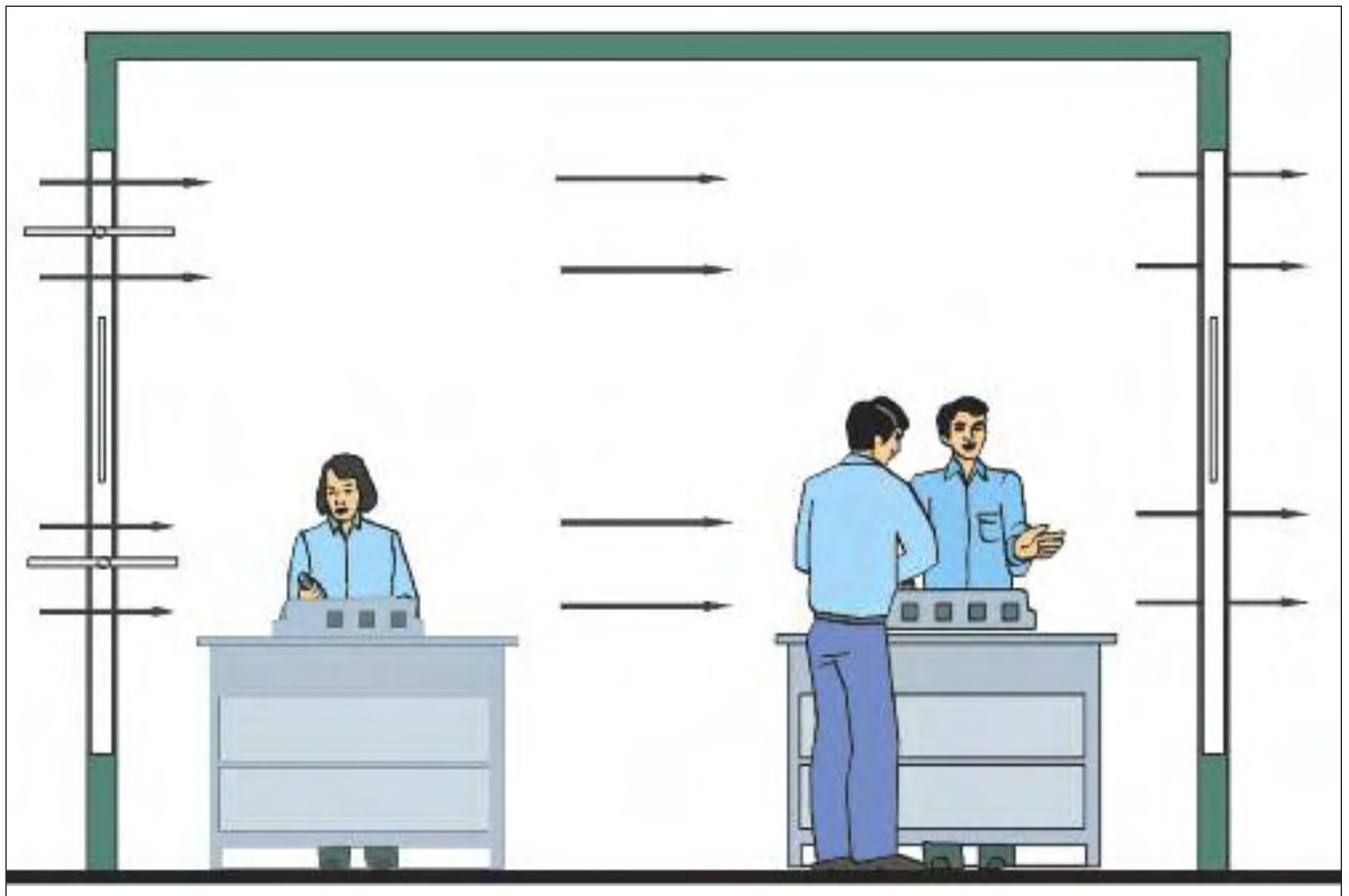

Figure 77b. Natural ventilation from adjustable openings on opposite sides of a room.

CHECKPOINT 78

Use air-conditioning systems to provide an indoor climate conducive to the health and comfort of people.

WHY

Air conditioning usually simultaneously controls temperature, humidity and cleanliness of the air. Work at an adequate range of air temperature and humidity can greatly reduce the disruptive effects of excessively hot or cold environments. Air conditioning is costly, especially in factories, but it is sometimes a worthwhile investment.

By means of air conditioning, the range of air temperature and humidity appropriate for the type of work done can be selected. It is known that air conditioning increases productivity, helps reduce accidents and absenteeism, and improves human relations. The effects on reducing musculoskeletal disorders may also be observed.

Often the effect of cool air flow gives unnecessary chill effects and disturbs work. Adjust the air-conditioning facility carefully to reduce workers' discomfort.

The appropriate air temperature range differs between different seasons. This is because people are differently acclimatized and clothed. The necessary adjustment is more easily done by controlling air conditioning. Attempts are also made to reduce the cost and environmental load of air conditioning.

RISKS / SYMPTOMS

- excessive heat or cold
- thermal discomfort
- upper limb disorder
- stress-induced disorder
- increased injury or illness rates
- poor indoor air quality

HOW

1. Select an appropriate type of air-conditioning system to meet the requirements of the air-conditioned space.
2. In the case of a workspace contaminated with gases, vapours and dusts, take into account their concentrations in using the air-conditioning system.
3. Adjust the system parameters to the comfort of the people in the work space, not to the thermometer readings.
4. Avoid overcooling and uncomfortable draughts. Try to modify the position and parameters of the air-conditioning system and the direction of air flow by listening to the feelings of workers in the air-conditioned space.

SOME MORE HINTS

- Maintain the conditioning equipment in good order, including its element controlling humidity.
- In certain cases, spot-type air conditioning, such as mobile spot coolers, can be used.
- Locate the source of unusual odours. They may originate from particular raw materials or poor quality of waste treatment. Change the materials or waste treatment systems in question, or install an enclosing type exhaust system.
- To improve the efficiency of air conditioning, it sometimes becomes necessary to locate hot machines or processes outside or in a separate room. Careful design of the work space as a whole is useful for increasing the efficiency.

POINTS TO REMEMBER

Careful adjustment of the air-conditioning system functions is needed to increase the comfort of the people in the space.

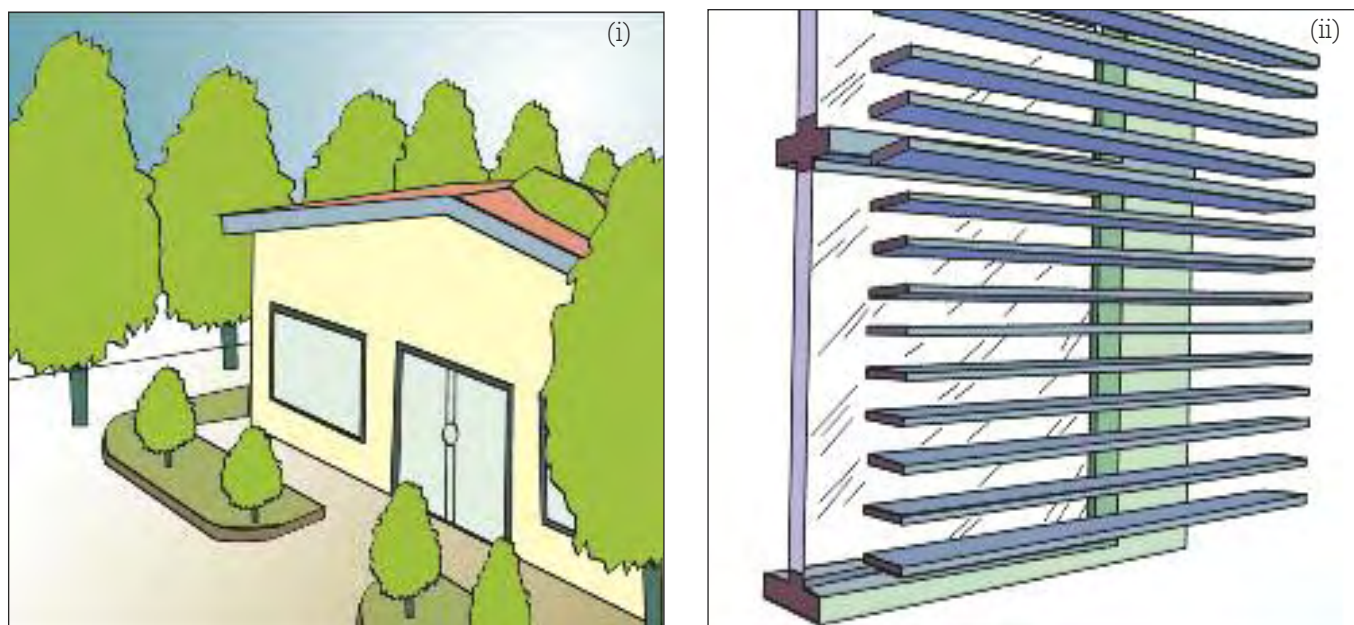

Figure 78a. (i) and (ii) Trees and bushes as well as external screens can help air-conditioning systems function effectively. Protection of the premises from outside heat and cold should first be considered.



Figure 78b. Adjust the air-conditioning systems to the work operations and the preferences of workers. Changing air flow directions can help avoid overcooling of particular groups of workers.

CHECKPOINT 79

Improve and maintain ventilation systems to ensure good workplace air quality.

WHY

Good air flow in a workplace is very important for productive and healthy work. Adequate ventilation can help control hazardous substances and prevent accumulation of heat.

The efficiency of a ventilation system depends not only on its overall capacity but also on how air flow is created and how polluted or heated air is collected. Simple changes in the location of ventilators, electric fans and hoods, or rearrangement of the location of work areas, can often bring about remarkable benefits.

Polluted air is a problem when it is inhaled. Air flow coming from the worker to the polluting sources (and to the outside) greatly helps to reduce this problem. The direction of ventilation must be taken into account.

RISKS / SYMPTOMS

- exposure to hazardous substances
- heat stress
- thermal discomfort
- eye, skin and mucous membrane irritation
- passive smoking
- excessive fatigue

HOW

1. Choose a ventilation system that can effectively ventilate the whole work area for which it is installed. Consult a supplier with good knowledge and experience of such a system.
2. Position ventilation duct inlets and outlets or fans where they are most efficient for the ventilation purpose. Consult ventilation manufacturers or specialists.
3. Use a good combination of push- and pull-type ventilation. Place push ventilation in areas where there is no danger of polluting other places, and use pull ventilation at or near polluted worksites. The capacity of an exhaust pull fan must be 5–15 times larger than that of a push-type fan.

4. Hot air rises, so the use of ceiling fans and windows in higher positions can improve ventilation efficiently. Remember that a chimney has no power source but can ventilate smoke efficiently.
5. Establish a practice of opening windows, as it is a popular and simple way to increase cross-ventilation. Multi-section windows can help to control the air flow according to the wind strength.

SOME MORE HINTS

- When working near pollution or heat sources, the position of the worker should be such that air blows from the worker to the pollution or heat sources (and not in the opposite direction). Avoid air-scattering push-type ventilation towards such sources.
- If installing a good ventilation system for the whole workplace is not realistic (e.g. because of hot machines or strong dust sources), isolate part of the work area by means of partitions and inner roofs, and provide air conditioning for it.
- Do not expect ventilation systems alone to prevent pollution. Take measures to eliminate or isolate the sources of pollution (for example by removing them from the workshop to a place outside under a canopy).
- Maintain ventilation systems by designating individuals or firms in charge of them, and regularly clean floors, walls and machine surfaces appropriately.

POINTS TO REMEMBER

To achieve efficient ventilation, use push- and pull-type ventilation properly. When you work with hazardous chemicals or heated process, an air flow that goes from the worker to the source of pollution or heat is important. Use both common sense and specialist assistance.

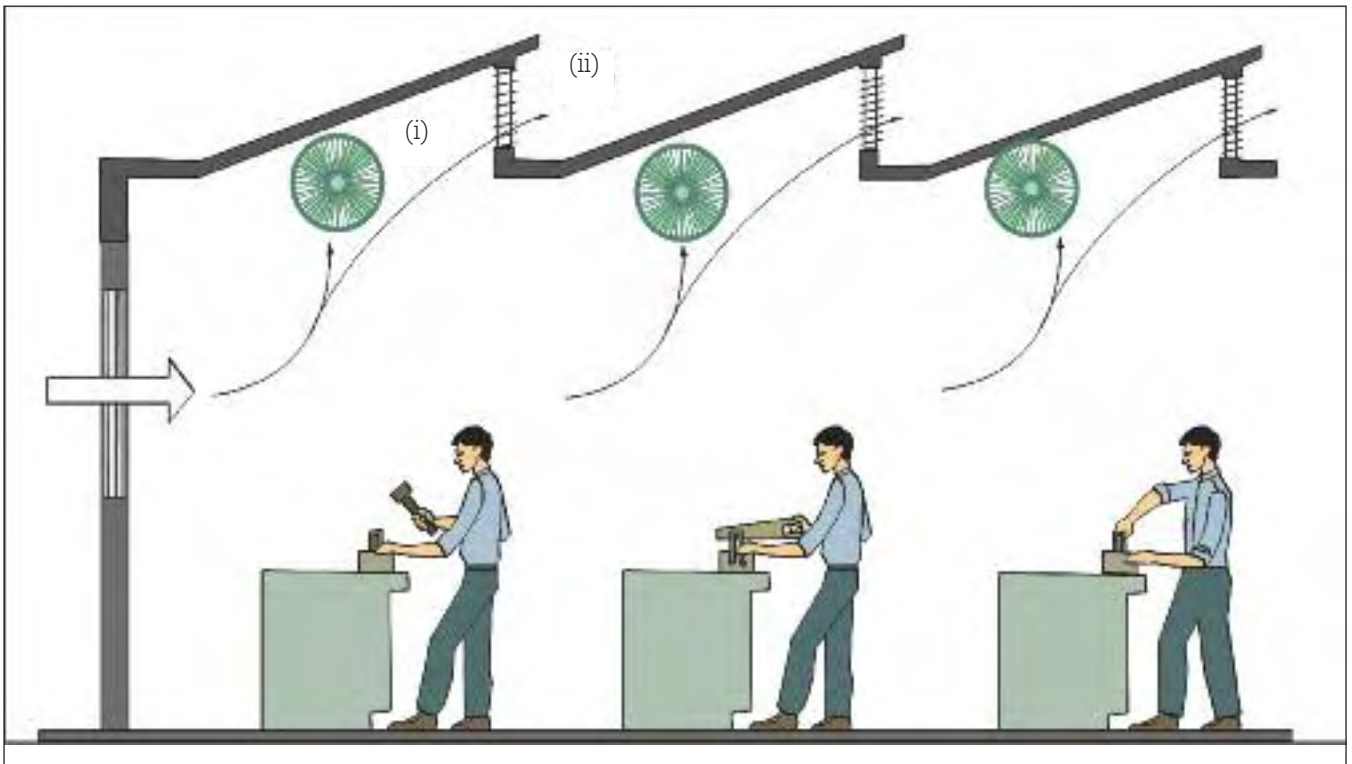

Figure 79. A combined ventilation system. (i) Exhaust fan. (ii) Louvred skylights.

CHECKPOINT 80

Keep the office work area in good order to increase the efficiency and comfort of people using the area.

WHY

A work area should always be well organized and not cluttered with unwanted items. This is particularly necessary in an office workplace because it is used for dealing with varying tasks and often involves people visiting the area from time to time.

Loose items such as computer cables should be tidied, connected in an orderly manner and, where possible, housed in a cable management facility. Cables that are not tidied can cause tripping or accidental pulling of equipment from the work table, causing unnecessary injury to the worker. Rearranged cables help keep order of the office space.

A work area that is well organized creates a pleasant environment for workers and visitors. Clutter can create an eyesore, reduces work efficiency, and can result in injuries if the clutter obstructs smooth work flow.

RISKS / SYMPTOMS

- muscular strain
- slips, trips or stumbles
- eye strain
- upper limb disorder
- stress-induced disorder
- fire

HOW

1. Organize the work area so that unwanted items (e.g. documents, containers, etc.) are stored away or discarded.
2. Store tools in their proper toolboxes or housing facility after use.
3. File away or archive documents that are no longer in use in filing cabinets or archival storage. Do not leave documents and manuals scattered in the work area.
4. Tidy cables and rearrange them in an orderly manner, and where possible, house them in special cable management facilities.
5. Use an integrated power and data access facility in the centre of work tables (e.g. meeting tables) to house and integrate power access points and internet connections.
6. Position fire extinguishers in appropriate places, if appropriate above floor level.

SOME MORE HINTS

- Purchase work tables that have an in-built cable/wire management facility as this is more convenient and the power cables are integrated.
- Train workers in housekeeping rules, and review the workplace from time to time.
- Use labels and colour codes to organize stored or filed items so that they are easily accessible.
- Provide mobile storage or filing cabinets on wheels so that workers can arrange them easily in their workspace.

POINTS TO REMEMBER

Good housekeeping of the office work area is achieved by rearranging office facilities and storage systems. Installing a cable management facility can also help keep order.



Figure 80a. Keep the office work area in good order by arranging easy-to-reach filing systems and computer workstations and by maintaining office machines regularly.

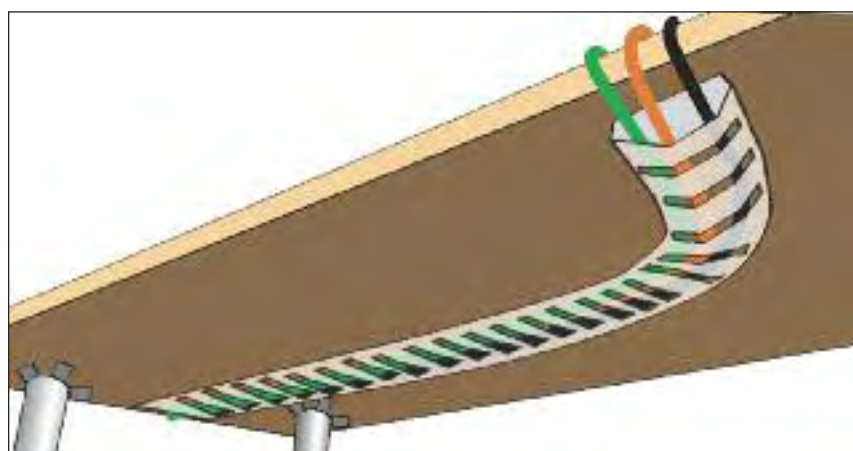

Figure 80b. Rearrange cables in an orderly manner. House them in appropriate cable management facilities.

CHECKPOINT 81

Provide enough fire extinguishers within easy reach and be sure that workers know how to use them.

WHY

Early detection of a small fire and the use of portable fire extinguishers are among the most important fire-protection measures. A sufficient number of fire extinguishers placed in designated areas and clearly marked can greatly reduce the risk of large fires.

Adequately applied fire extinguishers can dramatically quench the flame of fires. It is important to provide adequate types of extinguishers and train workers about how to use them in the case of a fire.

Portable fire extinguishers are effective only in the early stages of a fire. It is necessary to place a sufficient number of extinguishers so that they are easily reached and used as soon as possible.

RISKS / SYMPTOMS

- fire
- exposure to hazardous chemicals
- serious injury or accident
- delayed evacuation

HOW

1. Select appropriate types of portable fire extinguishers. Carefully observe fire safety regulations and the fire department's instructions. Check all the extinguishers placed in and around the workplace. Make sure that people fight a fire with the proper class and type of extinguishers (e.g. Class A for ordinary combustibles; Class B for flammable liquids or gases; Class C for electrical equipment; and Class D for flammable metals).
 - Water extinguishers: in the case of ordinary fires.
 - Multipurpose dry powder extinguishers: in the case of ordinary, oil and electrical fires.
 - Foam extinguishers: ordinary and oil fires.
2. Clearly mark the positions of fire extinguishers. It is often advisable to put them on the wall so that they are visible.

3. Provide a sufficient number of fire extinguishers and place them within about 20 m of every workplace.
4. Train workers in the appropriate use of fire extinguishers. Usually, an extinguisher may be used by pulling the pin, aiming its nozzle at the base of the flames, squeezing the trigger while holding the extinguisher upright and sweeping it from side to side to cover the area on fire.
5. Maintain fire extinguishers regularly. Make sure that pins, nozzles and nameplates are intact and no extinguishers are missing or empty.

SOME MORE HINTS

- Train and retrain all managers and workers regularly in the proper use of fire extinguishers.
- Fire drills should be scheduled and regularly conducted to test the emergency action plan. The plan must be known by all managers and workers, including fire-fighting procedures and evacuation.
- Never fight a fire if it is spreading beyond the spot where it started, or can block your only escape, or if the extinguisher runs out of agent or proves to be ineffective.

POINTS TO REMEMBER

Maintain a sufficient number of fire extinguishers, clearly marked and placed within easy reach. Train workers in how to use them as part of an emergency action plan.



Figure 81a. Provide sufficient fire extinguishers at clearly designated places within work areas.



Figure 81b. Train workers in the appropriate use of fire extinguishers, including necessary maintenance arrangements.

CHECKPOINT 82

Recycle wastes to make better use of resources and protect the environment.

WHY

Simple, practical workplace actions can make a large difference in environmental protection. Recycling of wastes is the first important step for this. Unnecessary parts of raw materials, rejected or broken products and semi-products can be reused for many useful purposes when employers and workers collaborate.

There are many practical ways to recycle wastes. For example, containers prepared for different wastes help workers collect the waste separately. Conveniently placed waste containers near the workplace facilitate workers' proper actions.

Well-organized waste-collecting systems at the workplace will reduce workloads and accident risks of waste-collecting workers. These practices can be established in accordance with workplace safety and health management systems.

RISKS / SYMPTOMS

- environmental damage
- serious injury or accident
- exposure to hazardous substances

HOW

1. Collect different types of workplace wastes separately. Arrange separate waste bins or containers, close to the workplace and with clear labels, depending on the materials. For example, you may collect separately organic wastes such as animal and plant materials, wood materials and metal wastes.
2. Some waste materials such as sharp glass materials or corrosive chemicals are dangerous to both workers and waste collectors. These waste materials need special durable containers and lids with warning signs.
3. Establish a workplace system to reuse or recycle the collected waste materials. Some collected materials, such as metal materials, may be brought back to the production process and reused again as

raw materials. Dangerous wastes such as chemicals may need to be safely transferred to special treatment plants for recycling or safe disposal.

4. Recycle used water. For example, half-dirty water used for washing raw materials may be collected and reused for cleaning floors, unless the water contains hazardous substances. Save water when washing materials. Batch washing methods need less water than rinsing.

SOME MORE HINTS

- Try to minimize the amount of waste. Obtain raw materials that include minimal wastes and minimal unnecessary parts.
- Repair and reuse tools, devices or equipment instead of throwing them away.
- Identify waste materials that are potentially harmful to workers and waste collectors. Establish safe collecting procedures. Seek advice from relevant agencies.
- Provide workers with training and information on practical ways of collecting and recycling wastes. Invite workers' ideas to strengthen recycling activities.

POINTS TO REMEMBER

Separate collection of different types of wastes is the first important step to reusing and recycling them.



Figure 82a. (i) and (ii) Place separate waste containers in the workplace for different types of waste materials such as metals, bottles, cans and plastics.

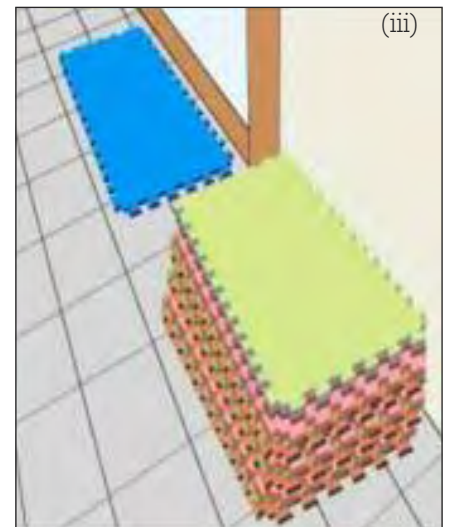

Figure 82b. (i), (ii) and (iii) Develop a mechanism to recycle and reuse separately collected waste materials.

CHECKPOINT 83

Mark escape routes and keep them clear of obstacles.

WHY

It is important to always keep escape routes clear of obstacles.

Escape routes, if rarely used, tend to be neglected and thus become obstructed by piled-up materials, waste or equipment. It is too late to start clearing the escape routes after a fire breaks out.

In an emergency, people get upset and may even panic. Therefore escape routes must be easily recognizable and simple to follow.

RISKS / SYMPTOMS

- delayed evacuation
- slips, trips or stumbles
- serious injury or accident
- pedestrian safety

HOW

1. Make sure that there are at least two exit routes in each work area. Take into account the possibility of a fire breaking out near an exit route. Check legal requirements for escape routes.
2. Mark each escape route on the floor unless it is explicitly clear that it is the escape route (as in the case of fenced aisles or corridors). Clearly indicate the emergency exit with a sign. Where the emergency exits are not immediately visible, clearly signpost the direction of the nearest emergency exit.
3. Firmly establish the practice of placing nothing on escape routes and of keeping them clear of obstacles at all times.
4. Use fences, handrails or screens to create a clear space around the emergency exits and to allow easy access to them. Put fences or handrails along the escape routes when these tend to be obstructed by stacked goods.

SOME MORE HINTS

- Check that escape routes are easy to recognize and follow at all times when workers are present, e.g. during an evening or night shift, or in the case of a sudden power cut.
- Organize evacuation drills at appropriate intervals and use these as an opportunity to ensure that escape routes are free from obstacles. Too frequent evacuation drills, however, can be a problem. Rather, have a designated person (or team) check the escape routes regularly.
- Provide storage shelves, pallets, racks or waste bins near the work areas or passageways where materials and work items tend to pile up. This helps keep the escape routes clear at all times.

POINTS TO REMEMBER

Clear and easily recognizable escape routes can save your life. An emergency can happen at any time.

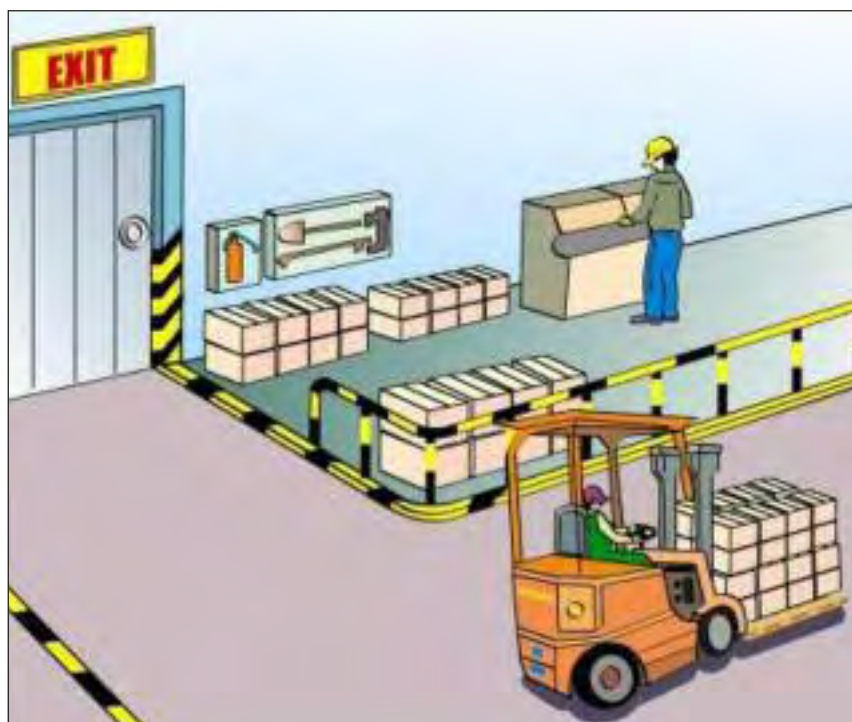

Figure 83a. Mark escape routes and keep them clear of obstacles.



Figure 83b. Cooperation of all workers is necessary to always keep the emergency exit clear of obstacles.

CHECKPOINT 84

Establish evacuation plans to ensure safe and rapid egress from the worksite.

WHY

Evacuation of workplaces becomes necessary more often than many workers realize. It should be remembered that lives may be lost if the evacuation process is not reliable. It is not uncommon for fires or explosions to occur or for accidents to release harmful substances.

By establishing an emergency action plan including evacuation, everyone becomes aware of what to do and how to evacuate the workplace.

The amount of time available to evacuate certainly depends on the nature of the disaster. The evacuation plan must meet the particular needs of every workplace, and all workers and visitors should be instructed in advance how to evacuate in an emergency.

RISKS / SYMPTOMS

- fire or explosion
- exposure to hazardous chemicals
- delayed evacuation
- serious injury or accident

HOW

1. Each workplace should develop an evacuation plan, designate evacuation routes, and inform all workers about what to do in an emergency.
2. Post enough standard signs indicating the direction of evacuation in an easy-to-see and understandable manner.
3. Periodic drills of emergency evacuation should be conducted to ensure that all workers know exactly what to do and any faults are identified.
4. The evacuation plan must make it clear that all persons should walk to the pre-designated assembly location, and that no person should leave the assembly location or return to the worksite until all persons are accounted for and the site is declared to be safe.
5. Display posters of important emergency telephone numbers and names of people in charge around the workplace.

Evacuation procedure

1. Each supervisor should be responsible for the safe and orderly evacuation of all workers in his or her area of responsibility, and should ask workers to report a fire or an accident that could cause an emergency.
2. The head of the evacuation exercise should be contacted immediately to decide whether evacuation proceedings should begin.
3. The supervisors in charge should: (a) direct evacuation by the safest routes; (b) check that all workers have left the department/plant; (c) proceed to the designated assembly area; (d) check personnel/worker numbers; and (e) obey all instructions from the chief supervisors and emergency services.
4. The supervisors should ensure that no person returns to the plant buildings until instructed to do so by chief supervisors on the advice of the emergency services.

The evacuation procedure also includes: contact emergency services (e.g. fire brigade); make a voice announcement to evacuate the building; send staff to predetermined points of assembly; leave all equipment "as is"; and close the building door after the last person.

SOME MORE HINTS

- Evacuation plans should always include a site plan showing designated assembly areas.
- Take into account the special needs of people with disabilities during an evacuation.
- Establish mutual aid arrangements with health-care facilities.
- Keep staff duties according to the emergency action plan printed and posted throughout the workplace for easy reference.

POINTS TO REMEMBER

Establish the evacuation plan and make it known to all, and make sure that escape routes are cleared and marked at all times.

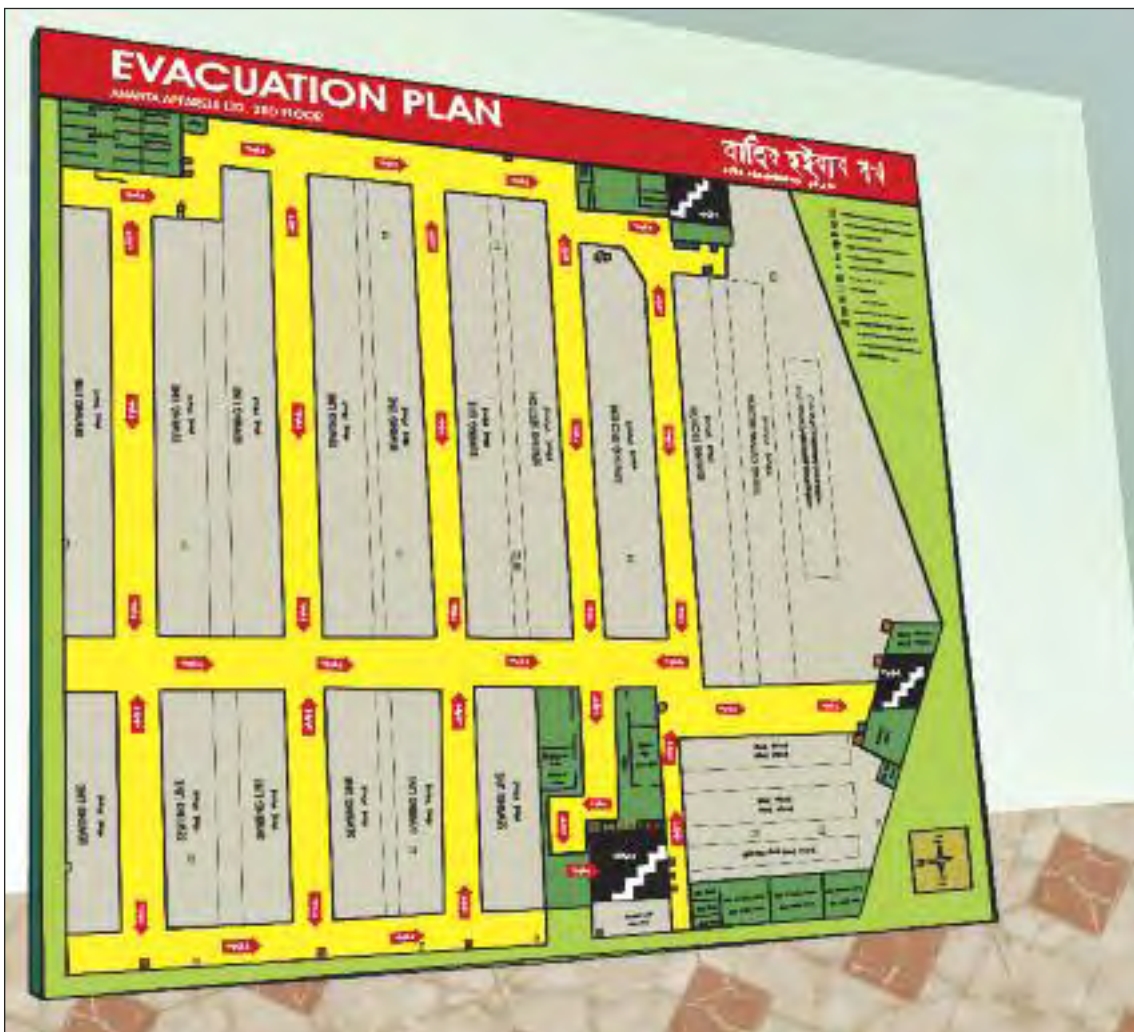

Figure 84. Place evacuation plans and routes on the walls of work areas to ensure quick and safe evacuation in case of an emergency.

Hazardous substances and agents

CHECKPOINT 85

Isolate or cover noisy machines or parts of machines.

WHY

At many workplaces, the level of noise created by machines can be injurious to hearing and can affect the health of workers (a noise level of 85–90 dB(A) or more is harmful to hearing). If you stand at arm's length from your co-worker and cannot communicate in a normal tone of voice, the noise level is too high.

Levels of noise that are too high can cause accidents and affect production, as warning and other signals are not heard.

The best way to reduce noise is to enclose entire machines or particularly noisy parts of machines.

If the noise cannot be reduced at the source, you can still consider isolating the noisy machines away from the places where work is actually done.

RISKS / SYMPTOMS

- hearing loss
- poor communication
- serious injury or accident

HOW

1. Enclose entire machines that produce excessive levels of noise. If this is not possible, enclose particularly noisy parts of machines.
2. If possible, position particularly noisy machines outside the workplace and cover them with appropriate structures.
3. Relocate particularly noisy machines so that they are at a distance from the place where most of the workers are working.
4. Provide screens or partitions to isolate noisy machines from other workers in the same workplace. For a noisy machine, providing a booth that can cover the whole operating site, or ceiling-high partitions, can be quite effective.

5. Provide ear protectors such as ear plugs and earmuffs, and train workers in the proper use of the ear protectors when engineering control of noise at the workplace is not sufficient.

SOME MORE HINTS

- Most machines have particularly noisy moving parts. List such sources of noise and discuss with workers whether these noisy parts can be covered without disturbing their operations.
- Covers of noisy machines must be tight enough. Make sure that these tight covers do not cause overheating inside the cover.
- Screw-on mufflers are effective in reducing the noise from pneumatic exhausts.
- Change any machines that are particularly noisy. Many newer types of machinery are much less noisy.

POINTS TO REMEMBER

If you are unable to speak in a normal tone of voice standing at arm's length from your co-worker, then the noise level is harmful to hearing. Steps must be taken to keep your ears screened from the noise, either by enclosing the noise source or by wearing ear protectors.

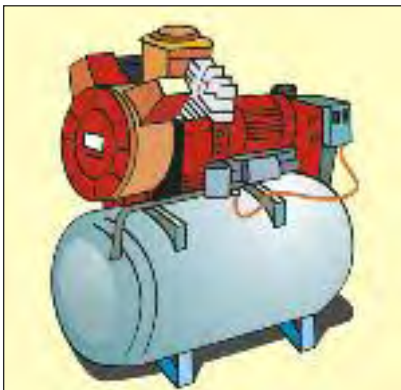

Figure 85a. Noise-insulated air compressors. The principle is that the noise should be contained under the hood. The hood is made of hard material with a soft, absorbent lining.

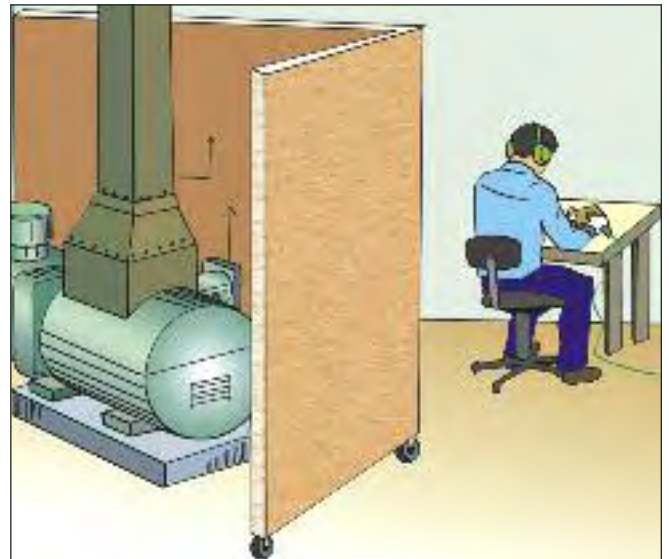

Figure 85c. Protect your ears by enclosing, isolating or covering noisy machines, or by wearing ear protectors.

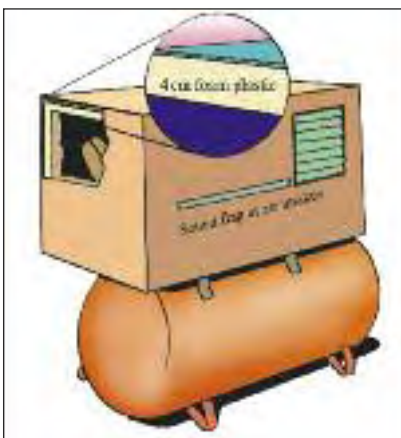

Figure 85b. 1.5 mm stiffened plate reduces vibrations.

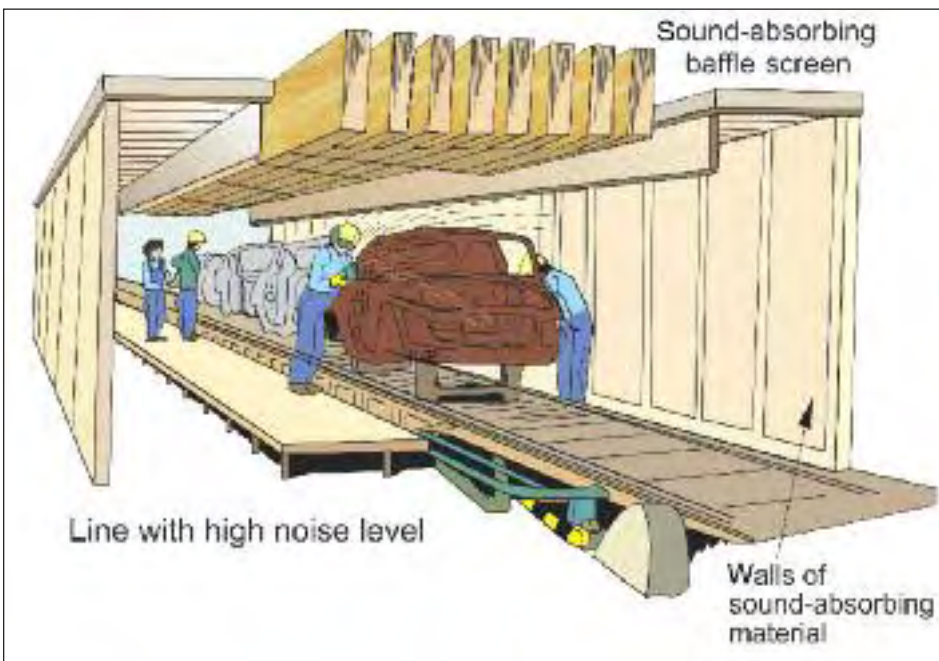

Figure 85d. For noisy production lines, walls of sound-absorbing material and the use of sound-absorbing baffle screens are useful to reduce the noise level and separate the production lines from neighbouring areas in order to prevent the disturbing effects of noise from affecting those areas.

CHECKPOINT 86

Maintain tools and machines regularly in order to reduce noise.

WHY

Often noise levels from tools and machines increase because of poor maintenance or unnecessary vibration. Regular maintenance can greatly help reduce noise levels.

Noise can come from loosely fastened parts or metal parts struck by materials. Such noise can be easily reduced by proper maintenance.

RISKS / SYMPTOMS

- hearing loss
- poor communication
- hand/arm vibration

HOW

1. Establish a rule for servicing tools and machines regularly to keep them in good condition and thereby reduce the noise.
2. Check whether vibrations of certain components of the machine or metal casings are causing unnecessary noise. Maintain these parts properly. For example, make sure that noise-producing parts or casings are properly fastened.
3. Replace metal parts by parts made of sound-absorbing material, e.g. plastic, rubber or other soundproof materials.
4. Cover ceilings and walls with sound-absorbing materials. Also check whether sound-absorbing screens are properly placed.

SOME MORE HINTS

- If appropriate, reduce sharp blows by lengthening the braking period for reciprocating parts or by using rubber or plastic coverings.
- Reduce the unnecessarily high speed of noise-producing power transmission parts or conveyor systems.

- Noise generated when materials hit a chute can be easily reduced by covering the outer surface of the chute with soundproof materials.

POINTS TO REMEMBER

Good maintenance can reduce the amount of noise from tools and machines. Experienced workers can tell you how to keep them in good condition.

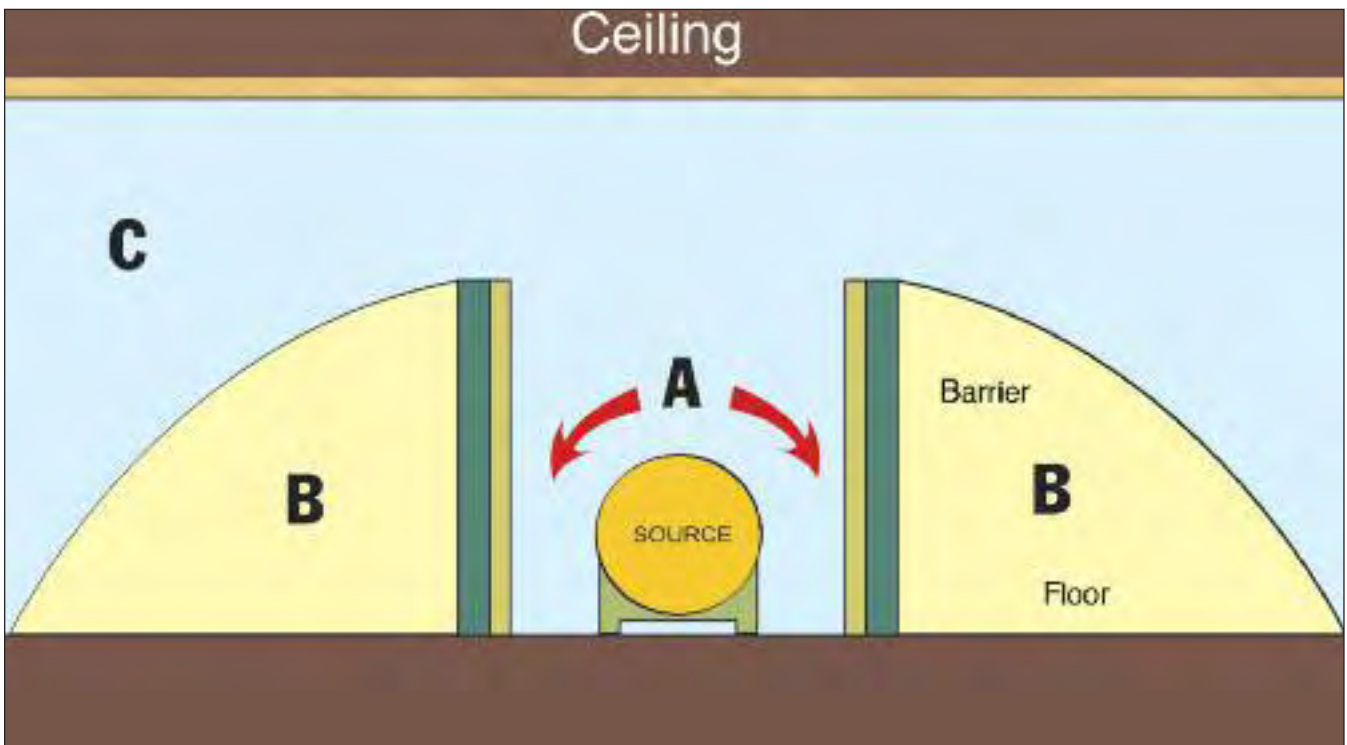

Zone A

Level is increased by reflection from barriers, depending on absorption

Zone B

Shadow for high frequency only

Zone C

Level depends on:
 1. level in zone "A"
 2. size of opening
 3. absorption in room

Figure 86. Check whether sound-absorbing barriers are properly positioned to reduce the noise level at work areas behind the barriers.

CHECKPOINT 87

Make sure that noise does not interfere with verbal communication and auditory signals.

WHY

High levels of noise interfere with warning shouts, signals and communication. This can cause accidents and affect production quality. Communication is particularly important in noisy workshops.

Irritating noise can also disturb work and lead to mistakes. Even a low-volume sound can be distracting. Make sure that even low-level noise does not disturb communication and does not irritate people.

RISKS / SYMPTOMS

- poor communication
- hearing loss
- serious injury or accident

HOW

1. Reduce noise for easy communication and safety.
2. Check with workers whether communication essential for work and necessary warning is impeded by noise. Consider alternative means of communication.
3. Use higher levels of warning signals, or add lamp signals.
4. Provide partitions or noise-proof booths for worksites where communication with others plays an important role.
5. Provide partitions around telecommunications equipment or use better equipment to ensure good communication within the existing noise levels.

SOME MORE HINTS

- Install soundproof material in the ceiling and walls near worksites requiring frequent communication.
- Place light signals near eye height so that they can be seen easily when lit. For warning signals,

however, use acoustic signals that are loud enough, because lights are seen only when workers look in that direction.

- Make sure that workers can hear necessary communication, even when they are using ear protectors.

POINTS TO REMEMBER

Proper means of communication are particularly important in noisy workshops. Use lamp signals if necessary.



Figure 87a. Make sure that necessary communication is not masked by other noises.



Figure 87b. Make sure that ear protectors are effective but do not shut out necessary communication. Emergency light signals and alarms are important means of communication when hearing protection is being used.

CHECKPOINT 88

Reduce vibration affecting workers in order to improve safety, health and work efficiency.

WHY

Many machines or power-driven hand tools transmit their vibrations to the human body. Together with the noise, these vibrations can be harmful. They can injure muscles and joints, and affect blood circulation.

Vibration-induced "white finger disease", seen among workers using pneumatic drills or chainsaws, is a painful example.

Whole-body vibrations of workers on vehicles, cranes or forestry machines are also a problem. They can cause considerable discomfort, difficulty in seeing objects accurately, and even damage to internal organs.

These vibrations are usually difficult to control. But machines are being developed that vibrate far less than before, and there are various inexpensive means of dampening vibrations.

RISKS / SYMPTOMS

- hand-arm vibration
- whole-body vibration
- hand/finger injury

HOW

1. To reduce hand-arm vibrations, purchase equipment with vibration-isolated handles. Study tool specifications before ordering the equipment.
2. To reduce vibrations of existing tools, cover handles with vibration-insulation foam and provide vibration-absorbing gloves. Check with workers whether vibrations have really diminished.
3. In using vibrating tools, avoid continuous vibration and rest the tool on a support or workpiece as much as possible.
4. Reduce the vibration of tools, machines and vehicles by improving maintenance.
5. To reduce whole-body vibrations, isolate the body by better seat suspension, cushions on the seat, etc.

6. Rotate people within a day to reduce exposure to vibration per worker.

SOME MORE HINTS

- Combine the work exposed to vibration with non-vibrating tasks, or insert short breaks.
- Minimize hand-grip force on vibrating tools so far as is consistent with safe working.
- In a cold climate, keep the body and hands warm and dry while using vibrating tools.

POINTS TO REMEMBER

Reduce vibration effects by better engineering and better management. Also improve equipment maintenance.

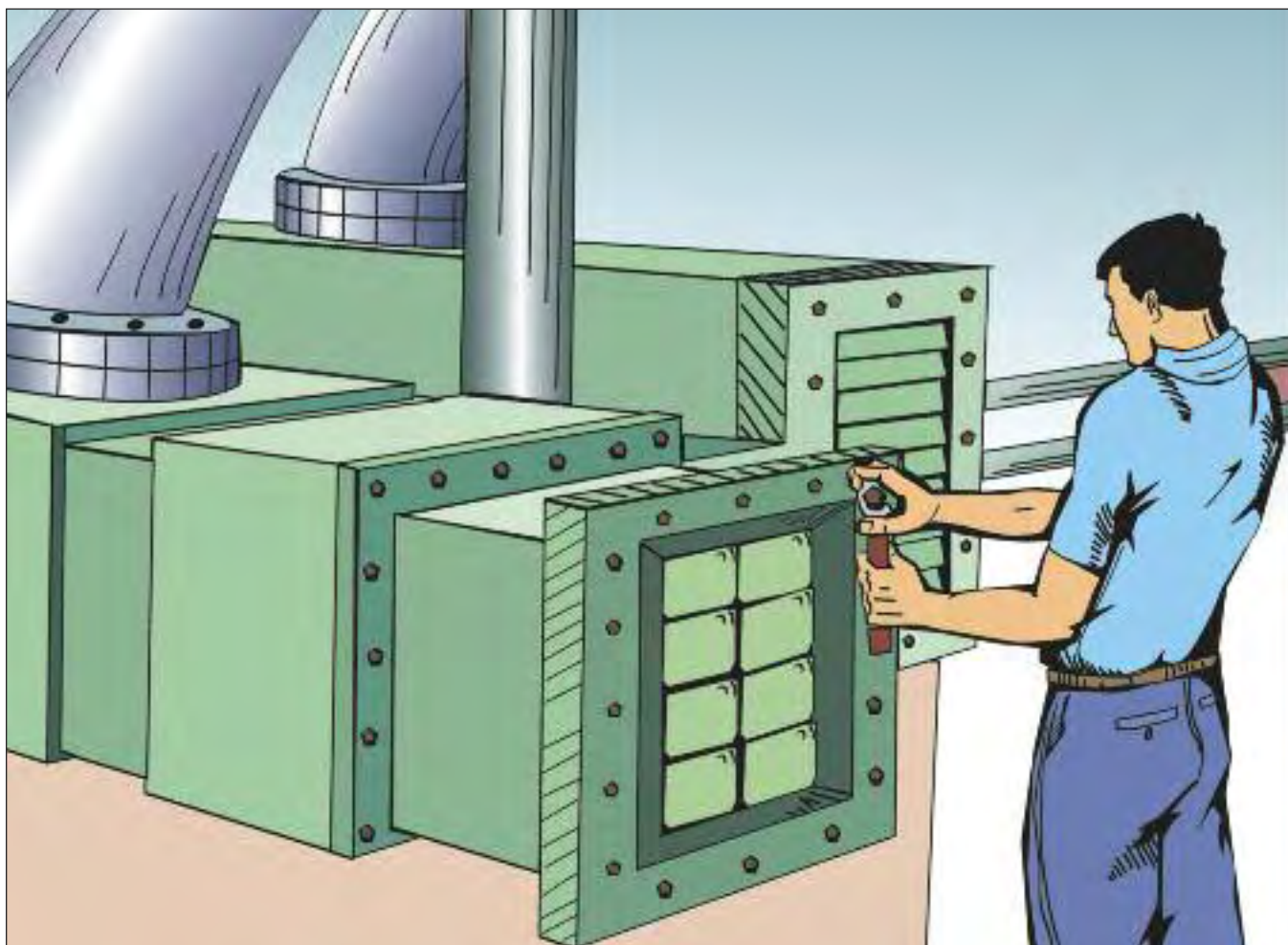

Figure 88. Reduce the vibration of tools and machines by improving their maintenance.

CHECKPOINT 89

Choose electric hand-held equipment that is well insulated against electric shock and heat.

WHY

Although electric hand-held equipment such as lamps are useful for work done while moving from one place to another, they are among the most dangerous portable appliances in any workplace. They are often used in wet and humid places where the risk of electric shock is increased.

Portable electric equipment is used mainly in moving (ambulatory) tasks and in confined locations. The fixtures and cables tend to wear out rapidly, thus increasing the risk of electric shocks.

Unshielded electric hand-held equipment may cause burns and may indirectly lead to stumbling or falling from ladders or scaffolding.

RISKS / SYMPTOMS

- burns
- electrical shock
- electrocution
- slips, trips or stumbles

HOW

1. Select electric hand-held equipment that is well insulated and has steady fixtures and cables made of isolating material, and which are resistant to heat and chafing.
2. Verify before each use that the unit is grounded unless it is safeguarded with a transformer for low-voltage use.
3. Verify that the protective frame around the hand-held equipment is in place and secured, and that the metal grid does not make contact with any metal parts.
4. Arrange regular checking of portable electric devices. Make known to all workers who is responsible for inspection and maintenance.

SOME MORE HINTS

- Use a fixture that has a good protective grid, one side of which is covered with a reflector-shield to prevent glare.
- A portable fluorescent lamp is safer than other lamps in terms of preventing electric shock. It gives more light, which is more evenly distributed.
- Verify that the screw-cap lamp holder is protected so that it is impossible to touch the screw-cap while it is still in contact with the female thread on the holder.
- Provide a home for each item of hand-held equipment to ensure organized storage and maintenance.

POINTS TO REMEMBER

Maintain electric hand-held equipment to prevent electric shock and burns.

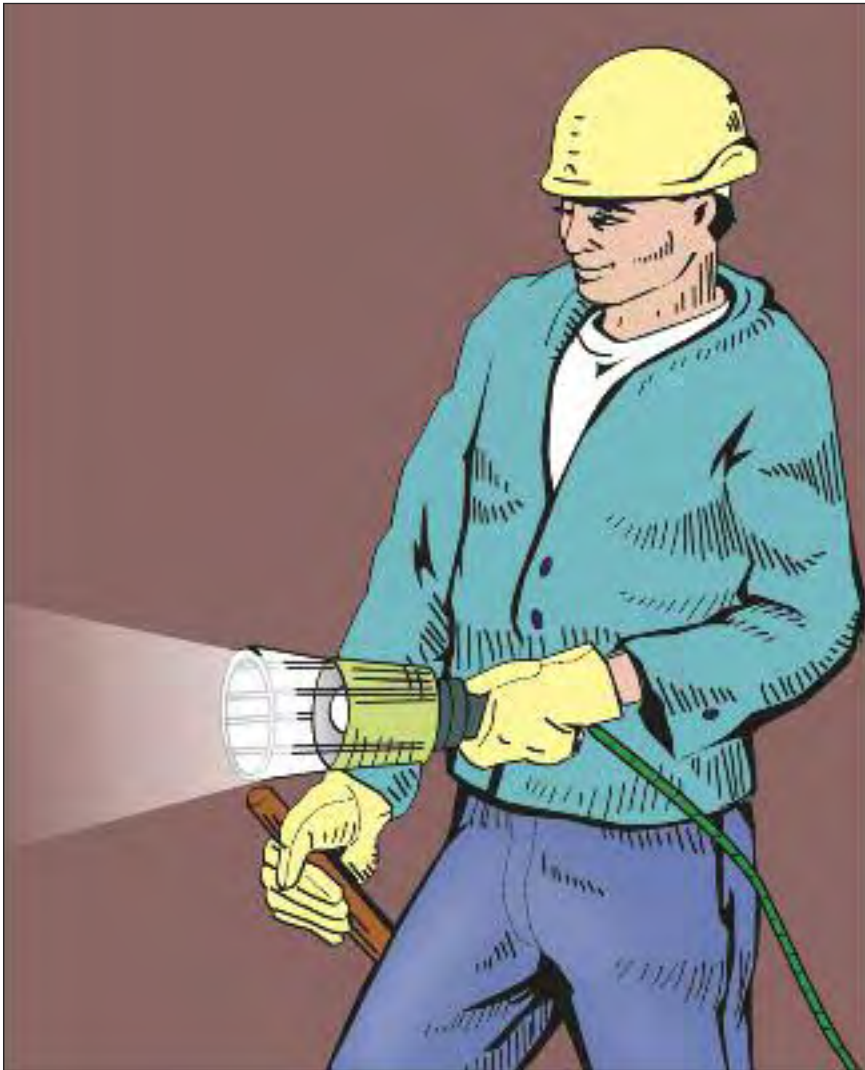

Figure 89. Use hand lamps that are well insulated and have steady fixtures and safe cables.

CHECKPOINT 90

Ensure safe wiring connections for equipment and lights.

WHY

Wiring and light connections are a major source of accidents due to electricity, particularly electric shocks. Special care must be taken to prevent irregular wiring and damage to connections.

Good maintenance of wiring and connections can minimize loss of time and interruptions due to equipment failure. Good maintenance can also reduce electrical accidents.

RISKS / SYMPTOMS

- fire
- electrical shock
- electrocution

HOW

1. Insulate or guard electrical terminals. Ensure that all wirings are appropriate.
2. Provide a sufficient number of socket outlets for wiring connections in order to minimize contacts of workers with cables. If necessary, use an additional multi-plug socket block.
3. Use only prescribed connections and eliminate unauthorized wiring. Never use exposed connections. Inform and train workers about the use of appropriate wire gauges that match the electric power required for machines, equipment and lighting units.
4. Provide proper grounding for machines and equipment, and ensure that power tools and hand lamps in use are grounded.
5. Make it a rule to replace frayed cables quickly. Ensure strict observance of this rule by users of power tools and hand lamps.
6. Train all workers in how to work safely with electric circuits and connections.
7. Protect cables, especially those temporarily placed on the floor, from being stepped on by workers or wheeled over by transport equipment. Place a stable protective cover where there is such a danger.

SOME MORE HINTS

- Protect electric circuits and cables from accidental leakage or spillage of liquids.
- Establish for each workplace a programme of regular inspection of electric circuits and portable electrical equipment.
- Remember that laws and regulations include requirements concerning electric installations. Carefully study them with workers with a view to following them precisely.

POINTS TO REMEMBER

Safe wiring and electrical connections result in less chance of fires and time lost due to machine failures or injury of workers.

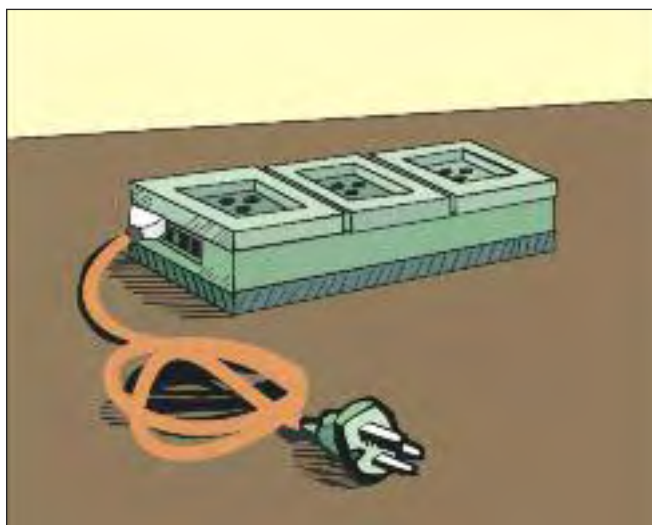

Figure 90a. Safe wiring and electrical connections prevent accidents and fires.

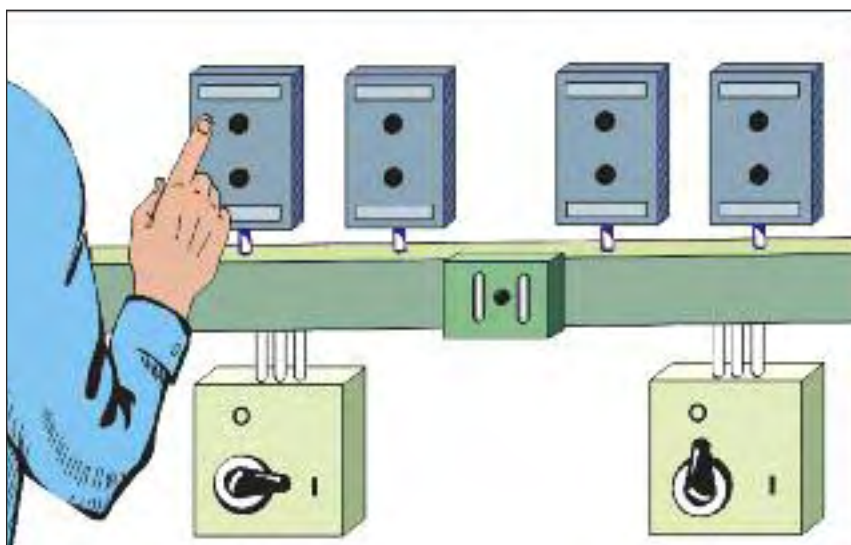

Figure 90b. Keeping wiring and electrical connections well maintained can minimize lost work time due to equipment failure.

CHECKPOINT 91

Label and store properly containers of hazardous chemicals to communicate warnings and to ensure safe handling.

WHY

Labels and signs are used to communicate warnings and other important information regarding the content, use, storage and disposal of hazardous chemicals.

Hazardous chemicals should be separated from each other in storage by distance and partitions or by other appropriate means, so as to preclude accidental contact between them.

Flammable and combustible chemicals should be stored in containers meeting specific standards in non-fire-risk areas indicated by warning signs.

Containers used to store hazardous chemicals that may lead to toxic asphyxiation, suffocation, or anaesthetic effects should not be stored in locations where workers may be exposed.

Work areas using hazardous substances that can be accessed only with permits should be indicated with appropriate warning signs.

RISKS / SYMPTOMS

- exposure to hazardous chemicals
- material spillage
- wrong operation
- fire or explosion
- environmental damage
- large-scale casualties

HOW

1. Label all containers of hazardous chemicals with appropriate signs and warnings that can be understood by users and workers.
2. Provide relevant information on labels, such as common name of product, composition, information on ingredients, instructions for use, care and maintenance, toxicological information, exposure control and personal protection, first aid measures, accidental release measures and shelf life, where appropriate.

3. Ensure that the labels, signs or other forms of warning are legible, and displayed prominently on the containers. Warning signs indicating the dangerous effects of the chemicals should be posted prominently in locations where they are stored or used.
4. Use labels or signs in the preferred language of the users and workers. Educate workers on the labels and signs if the containers and products are not readily understandable in the local language.
5. Store containers of hazardous substances in suitable locations to avoid them being damaged, and make sure the containers are not exposed to heat, which could rupture the containers or cause leakage. Special care must be taken with the containers for inflammable and combustible chemicals and chemicals that may lead to toxic asphyxiation, suffocation or anaesthetic effects.
6. Conduct regular checks of all containers, storage places and hazardous work areas to ensure they are properly labelled and notified.

SOME MORE HINTS

- Obtain or purchase standard labels and signs from appropriate suppliers.
- Use appropriate labelling devices to create legible and clear labels.
- Ensure that the labels and signs comply with safety regulations and standards, including wording and colour.

POINTS TO REMEMBER

Labels indicating hazardous chemicals should be prominently displayed on the containers or locations where they are stored, and should be easily read and understood. In a multicultural work setting, train workers so that they fully understand the universally accepted standard warning signs.



Figure 91a. Use special containers with clear signs and instructions for dealing with hazardous wastes, and establish proper hazardous waste treatment procedures.

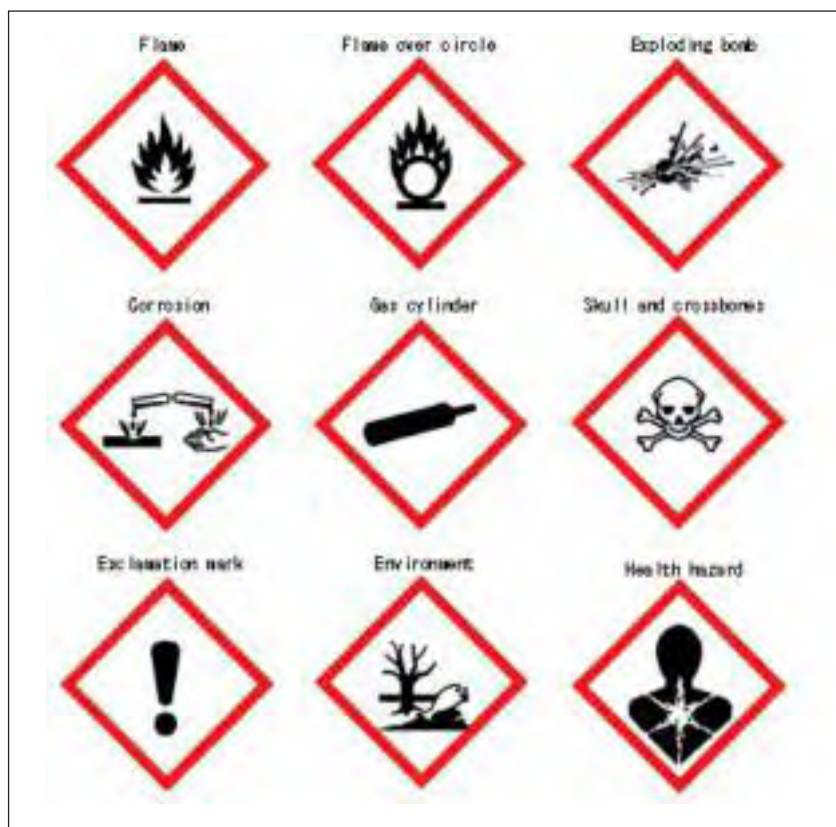

Figure 91b. To label containers of hazardous chemicals, use labels and signs according to the Globally Harmonized System of Classification and Labelling of Chemicals (GHS). (Refer to: http://www.unece.org/trans/danger/publi/ghs/ghs_welcome_e.html)

CHECKPOINT 92

Protect workers from chemical risks so that they can perform their work safely and efficiently.

WHY

Workers can be seriously injured by chemicals such as paints, solvents, cleaners, acids and pesticides. To prevent injury, you must have precise information about the risks and necessary countermeasures.

Exposure to chemicals affects workers' performance and accuracy. Incorrect disposal of chemicals can harm the environment outside the workplace. Necessary precautions must be taken from the entry of the chemicals to the enterprise until their disposal. This should include how they are labelled, used, stored and disposed of.

Many chemicals have long-term effects that are difficult to see. Compensation costs can be very high; prevention is much less costly.

RISKS / SYMPTOMS

- exposure to hazardous chemicals
- material spillage
- wrong operation
- fire or explosion
- environmental damage
- large-scale casualties

HOW

1. Select equipment and processes to minimize chemical risks to workers. Wherever possible use less hazardous chemicals.
2. Label containers of all hazardous chemicals. When the chemicals are transferred to other containers, always remember to label the new ones.
3. Provide each person working with hazardous chemicals with written illustrated instructions. Safety instructions and chemical safety data sheets should be in languages easily understood by the workers and readily accessible at the workplace.
4. Provide training to workers using chemicals. Do not rely only on written materials. Training should include monitoring of health hazards and personal health.
5. If possible, enclose the source of hazardous chemicals so that workers are not exposed to the chemicals, or locate the worksite as far away from the sources as possible.
6. If enclosing the entire process is not possible, use covers, hoods or booths connected to exhaust systems.
7. If needed, provide workers with sufficient personal protective equipment (such as protective clothing, goggles, gloves, respirators and work boots).

SOME MORE HINTS

- Inform workers and management about the latest laws and regulations regarding the use of chemicals in the workplace.
- Use products such as paints, varnishes and adhesives that are water-based rather than solvent-based.
- Total enclosure or local extraction of polluted air needs to be supplemented by increased general ventilation. Check equipment and processes for leaks.
- Use covers with built-in extractors that can be connected to tools and hand-operated machines. For welding, use small ventilation units that either can be connected to an exhaust system or are portable.
- Arrange an air-curtain system for baths of dangerous liquids. The air is blown in under pressure from one side and extracted from the other, thereby screening the worker from the dangerous vapours.

POINTS TO REMEMBER

Certain dangerous chemical risks cannot be detected by human senses. Inform workers of these risks and train them about precautions. Protective measures are much less costly than compensation costs resulting from exposures.



Figure 92a. Noxious fumes can be drawn into a local exhaust system to prevent the worker being exposed to chemical hazards.

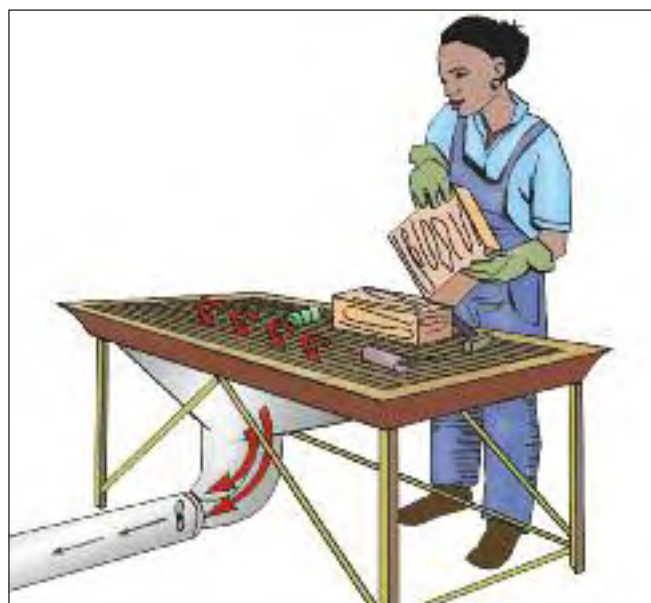

Figure 92b. Drawing contaminants into the work table before they can reach the breathing zone of the worker is another method of local ventilation.

CHECKPOINT 93

Identify confined spaces requiring entry permits and take adequate control measures to render the space safe for entry and work.

WHY

Confined spaces are sites of recurring fatal and serious accidents. Confined structures such as tanks, vessels, pits, sewers, hoppers and others can be very dangerous, as workers entering them are exposed to atmospheric, physical and safety hazards unique to such structures.

As confined spaces exist throughout industry, it is important to make it a rule to allow work in the spaces only for workers obtaining entry permits. Many workers also enter the spaces during construction, inspection, maintenance and rehabilitation. Because this work is mostly non-routine, special precautions must be taken.

The environment inside confined spaces must be checked before entry to avoid very dangerous effects of oxygen deficiency, toxic chemicals and explosives. Precautions should be taken against mechanical, electrical and safety hazards and against heat and cold, noise, radiation, fire as well as personal confinement and engulfment. These conditions need to be assessed by a qualified person, and only trained workers should be allowed to enter the spaces.

RISKS / SYMPTOMS

- oxygen deficiency
- exposure to hazardous chemicals
- aggravated physical effects
- personal confinement
- muscular strain
- stress-induced disorder

HOW

1. Identify confined spaces requiring entry permits and make sure that a qualified person assesses the risks involved and issues entry permits only to trained workers.
2. Monitor the oxygen concentration and the presence of toxic or explosive chemicals inside the confined space and allow entry only when the oxygen concentration is 18 per cent or more and the exposure limits are not exceeded. Sufficient natural or mechanical ventilation must be maintained while working.
3. In spaces where these conditions cannot be met, permit entry only for workers equipped with supplied-air respirators such as air-line respirators, or other protective devices.
4. Take special precautions against potential hazards including physical, chemical, biological, mechanical and other safety and health hazards. Good practices for work in confined spaces should be strictly followed by supervisors and workers.
5. Make it a strict rule to wear designated types of protective equipment inside the space.

SOME MORE HINTS

- Retrain supervisors and workers about necessary precautions at regular intervals.
- Apply only the approved tests in monitoring the concentrations of oxygen, toxic chemicals and explosives inside the space. When using oxygen-consuming devices, ensure that emission gases are completely exhausted and sufficient air is supplied.
- Provide adequate lighting for work inside the space at all times.
- Check and remove industrial wastes that may contain hazardous chemicals.

POINTS TO REMEMBER

Confined spaces are sites of recurring fatal and serious accidents. Strictly apply entry permits to take maximum precautions against oxygen deficiency and various other potential hazards.



Figure 93a. Supply sufficient airflow to confined work areas where oxygen deficiencies may occur before entering there.

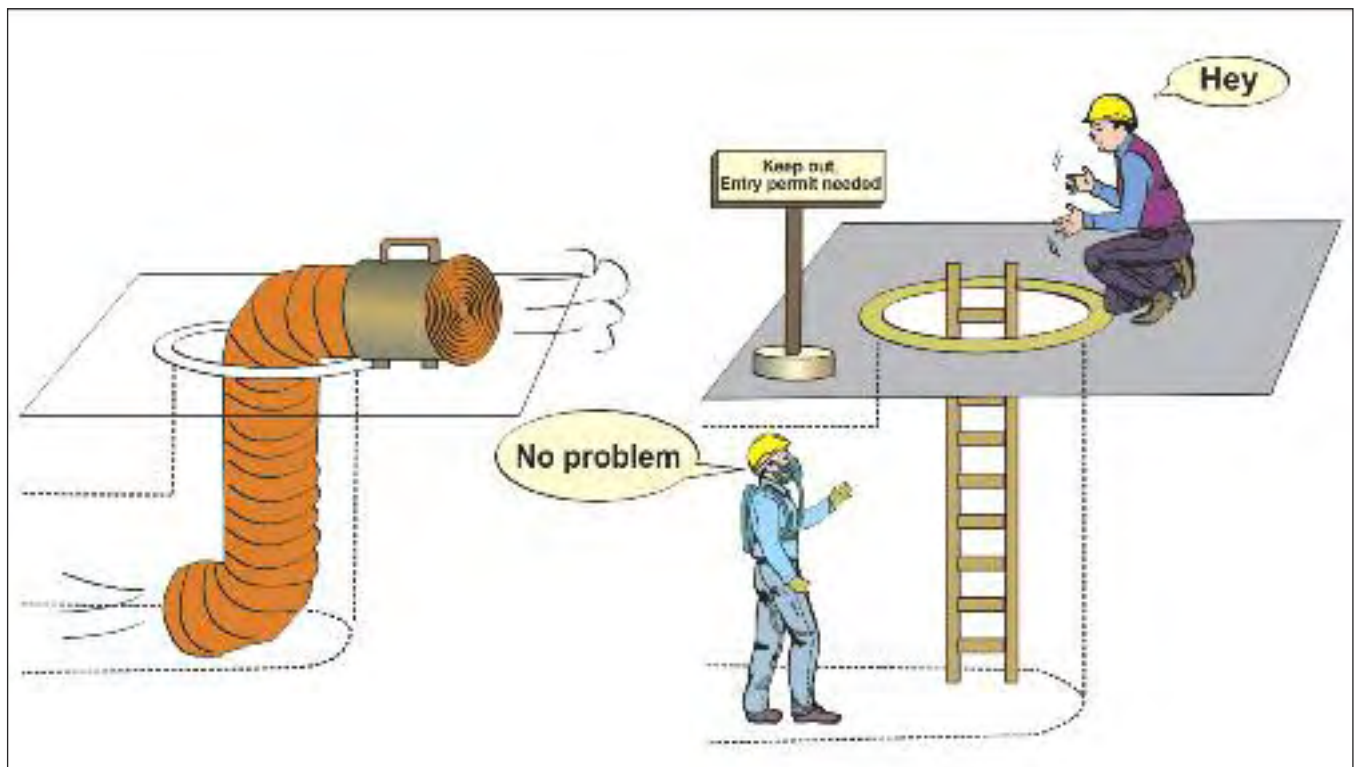

Figure 93b. Before entering a confined space, make sure that oxygen deficiencies and hazardous gases have been checked and control measures taken for workers to work safely inside the space. Sufficient ventilation of the inside air is usually needed. Supervisors and workers need to keep in communication during the work. Rules about wearing designated types of personal protective equipment must be strictly followed when working inside the confined space.

CHECKPOINT 94

Protect workers from biological risks by minimizing exposure to biological agents and isolating potentially contaminated areas.

WHY

When dealing with sources of transmission of biological agents, good work and hygiene practices can protect workers from the risks of exposures to these agents. Training in biosafety procedures is essential in minimizing the risks.

Strict adherence to standard biosafety practices is the most important means of containing biological agents in handling potentially infectious materials. Animal handlers and health-care workers are typical examples. This includes maintaining clean and hygienic conditions, using safety equipment, and working with utmost caution in handling these materials.

In reducing transmission of biological risks during work with potentially contaminated materials, the use of safety equipment and personal protective equipment is recommended.

When there is a danger of a highly contagious disease at work, such as blood-borne pathogens or avian influenza, the risk of transmission can be minimized by taking additional precautions under the guidance of personnel knowledgeable about the particular protection needed.

RISKS / SYMPTOMS

- exposure to biological agents
- infectious disease
- poor worker health
- delay in medical treatment

HOW

1. Identify exposure situations for workers in contact with biologically contaminated materials, body fluids and infectious waste. Workers with biological risks should work under an exposure control plan.
2. Train workers exposed to biological risks in always applying established safety practices.
3. Provide hand-washing facilities accessible for all workers having the potential for exposure to

biological agents. Routinely wash hands before and after work with potential exposures.

4. Provide safe containers for contaminated materials and tools, such as sharps contaminated with blood or body fluids. The containers should be leak-proof, colour-coded and labelled with a biohazard label. Discard immediately into a sharps container after use.
5. Wear gloves when hands are likely to be in contact with blood, body substances or infectious materials.
6. Wear protective clothing, masks and eye protection whenever potential exposure is anticipated. This must be overseen by supervisors responsible for contaminated work areas and protective equipment.
7. Maintain hygiene in workplaces with a risk of transmitting biological agents, such as livestock barns, laboratories and health-care facilities, according to established guidelines.

SOME MORE HINTS

- Discard all infectious waste, including materials contaminated with blood or bodily fluids, into an infectious waste container.
- All personal protective equipment must be removed before leaving the changing room or the work area.
- A written schedule for cleaning and decontamination should be established including locations to be cleaned, cleansers and disinfectants to be used and instructions.
- If exposure possibilities at work are identified for new biological hazards, all the workers concerned require training in work practice controls established by competent persons.

POINTS TO REMEMBER

Principal supervisors at the workplace with potential exposure to biological hazards are responsible for establishing and implementing biosafety practices, use of protective equipment, and training.



Figure 94a. To prevent needle puncture injuries, make it a regular practice to keep used sharps in a safe container placed near where they were used or on a mobile trolley.



Figure 94b. Provide hygienic hand-washing facilities at the worksite. Workers must be trained to wash their hands according to approved methods.



Figure 94c. Maintain hygiene of workplaces with a risk of transmitting biological agents, such as livestock barns, according to established guidelines.

Welfare facilities

CHECKPOINT 95

Provide and maintain good changing, washing and sanitary facilities to ensure good hygiene and tidiness.

WHY

Well-maintained washing facilities, toilets and lockers meet some of workers' most essential needs. These basic facilities, sufficient in number and kept clean and hygienic, represent the "face" of your enterprise.

Washing facilities that are conveniently located help prevent chemicals from being absorbed through the skin or being ingested during snacks and meals. Dirt and grime are unpleasant and may also cause sickness.

Good washing facilities and clean toilets further help to maintain a good working atmosphere.

Facilities for secure storage of clothing and other personal belongings also greatly help to maintain personal hygiene.

RISKS / SYMPTOMS

- poor worker health
- infectious disease
- exposure to hazardous chemicals
- theft or property damage

HOW

1. Check whether washing facilities, toilets, and lockers or changing rooms are far from the worksite, insufficient in number or poorly maintained.
2. Make plans to improve existing facilities with respect to their numbers, convenience of location and design. Keep in mind that many improvements can be made at relatively low cost.
3. Although legal requirements may differ from country to country, the minimum levels that are commonly applied are: one toilet for up to five men and two for six to 40 men; one separate toilet for up to five women and two for six to 30 women; one wash basin for every 15 workers.
4. Provide changing rooms with lockers and showers if work is hot and dirty, requires uniforms or protective clothing, or involves hazardous substances.

5. When workplaces are rearranged or newly built, include good sanitary facilities and changing rooms in the plan. This often proves cheaper in the end.
6. Establish practical arrangements to clean and maintain all these facilities.

SOME MORE HINTS

- Neglect is the main source of problems with sanitary facilities in many workplaces. Give them priority.
- The design of sanitary facilities makes a large difference to the cost and effort required for cleaning. Use floors and walls made of durable materials that are easy to clean (e.g. tiles). Special care should be taken as to proper drainage.
- Lockers should be arranged in such a way that clothes and personal belongings can be kept safe from damage and theft. They should be placed within a special cloakroom area or a changing room, and should preferably be located as far as possible from workstations.

POINTS TO REMEMBER

Essential facilities such as washing facilities, toilets and changing areas or rooms are quite often neglected. Make sure that these facilities serve their purpose and are kept clean. They represent the "face" of your enterprise.



Figure 95a. Arrange for gender-separated changing rooms with lockers and clothes racks allocated to individual workers.

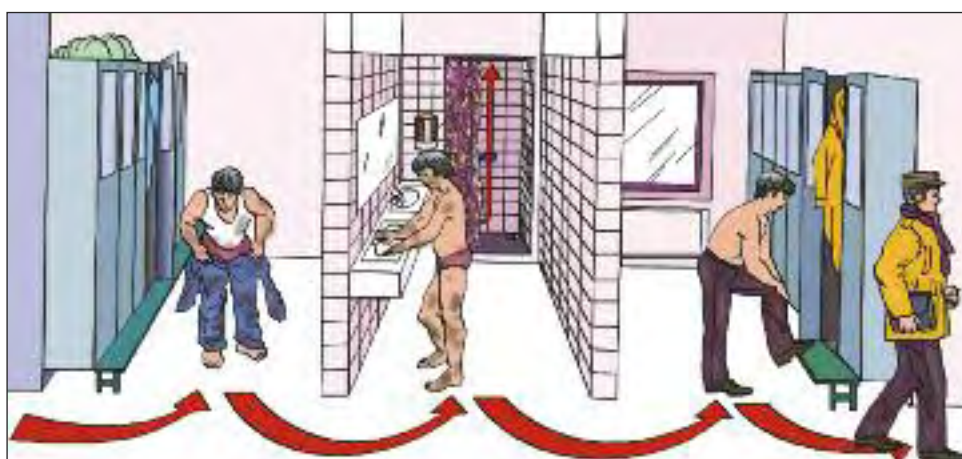

Figure 95b. Personal hygiene is very important in terms of reducing health hazards when using chemical products such as epoxy, isocyanides, lead and pesticides. Do not allow your dirty clothes to spread hazardous substances to your own home and family.



Figure 95c. Providing and maintaining good washing and sanitary facilities is essential to good hygiene and tidiness in the workplace.

CHECKPOINT 96

Provide drinking facilities and hygienic eating areas to ensure good performance and well-being.

WHY

Good drinking facilities and hygienic eating space can do much to prevent fatigue and maintain workers' health.

Workers spend a substantial part of their everyday life at the enterprise. Just as they do at home, they also drink, eat and rest at the workplace. Do not forget that drinking facilities and eating areas are an essential part of your enterprise.

Especially in a hot environment, work results in considerable loss of water. Providing clean drinking water is essential for all types of work.

Private spaces may also need to be provided for breastfeeding where appropriate.

RISKS / SYMPTOMS

- poor worker health
- excessive fatigue
- infectious disease
- exposure to hazardous chemicals

HOW

1. Place water containers near each group of workers, or provide water taps or drinking fountains in a place with easy access (but not near dangerous machines, not in places where water can be contaminated by dust or chemicals, and not in washrooms or toilets).
2. Provide an eating area or room in which workers can eat food in a comfortable, relaxing atmosphere (away from their workstations).
3. Provide eating areas away from workstations and free from disturbances such as noise, dust and chemicals.
4. Maintain hygienic conditions in all these facilities. In an eating space, easy access to clean water for washing, drinking water or other beverages, and rubbish bins is also important.

5. A clean, quiet and private area should be provided for women who are breastfeeding.

SOME MORE HINTS

- It is also important to arrange for the drinking water to be cool. If a water-cooling device is not available, place the water in the coolest place.
- It is advisable to set up the eating area or room in such a way that it can be upgraded to contain some cooking facilities or into a small buffet or canteen as resources become available (e.g. a lunch-room can include a small area where workers can prepare drinks or heat their food).
- There are many different inexpensive ways of providing drinking water and eating areas. Solutions suited to your workplace could be sought by getting feedback from workers.
- The space needed to set up an eating area is often less than you might expect; for 50 workers 25 square metres are sufficient if workers share the space by eating in different sittings.

POINTS TO REMEMBER

Choose types of arrangement suited to your workplace for drinking and eating. This greatly helps to reduce fatigue and maintain productivity and health. Clean and hygienic facilities are appreciated by all workers.

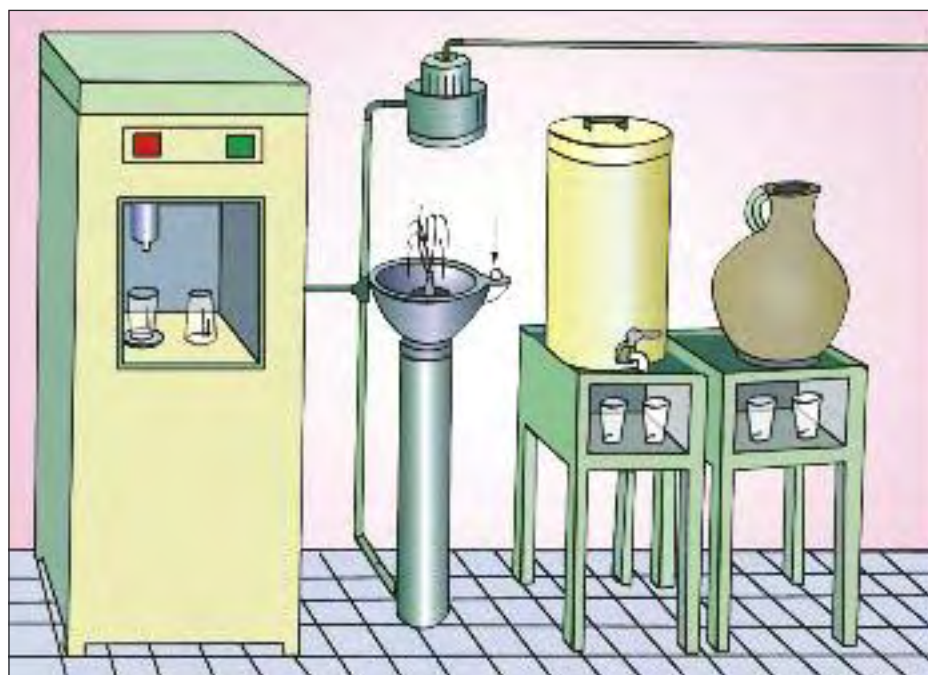

Figure 96a. Ways of providing cool, clean water.



Figure 96b. Provide hygienic eating areas with facilities for refreshments.

CHECKPOINT 97

Provide rest facilities for recovery from fatigue.

WHY

Workers spend a substantial part of their everyday life at the workplace. As at home, they also need to rest, relax and refresh and eat and drink in order to recover from fatigue and maintain good health. Rest corners and facilities separated from work areas are essential.

Getting away from the noisy, polluted or isolated workstation helps workers relax and recover from fatigue, and get ready for continued productive work. Rest facilities should be away from the workstations and free from disturbances.

Comfortable furniture, refreshing drinks and relaxing atmosphere are important for rest facilities for workers. Proper ventilation and green plants are likewise necessary. Toilets and washing facilities should also be conveniently located nearby. The benefits of rest are enhanced when the facilities are arranged in a way that reflects the opinions of workers who use them.

RISKS / SYMPTOMS

- excessive fatigue
- poor worker health
- increased injury or illness rates
- stress-induced disorder

HOW

1. Provide rest corners or rooms separate from work areas and free from disturbances such as noise, dust or chemicals.
2. Provide comfortable furniture and refreshing atmosphere for effective relaxation during rest periods. As a minimum, a table and chairs or sofas are needed, together with clean drinking water and refreshing drinks.
3. Provide hygienic toilets and washing facilities near the rest facilities.
4. Plant trees and flowers in or around rest corners or facilities. Pictures or other decorations on the wall may help create a pleasant environment

SOME MORE HINTS

- Use local and low-cost materials to build a rest facility. A refreshing atmosphere can be created in the rest facility by hearing the opinions of workers who use it.
- A simple canopy outside the factory buildings may provide a shady rest area, especially if there are trees and breezes.
- Clean drinking water and refreshing drinks should be available at rest facilities.

POINTS TO REMEMBER

During rest breaks, workers are not just idle but recovering from fatigue and getting ready for continued productive work. Comfortable rest facilities away from workstations greatly help reduce fatigue.



Figure 97a. A rest area separate from work areas and with a pleasant, restful atmosphere.



Figure 97b. A rest corner with convenient facilities for washing and refreshments.

CHECKPOINT 98

Provide easy access to first-aid equipment and primary healthcare facilities at the workplace.

WHY

First-aid equipment should be organized and provided at the workplace in readiness for injured or unwell workers. Adequate, rapid treatment is essential in the event of injuries due to accidents at work. First-aid facilities and services are more than just a legal requirement; they are an essential part of good working conditions.

Training of qualified first-aiders and preparedness for transport of injured workers are necessary.

Primary healthcare facilities at the workplace can help avoid delays in treating workers suffering from sudden disorders or common diseases.

RISKS / SYMPTOMS

- aggravated injury
- serious injury or accident
- uncontrolled emergency
- delay in medical treatment

HOW

1. Provide first-aid kits in an easily visible place close to work areas. They must be clearly marked and located in places readily accessible in an emergency.
2. Make sure that first-aid kits are stocked with clean and appropriate items. Names of trained first-aiders should be listed close to the kit.
3. A typical basic kit may include the following in a dustproof and waterproof box:
 - individually wrapped sterile adhesive dressings;
 - sterile bandages, pressure bandages, dressings (gauze pads) and slings (including sufficient quantities of the different sizes and medical adhesives);
 - sterile sheets for burns;
 - cotton wool for cleaning wounds;
 - scissors, tweezers (for splinters) and safety pins;
 - an eye bath and eye wash bottle;

- ready-to-use antiseptic solution and cream;
- simple over-the-counter medicines such as aspirin and antacid;
- sterile plastic bags;
- access to ice;
- a booklet giving advice on first-aid treatment.

4. A responsible person should be designated to regularly check the contents of the first-aid kits and replace items that have been used.
5. Primary health-care services should be made available with qualified health personnel. In case the enterprise is too small for such services, several enterprises may be able to establish or contract one together. It is also necessary to keep contact with a nearby clinic or hospital.
6. Identify workers who will be present on each shift interested in training in first aid. Provide training and subsequent refresher training from qualified instructors.

SOME MORE HINTS

- Care should be taken with the provision of medication in the first-aid kits due to the potential for misuse and resultant illness. As a general principle, any medication requiring a doctor's prescription should not be available in the first-aid kit. They could be provided in the healthcare room by a qualified medical officer.
- Provide a record book beside the first-aid kit to record details of the incident or accident resulting in the need for the first aid and the treatment provided.
- An emergency plan for the site should include how an ambulance would obtain access to the workplace to evacuate a seriously ill or injured worker.

POINTS TO REMEMBER

Well equipped and maintained first-aid kits will be of great help for treating workers in an emergency. Access to a nearby clinic or hospital for serious cases is essential.



Figure 98a. A first-aid kit placed on the wall of the workplace and clearly marked.

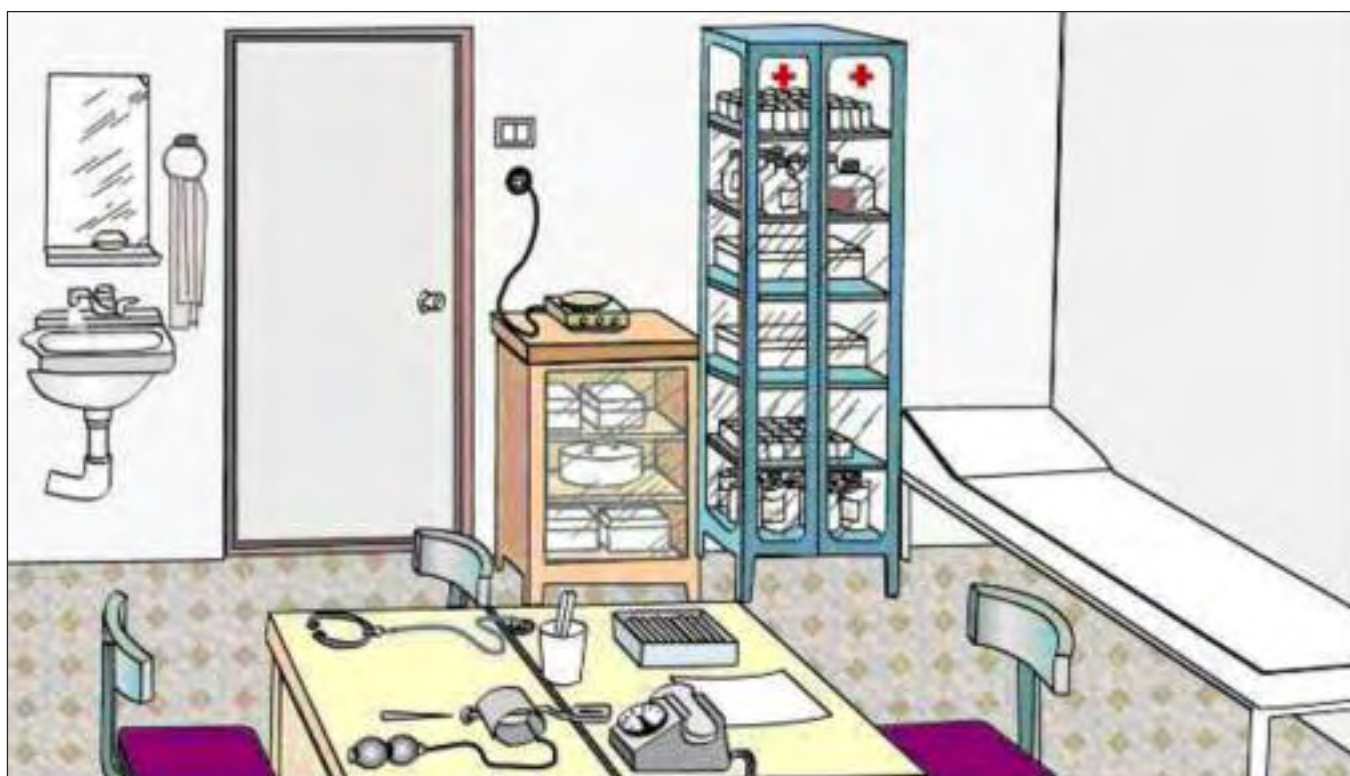

Figure 98b. A factory clinic served by a visiting doctor.

CHECKPOINT 99

Provide a place for workers' meetings and training.

WHY

A good place for workers to meet and receive training will allow them to exchange ideas that are important to the enterprise's success and to the workers' safety and health.

Having an area set aside for meetings and training helps people to take their minds off work and allows them to focus on learning and problem-solving.

RISKS / SYMPTOMS

- poor communication
- poor understanding
- serious injury or accident
- poor worker health

HOW

1. Choose an area that helps to achieve the goals of the meeting or training. The area should be free from distractions and have a low noise level that allows easy listening.
2. Make sure that the place for meetings and training has enough furniture and adequate space so that people can be comfortable.
3. Provide good ventilation and lighting.
4. Control the use of this space so that meetings and training have priority. If it can be moved because of another event, your meeting or training will not seem so important.
5. Provide reading materials (including safety materials) and multimedia equipment and resources.

SOME MORE HINTS

- Consider using a meeting place where people want to be. A pleasant spot will motivate people to come and participate.

- Positive experiences in a good meeting place make people eager to return.
- Enterprises that are close to each other can collaborate to arrange for a good meeting place for their workers.

POINTS TO REMEMBER

If a meeting or training is important enough for workers to take time off from their work, then it should be held in a place where people feel that worthwhile things will happen.



Figure 99a. Provide a place for meetings and training with enough space and furniture for workers to feel comfortable.



Figure 99b. Provide facilities for workers to get together informally, where they can be comfortable and relax.

CHECKPOINT 100

Clearly mark areas requiring the use of personal protective equipment.

WHY

Marking areas requiring the use of protective equipment will help to create a habit of using the equipment. Marking the areas eradicates any doubts in the mind of workers as to whether personal protective equipment is needed or not.

Clearly marked areas where personal protective equipment should be used stress the need to do so. They make it easier for supervisors and workers to maintain the practice of using it without any ambiguity.

RISKS / SYMPTOMS

- exposure to hazardous chemicals
- aggravated physical effects
- increased injury rates
- poor worker health

HOW

1. Identify work areas in which personal protective equipment is required to protect workers from specific hazards.
2. Obtain the type of personal protective equipment designed to protect against such workplace hazards and make it available to all workers who require it.
3. At each such work area, post signs with pictures explaining the type of personal protective equipment needed in that area.
4. Supervise and check the proper use of personal protective equipment in each of the designated areas. Organize regular inspection of these areas by a safety inspection team.

SOME MORE HINTS

- Manufacturers of personal protective equipment are the best source for obtaining signs.

- If a certain piece of equipment requires the use of personal protective equipment, try to install the sign on the equipment (for example, "EYE PROTECTION REQUIRED" on a grinding machine).
- Ensure that the personal protective equipment required in each work area is available in that area.

POINTS TO REMEMBER

Clearly marked areas requiring the use of personal protective equipment will help workers to remember to use their protective equipment all the time.



Figure 100. Clearly mark areas where the use of particular personal protective equipment is obligatory.

CHECKPOINT 101

Provide personal protective equipment that gives adequate protection.

WHY

Although every attempt should be made to eliminate workplace hazards by modifying machines and work methods, there are often situations where the use of personal protective equipment is essential. For hazards that cannot be eliminated, proper personal protective equipment must be selected and used.

Personal protective equipment that provides protection for a certain part of the body (e.g. hand protection or respiratory protection) comes in different types. Each type of personal protective equipment is designed to protect against certain hazards only.

It is imperative to match the personal protective equipment to each type of hazard that may be encountered in each work area.

Using the wrong kind of protective equipment gives the worker a false sense of security. This is very dangerous. It is also very important to select equipment that provides not only the best protection but also good comfort, enables mobility of the worker, and is easy to maintain.

RISKS / SYMPTOMS

- serious injury or accident
- exposure to hazardous chemicals
- aggravated physical effects
- poor worker health

HOW

1. Identify the type of hazard in each work area.
2. Consult the manufacturers of personal protective equipment to ensure that you have the right kind of equipment for protection against the type of hazard in each work area. Designate one person or a team responsible for selection of personal protective equipment, and provide adequate training.
3. Provide a sufficient quantity of the right kind of personal protective equipment for each of the work areas requiring it.

4. Check regularly the proper use of the right kind of personal protective equipment.
5. Ensure that the equipment is properly maintained and replaced when required.

SOME MORE HINTS

- When personal protective equipment is used for protection against chemical hazards, it is imperative to identify the chemicals.
- Although the general term "glove" is used to identify all types of hand protection equipment, it does not mean that any glove would provide protection against all chemicals. For example, a glove designed to protect hands against sodium hydroxide (caustic) may be inadequate for protection against solvents.
- There are no respirators that can protect workers from all chemicals. For example, an air-purifying respirator designed to remove hydrogen sulphide from the air would be worthless against carbon monoxide. A worker using this type of respirator while working with carbon monoxide would have a false sense of security.
- In situations where oxygen may be limited (in a confined space), a filter-type respirator is dangerous. A unit that supplies breathing air to the worker becomes an essential part of the worker's protective equipment.
- Working in hot environments may result in the worker sweating whilst wearing the protective equipment, resulting in discomfort. The selection of the equipment should minimize this feature.

POINTS TO REMEMBER

Avoid using the wrong kind of personal protective equipment that would cause a false sense of security. Consult the manufacturer for any selection and use of personal protective equipment.

Figure 101a.
Make sure that
the chosen
personal
protective
equipment
gives adequate
protection.



Figure 101b. (i) and (ii) It is extremely important to match the personal protective equipment to the particular type of hazard encountered in each work area. Check its proper use regularly.



Figure 101c. Fitting the personal protective equipment to each individual worker is absolutely essential. Make sure that well-fitted equipment is provided and used.



Figure 101d. Give high priority to workers' comfort and easy maintenance in selecting personal protective equipment from among available types.

CHECKPOINT 102

Ensure regular use of personal protective equipment by proper instructions, adaptation trials and training.

WHY

When the use of protective equipment is essential, its regular use is vital.

Even the best protective equipment will not protect workers if it is worn incorrectly.

Only regular use of personal protective equipment can effectively reduce exposure to hazardous conditions and protect workers in the long run.

RISKS / SYMPTOMS

- serious injury or accident
- exposure to hazardous chemicals
- aggravated physical effects
- poor worker health

HOW

1. Training in protective equipment should inform every worker requiring personal protective equipment, both by the spoken word and in writing, about:
 - why it is necessary to use the personal protective equipment;
 - when and where the personal protective equipment should be used;
 - how it should be used; and
 - how to care for the equipment.
2. Train workers sufficiently in the correct use and maintenance of their protective equipment.
3. Encourage workers to use their protective equipment for a trial adaptation period. Bear in mind that the user needs to have time to adapt to it during a supervised trial period of at least several weeks.
4. Supervise and check regularly the use and maintenance of protective equipment at work.
5. Provide spare parts and maintenance facilities at work for quick replacement of worn-out parts or equipment.

SOME MORE HINTS

- Regular use of personal protective equipment is ensured only when it is insisted on all the time and is checked regularly.
- Protective equipment makes an additional work demand. Encouragement and trials are always needed for its proper use.
- For respiratory protection, it is important to inform workers about what types of equipment and what types of filter should be used for their protection.

POINTS TO REMEMBER

Regular use of personal protective equipment at work saves money and reduces human suffering.

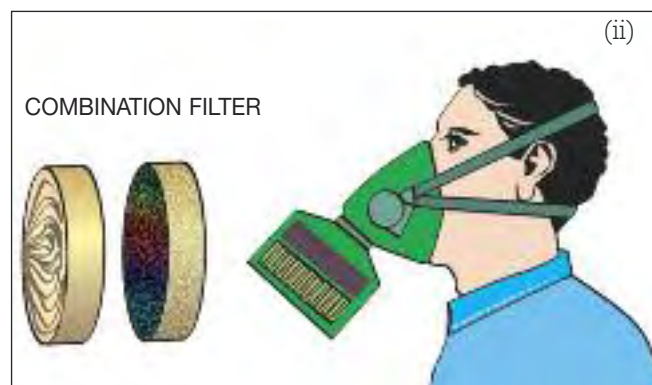
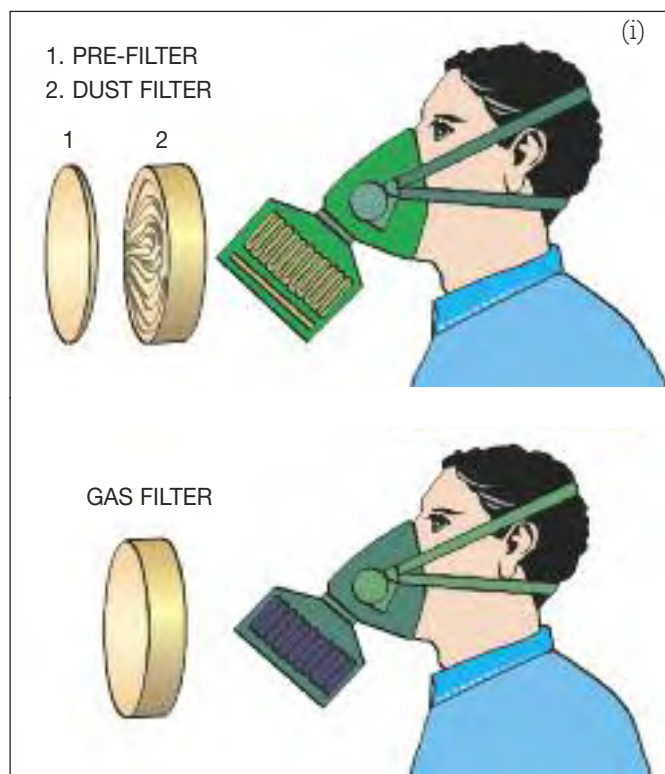

Figure 102a. (i) and (ii) Three types of half mask with filter.

Top left: As protection against airborne particles, e.g. stone dust.

Bottom left: As protection against gases and fumes, e.g. when using paints containing solvents. This filter contains activated carbon.

Above: With a combination filter containing both a dust and a gas filter. These masks are examples of the simplest effective respiratory protection. Replace the filter when it gets harder to breathe or when it begins to smell. Replace the filter frequently.



Figure 102b. All workers who may need to use respirators should be regularly trained in their use, care and maintenance.

CHECKPOINT 103

Make sure that everyone uses personal protective equipment where it is needed.

WHY

Even the best personal protective equipment cannot protect workers against workplace hazards unless it is properly worn.

Workplace hazards do not cause death, injuries and illnesses every day. This gives workers the false assurance that personal protective equipment is not needed. A special training effort is essential.

RISKS / SYMPTOMS

- serious injury or accident
- exposure to hazardous chemicals
- aggravated physical effects

HOW

1. Train workers in the hazards of their work environment and necessary protection against them.
2. Explain to workers how personal protective equipment can protect them against those hazards, and how it fails to protect them when improperly used.
3. Remind workers of the risks they will be taking by not using their personal protective equipment.
4. Give encouragement for proper use of protective equipment and, where necessary, discipline workers who fail to use it.
5. Form a safety inspection team to walk regularly through different work areas and identify unsafe conditions, including situations where personal protective equipment is needed but not used.

SOME MORE HINTS

- Both managers and workers should identify workplace hazards and situations where personal protective equipment is required.

- To convince workers to use their protective equipment, it is essential to obtain the appropriate types of equipment.
- The safety inspection team must include both workers and management representatives.
- Be sure that the safety inspection team takes immediate corrective action and makes a written record of unsafe situations.
- Be aware that workers can develop a false sense of security. Make sure that they do not establish unsafe work habits because they rely on their protective equipment.

POINTS TO REMEMBER

Convince people to use their personal protective equipment properly at all times when it is needed. This needs consistent management.

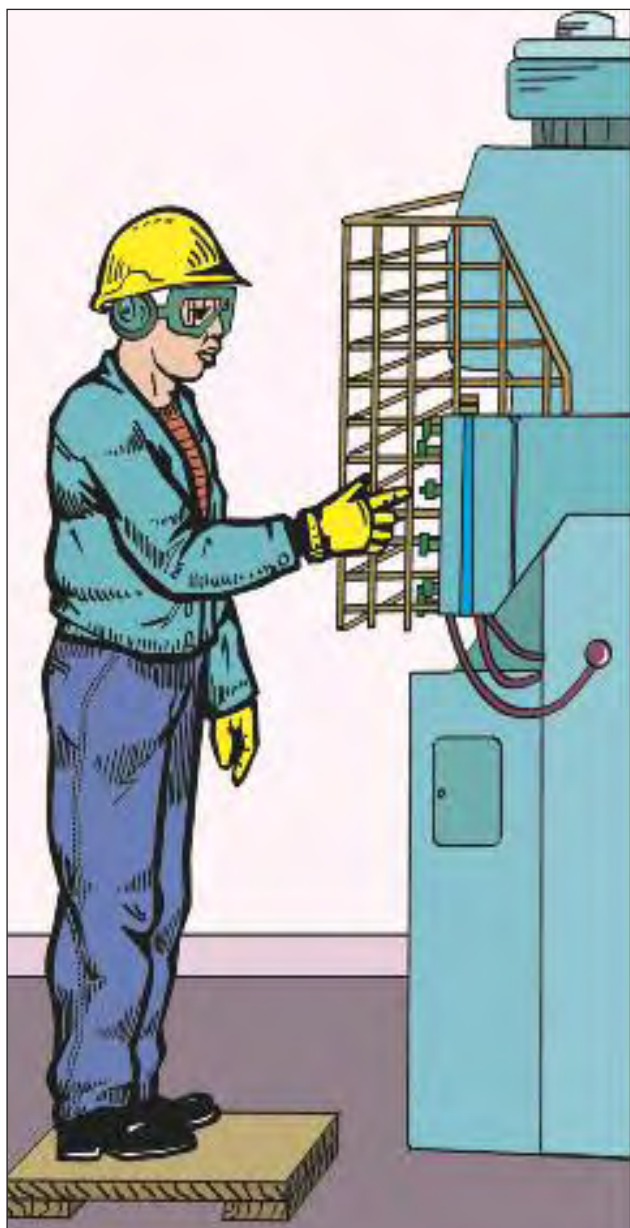

Figure 103a. Encourage workers to use personal protective equipment properly. This must be done in parallel with the enterprise effort to improve workplace conditions in general.

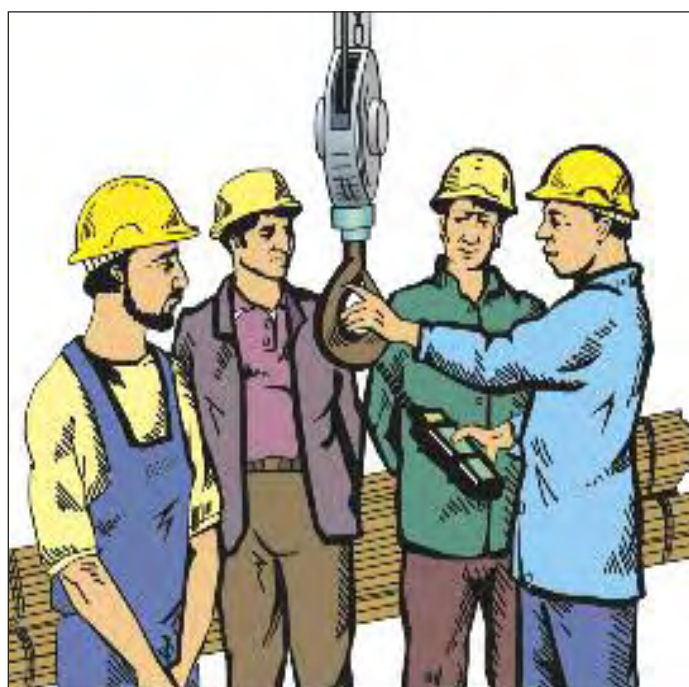

Figure 103b. Both the manager or supervisor and the workers should identify workplace hazards and situations where personal protective equipment is required.

CHECKPOINT 104

Make sure that personal protective equipment is acceptable to workers and that it is cleaned and maintained.

WHY

If personal protective equipment is acceptable to the workers, its regular use is ensured, minimizing the risk of accidents and injuries.

Protective equipment keeps its effectiveness when it is regularly cleaned and maintained.

There are requirements for acceptable personal protective equipment. Take sufficient care to ensure that the invested resources are properly used.

RISKS / SYMPTOMS

- serious injury or accident
- exposure to hazardous chemicals
- aggravated physical effects
- hearing loss
- poor worker health

HOW

1. Provide not only the right kind of personal protective equipment, but also types and sizes to fit each worker. Too tight or too loose equipment, for example, does not protect effectively, causes discomfort, and discourages the user from regular use.
2. Provide users of personal protective equipment with sufficient information about the risk factors at work and the equipment's potential for protection.
3. Make sure that everyone (supervisors, workers, worksite visitors, etc.) uses designated protective equipment where it is required.
4. Always select comfortable personal protective equipment, for example lightweight equipment with proper ventilation and with maximum protection.
5. Designate a person responsible for the maintenance of the protective equipment.

6. Identify how each kind of protective equipment should be stored, cleaned and maintained. Make this known to workers.
7. Make sure that spare parts are available for the protective equipment to ensure it can be maintained effectively.

SOME MORE HINTS

- Adaptation trials before regular use of personal protective equipment are helpful to convince workers that the equipment is necessary and acceptable.
- Consider workers' preferences regarding the colour, shape, material and design of the protective equipment.
- Where respiratory protectors are worn, provide spare filters and instruct workers on the replacement requirements.

POINTS TO REMEMBER

Personal protective equipment that is acceptable to workers is used more willingly and regularly. Monitor any non-use of the protective equipment and determine a process to address any problems the workers may be having with its use.



Figure 104a. Always select comfortable and well-fitting personal protective equipment.



Figure 104b. Personal protective equipment is developing fast. Always select equipment that is effective and comfortable, for example lightweight equipment with proper ventilation and with maximum protection.

CHECKPOINT 105

Provide proper storage for personal protective equipment.

WHY

Good management is the key to a sustainable programme for the use of any personal protective equipment. This should include a good storage policy.

Proper use and maintenance of personal protective equipment is facilitated by providing a "home" for each item. Workers feel responsible for the appropriate use of protective equipment when storing it in a proper place after its use.

Clean and properly maintained personal protective equipment encourages workers to use it regularly. Cleaning of equipment should be incorporated within the maintenance programme.

Simply instructing workers to clean and maintain their protective equipment is not sufficient. Provide good and well-planned support so that workers can cooperate easily in maintaining their own equipment.

RISKS / SYMPTOMS

- serious injury or accident
- exposure to hazardous chemicals
- aggravated physical effects
- equipment damage

HOW

1. Check the number, size and quality of all the necessary personal protective equipment, and establish a policy on where and how to store each item.
2. Maintain records of the protective equipment and spare parts.
3. In consultation with users, designate an appropriate storage place for each item of protective equipment. Make sure that access to the equipment and its inventory are easy.
4. Make a concrete plan for regular checking of the use and maintenance of personal protective equipment. This will be facilitated by the fact that each item has its own place.
5. Maintain the storage place of personal protective equipment in good order.
6. Involve the users fully in all procedures from (1) to (4), above.
7. Good storage procedures should be an important part of the training programme concerning personal protective equipment.

SOME MORE HINTS

- Designation of storage places for personal protective equipment is best done by first establishing a good programme for the selection, use, maintenance, repair and review of such equipment.
- As storage places are fixed, it should be easy to provide adequate instructions for the use and maintenance of personal protective equipment and inform workers (e.g. by posting notices) of areas and processes where such equipment is required.
- Each worker must use the protective equipment that is well fitted to his or her size. Make sure that this particular size is available when change or repair is needed.

POINTS TO REMEMBER

Providing a "home" for each item is an essential part of the enterprise programme for the effective use of personal protective equipment. It represents the commitment of management and the workers concerned.



Figure 105a. The maintenance of personal protective equipment should be well planned, including storage, regular maintenance and training.



Figure 105b. Make sure that access to personal protective equipment and its inventory are easy for workers, and maintain the storage place in good order. Use cupboards with doors where possible as another way to keep personal protective equipment neat and clean.

Work organization



CHECKPOINT 106

Solve day-to-day work problems by involving groups of workers.

WHY

Workers, through their daily experience, know the origins of work problems and often have useful hints about how to solve them, too.

Most work problems can be solved by relatively simple and inexpensive solutions. Group discussion is the best way to find such practical solutions.

Solving work problems often means new changes in working methods and work assignments. Workers involved in the planning of these changes will accept them more easily.

RISKS / SYMPTOMS

- poor communication
- poor understanding
- lack of acceptance
- increased injury or illness rates
- poor worker health

HOW

1. Consult workers about production problems and other work issues of safety concern. Organize group discussion about why these problems have occurred and how they can be solved.
2. Where possible consult the workers about:
 - how fast the work is done (speed, cycle period);
 - in what order the work is done (timing, sequencing);
 - where the work is done;
 - who does the work.
3. Form a small group (or several small groups depending on the size of the problem) and ask the group to come up with feasible options for solving the problem.

4. If technical advice is needed for the solution, provide adequate support for the group discussion in the form of information on practical improvements or experts' advice.
5. Present these options to all managers and workers concerned, and obtain their feedback. Select the most practical and effective solution based on the feedback.
6. Make known to all workers the proposals presented and the result of the implementation of improvements thus chosen. This encourages further promotion of participatory problem solving.
7. Keep a record of the plans made to enable follow-up evaluation.

SOME MORE HINTS

- If there is a bottleneck operation or problem area in your workplace, it probably results from a combination of factors. Therefore it becomes necessary to take several actions at the same time. It is important to ask the worker groups to develop a practical set of solutions that can cover these several important aspects rather than one-sided solutions that leave out other, more important aspects.
- Make sure that workers know that they should report any problems and participate in solving them.
- Obtain the advice of someone who has experience in solving similar problems.

POINTS TO REMEMBER

Explain clearly the bottlenecks or other problems to workers and give them a chance to make suggestions. The best way to do so is to involve workers in group discussion about how to solve the problems.



Figure 106a. Provide opportunities for workers to discuss their ideas about ways of improving each work area.



Figure 106b. Discuss in a small group (or several groups, depending on the size of the problem in question) feasible options for solving the problem.

CHECKPOINT 107

Consult workers on improving working-time arrangements.

WHY

Working-time arrangements can change even within the same length of working hours. There are a variety of arrangements that may differ: starting and finishing times; rest breaks; day-to-day differences in shift lengths; shift systems; flexible hours systems, etc. It is quite often necessary to seek better options.

When changing working-time arrangements, consulting workers is the best way to develop better options.

New working-time arrangements affect all workers. Different workers may have different views. In order to overcome such differences, it is essential to involve everyone concerned from the planning stage.

RISKS / SYMPTOMS

- poor communication
- excessive fatigue
- stress-induced disorder
- poor worker health
- lack of acceptance

HOW

1. Identify possible options for new working-time arrangements through group discussion that involves the workers concerned, or their representatives.
2. In so doing, consider that there are various ways of changing working-time arrangements. Common examples include:
 - change in starting/finishing times;
 - staggered hours;
 - inserting rest breaks;
 - averaging working hours over time;
 - allocating holidays;
 - flexitime;
 - shift-work systems;
 - varying shift lengths;
 - part-time work;
 - job sharing.

3. Compare possible options by knowing how both business requirements and workers' preferences can be accommodated. Then agree on concrete plans.
4. Get feedback from workers before having a test run or introducing new arrangements. Do not be in a hurry. Negotiation before implementation is always indispensable, and further adjustments are, as a rule, needed.

SOME MORE HINTS

- Both business requirements (operating time, staffing levels and production plans) and workers' preferences (changes in working hours, holidays, weekends, family responsibilities) must be duly taken into account. This needs careful planning through group study.
- It is often useful to establish a planning team that includes workers' representatives and supervisors. The team can try to identify practical options. The plans presented by the team can be used as a basis for further workplace consultations.
- Most working-time arrangements cover questions that need to be negotiated by collective bargaining. The possible options proposed by a planning team can certainly be used at this bargaining stage.
- Examples of working-time arrangements used in similar establishments can serve as workable models.
- It is usually preferable to introduce new working-time arrangements on a trial basis. Joint evaluation by management and the workers' representatives should follow.

POINTS TO REMEMBER

Working-time arrangements affect everyday life. Consulting the workers concerned gives better results and makes them more satisfied.

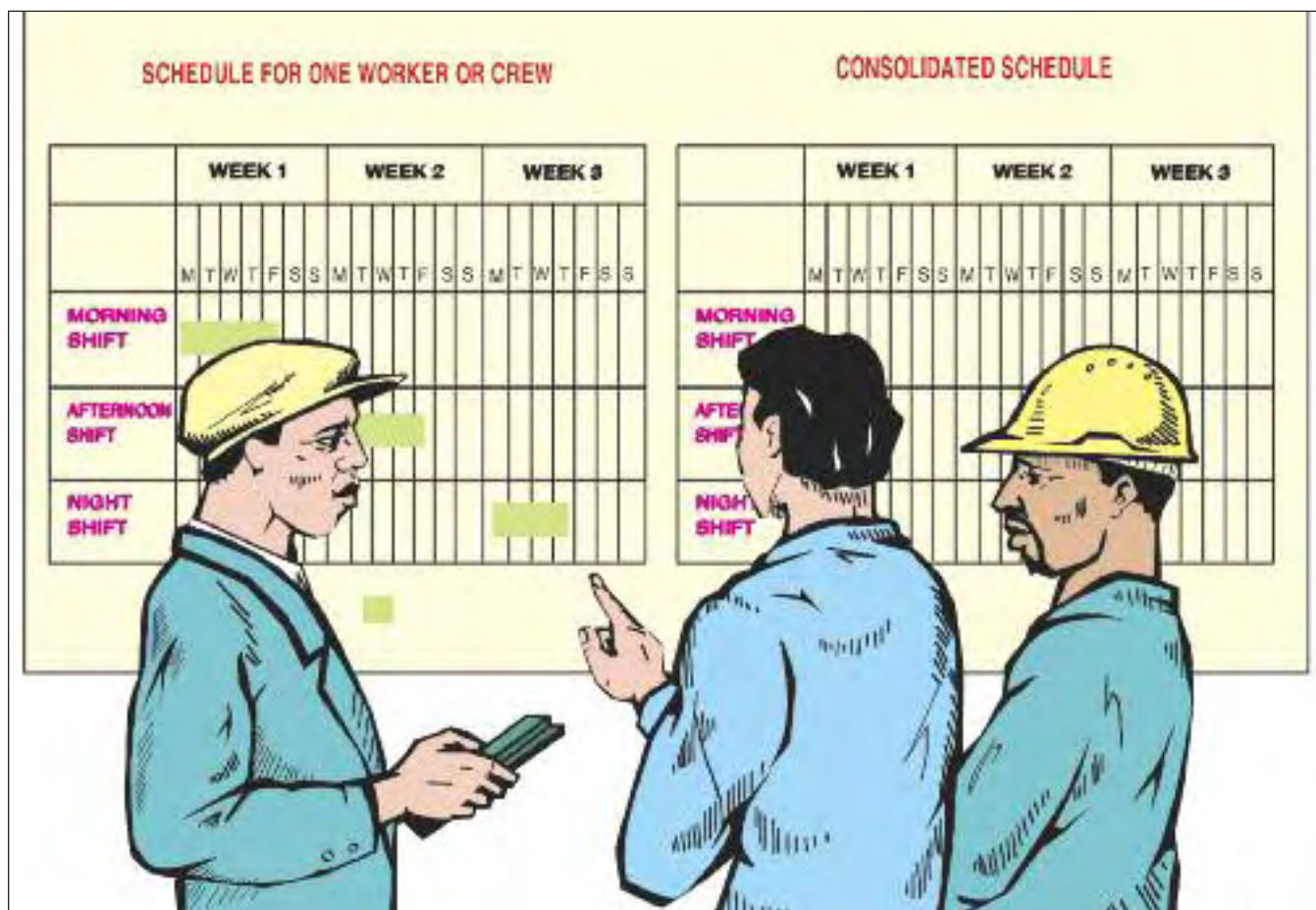

Figure 107. Encourage group discussion and get feedback from workers before introducing new working-time arrangements.

CHECKPOINT 108

Involve workers in the improved design of their own workstations.

WHY

No one knows more about the job than the person who does that work every day. This worker is the best source of information on ways to improve equipment and productivity.

People are more likely to follow up their own ideas in improving their workstation. Involving workers in designing improvements ensures their cooperation in making full use of the modifications achieved.

RISKS / SYMPTOMS

- poor communication
- poor understanding
- lack of acceptance
- increased injury or illness rates
- poor worker health

HOW

1. Ask workers about any problems their workstation causes. Then get their ideas on how to overcome these problems.
2. Use good examples implemented locally as guide materials for formulating feasible improvements.
3. Discuss workers' suggestions immediately. Try to find suggestions that can be implemented right away or after a short period. If there are suggestions that cannot be accepted for technical, financial or other reasons, explain the reasons, restate the problem and ask for other suggestions.
4. Give people recognition for their ideas for improving their workstations. This will encourage future improvements.

SOME MORE HINTS

- Create a concrete opportunity for workers to propose ideas for improving their workstations. One good way is to set a deadline for ideas. Make it clear that these ideas will be discussed in order to find the most feasible solutions. People may not be accustomed to expressing their ideas and may not have enough practice to find realistic solutions; therefore provide enough time for them to think about the problem and propose a solution.
- Always use group discussion for studying the proposals, comparing options and identifying a feasible solution.
- Pick up multiple aspects of the workstation design at the same time. This stimulates various possible ideas and makes it easy to identify feasible improvements.

POINTS TO REMEMBER

Your best source of ideas for improving your workstation is the people who do the work every day.



Figure 108. Discuss workers' suggestions about improving their own workplaces and workstations.

CHECKPOINT 109

Consult workers when there are changes in production and when improvements are needed for safer, easier and more efficient work.

WHY

Workers will perform better in a new situation when they are involved in the process of change to that situation.

Workers' knowledge and experience help to solve production problems or improve workplace conditions.

Many procedures, tasks and jobs are done in a certain way because they have always been done that way. There may be many better ways to achieve the enterprise's goals at little cost. These better ways can be found more effectively by involving workers who know the existing situation.

RISKS / SYMPTOMS

- poor communication
- poor understanding
- lack of acceptance
- increased injury rates
- poor worker health

HOW

1. Ask workers which parts of the existing job are most difficult, dangerous or unpleasant, and how they think these problems could be solved.
2. Create an open environment where workers volunteer ideas for improving product design and work processes. This is usually done by having discussion sessions in small groups. It is necessary to show workers that their ideas are responded to by quick action, or tell them immediately why they cannot be implemented.
3. When there are changes in product design or work processes, consult workers about such changes to find ways to make their work safer, easier and more efficient in the new situation.
4. Develop a procedure for receiving and acting on workers' input (e.g. quality circles or planning committees).

5. Encourage and reward workers who present ideas for improvements.

SOME MORE HINTS

- Involve workers from the initial planning and design stages. This is much better than consulting them only after all essential plans have been made.
- Make plans for safe operations in emergency situations, too.
- Make the reward meaningful to the workers.

POINTS TO REMEMBER

Involving workers in making changes in product design or work processes makes them key to the success of their work.



Figure 109. Create an open environment in which workers feel free to examine risks and problems and exchange opinions about how to deal with them.

CHECKPOINT 110

Inform and reward workers about the results of their work.

WHY

Improving productivity and the workplace requires changes in the way work is carried out. This is effectively done by actively involving workers in planning and implementation of the improvement process.

It is important to show the commitment of the enterprise to constant improvement. Show this commitment by rewarding workers properly when they help to make improvements.

People learn and change by knowing exactly what other people feel and think about their work results.

Tell people if their work needs improvement so that they know what is expected of them. Also tell people when they are doing well. In that way, you can communicate with each other better and improve productivity.

Workers are often isolated from each other and do not have the opportunity to learn what happens after their part of the work has been done. Special care is needed to inform them about the results of their work.

RISKS / SYMPTOMS

- poor communication
- lack of acceptance
- demotivated workers
- low morale of workers

HOW

1. Let people know that you appreciate their work when they do their jobs well. Be specific in telling them exactly what they did well.
2. When people are not doing their jobs well, tell them what they are doing wrong. Focus on what they are doing wrong and how to correct it, while also acknowledging their strengths.
3. Organize opportunities to show people how specific jobs should be done through examples and demonstrations by other experienced workers.

4. Check whether people are told regularly about the results of their work. Keep in mind that this should be done in such a way as to avoid giving the impression that the work is being supervised for strict disciplinary purposes. Tell workers about their work results to let them know how important this is to the workers, other people and the enterprise as a whole.
5. Reward workers by appropriate means that suit the enterprise's overall policy. These can include announcing the best proposals or groups, giving awards, providing some form of remuneration, inviting the best groups to special events or organizing ceremonial occasions.

SOME MORE HINTS

- When people know they are doing their job well, they develop a sense of pride and self-worth. This allows them to be even better workers in the future.
- It is true that people are afraid of criticism. But we can tell people that they are doing their jobs incorrectly, not for the sake of criticism but in order to work together better. This sense of working together should be conveyed by making it a rule within the enterprise to inform people regularly about their work results in a friendly manner.

POINTS TO REMEMBER

People want to do good work. By telling them how they are doing, you can help them achieve this goal.



Figure 110. Make it known that suggestions from workers are most welcome, and organize group talks to discuss them. Reward workers who have helped to propose or implement practical solutions.

CHECKPOINT 111

Train workers to take responsibility and give them the means to make improvements in their jobs.

WHY

Interesting and productive jobs are those in which workers take responsibility for planning and output. Responsible jobs can lead to increased job satisfaction.

Jobs that have no real responsibilities are not only boring but also require continuous supervision, and thus become burdensome both for the enterprise and for the workers.

We all need to feel that our work has some value and that we can develop our abilities and skills. Towards this end, it is important to train workers to take on responsible jobs.

RISKS / SYMPTOMS

- poor understanding
- lack of acceptance
- poor communication
- low morale of workers

HOW

1. Organize group discussions on how to improve jobs. Include in the discussions ways in which jobs with more responsibilities can benefit both the enterprise and the workers.
2. Incorporate discussions on work organization and job content within training sessions on job improvement and career development.
3. Use examples in such training of well-organized jobs that can increase job satisfaction.
4. Promote arrangements for group work as this can increase the awareness that more responsible jobs for the group are more interesting and good for skills development.
5. Provide good training opportunities, either on the job or through special training sessions or courses, for taking on more responsible jobs with multiple skills.

SOME MORE HINTS

- Increase mobility within the enterprise so that the same worker can be assigned to different kinds of job and can thus learn to take responsibility in different situations.
- Make sure that taking more responsibility at work can lead to better work results and can be rewarded better in the long run.
- Discuss with workers the jobs in your enterprise that combine appropriate responsibilities and are productive.

POINTS TO REMEMBER

By taking on more responsibility, the worker can see the connection between his or her own work role and the overall activity of the enterprise. This makes the work more productive and more satisfactory in the long run.

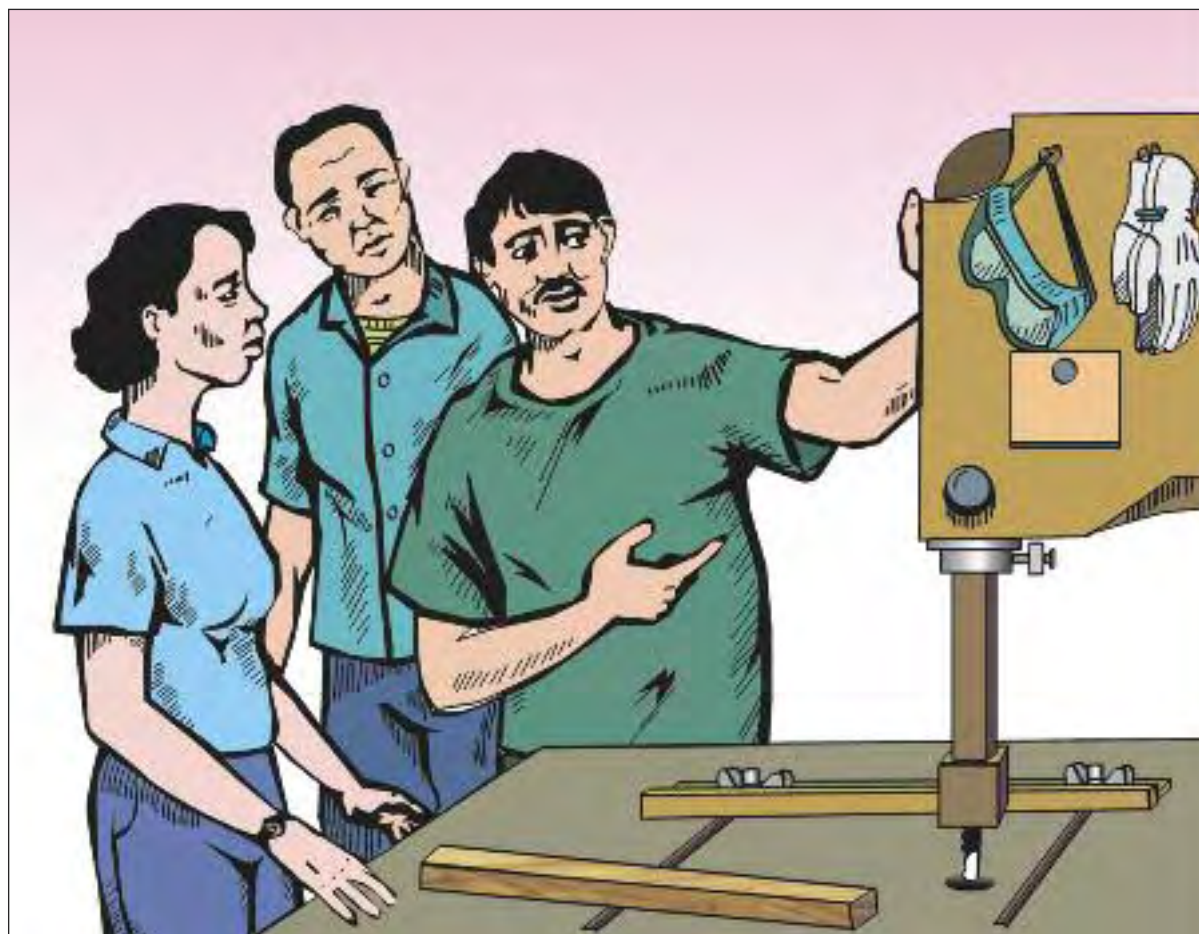

Figure 111a. Train workers to take on more responsible and safer jobs.

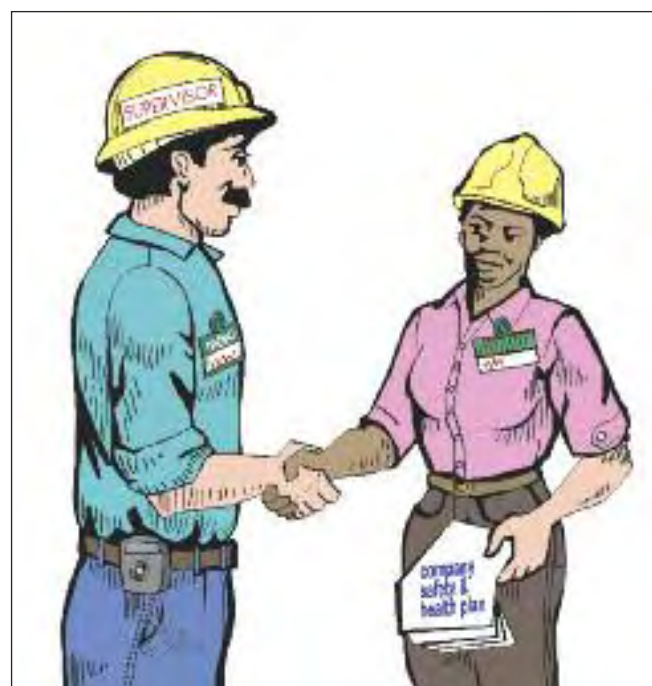

Figure 111b. Make the company plan for better workplaces known to each individual worker, and encourage mutual communication.

CHECKPOINT 112

Train workers for safe and efficient operation.

WHY

Training and retraining of workers in safe and efficient operation are an indispensable part of daily production.

Machines have advantages over people in strength, speed and accuracy. To realize these advantages fully, workers must be trained to use machines safely and efficiently.

Improper use of machines can cause work slowdowns, work stoppages, damage and injury. These events entail costs which must be added to the already high cost of the machinery that was not used properly.

RISKS / SYMPTOMS

- serious injury or accident
- poor worker health
- poor understanding
- lack of acceptance

HOW

1. Establish training programmes involving all workers. For newly recruited workers, organize training sessions that include training in safety and efficient production.
2. In training workers, use information provided by the manufacturer of the machines and equipment. Translate this information into local languages. If it is too complex, use step-by-step procedures.
3. Involve workers who are already proficient in using the machines in the training, in particular by letting them demonstrate proper and safe operation. When workers master skills, let them coach new workers.
4. Use good examples (pictures, videos, demonstrations) as models for others to learn from.

SOME MORE HINTS

- You can obtain detailed information about the machinery from the manufacturer or the company that sold you the equipment. To find out about these companies, seek help from trade associations, your

dealers, fellow companies or available registry books.

- Train workers on new machines when they are brought into the enterprise, not after problems appear.
- You may want to trace errors, accidents or defects to particular machine operations. These may be eliminated with proper training using the local language and relevant examples.
- If you make up your own training materials, remember to:
 - use simple ideas;
 - use pictures or drawings to illustrate points;
 - make sure that the words and language are clear to workers.

POINTS TO REMEMBER

Training workers about how to use machines is a one-off cost. Errors, rejections and scrap losses, injuries and low quality are paid for forever.



Figure 112a. Train workers to use machines properly and safely.

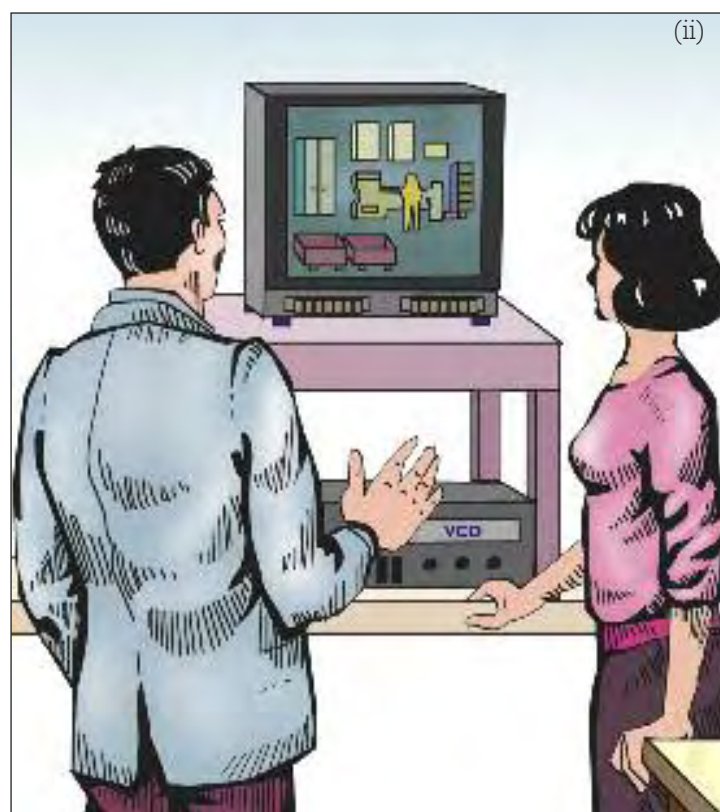

Figure 112b. (i) and (ii) When training workers, include good visual examples and learning by doing.

CHECKPOINT 113

Provide up-to-date training for workers using computer systems.

WHY

Computer work is developing very fast. Up-to-date training ensures optimum utilization of computer facilities and resources.

Properly planned and up-to-date training improves computer workers' comfort and satisfaction.

Training to bring workers up to date on available facilities and programmes minimizes costly errors and system breakdowns, and improves product quality.

RISKS / SYMPTOMS

- repetitive strain
- muscular strain
- upper limb disorder
- stress-induced disorder
- poor understanding
- poor communication

HOW

1. Depending on individual skills, all computer workers should undergo basic introductory training on:
 - the purposes and major functions of the system, and how system components work and are interconnected;
 - how to use different equipment and how to adjust a workstation (including display screen, keyboard and chair height, viewing angle and distance, contrast, lighting and glare prevention, and how to organize various items so that they are within easy reach).
2. Depending on individual needs, advanced training should be provided for computer workers to acquire skills and knowledge relevant to their existing and future tasks on:
 - how to use and interact most effectively with available systems for performing the different tasks required;

- what action to take in the case of system failures (including procedures to rectify such failures, disengaging from the system, whom to consult, etc.).

3. Make a survey of training needs and establish a training schedule. This schedule should be updated at regular intervals, say, every six months.

SOME MORE HINTS

- When introducing new programmes, procedures or equipment, organize training sessions for computer workers. These sessions must allow enough time for individual exercises.
- Tailor the training programme according to individual needs and capabilities. Allow more time for those who need it.
- Organize a separate training course for new employees and make sure that they receive up-to-date training.

POINTS TO REMEMBER

Up-to-date training is the most effective way to utilize rapidly developing technologies. Such training ensures high work quality for every worker.



Figure 113. Up-to-date training through learning by doing improves the efficiency, comfort and satisfaction of computer operators.

CHECKPOINT 114

Provide opportunities for easy communication and mutual support at the workplace.

WHY

Jobs are carried out far better when people know what others are doing or thinking, and how they can cooperate with each other.

Poor communication often leads to delays in work or low quality of products, and even to mistakes and accidents.

People are busy completing their assigned tasks, and tend to be isolated from others. Therefore concrete opportunities must be created and built into daily work in order to facilitate communication among workers, and in order for them to support each other's work.

RISKS / SYMPTOMS

- poor communication
- stress-induced disorder
- lack of acceptance

HOW

1. Arrange work procedures so that members of the section or work team have the chance to communicate from time to time. Also encourage casual talk. Avoid totally isolated work as much as possible.
2. Organize brief meetings, if appropriate before every shift, to deliver instructions, exchange the day's workplans, and have question-and-answer sessions.
3. Encourage group planning and group implementation of tasks, especially by assigning work to the group instead of to individuals. This facilitates communication and constant cooperation.
4. Provide adequate opportunities for training and retraining workers within daily work. This helps to improve communication and mutual support.

SOME MORE HINTS

- Use newsletters, leaflets, updated instructions, posters and occasional verbal presentations to increase communication.
- Provide changing rooms, rest areas, drinking facilities and eating areas for joint use so as to give workers more chance to talk to each other.
- Provide possibilities for acquiring multiple skills, and encourage occasional job rotation. This helps increase communication and mutual support.

POINTS TO REMEMBER

Create, intentionally, more chances of communicating with each other. This increases the sense of working together and can lead to improved work results.



Figure 114a. Encourage communication at work and group implementation of tasks.



Figure 114b. Assign work responsibilities to a group of workers instead of individuals. This helps to increase mutual communication and thus facilitates better work flows and improved work results.



Figure 114c. Organize a briefing meeting before every shift, and provide opportunities for training and retraining workers within daily work.

CHECKPOINT 115

Consider workers' skills and preferences in assigning people to jobs and providing them with opportunities to learn new skills.

WHY

Work methods are rapidly changing with the introduction of new technologies. By training workers in new skills, it is easier to organize work systems that are more productive and safer.

By acquiring new skills, workers can do multiple jobs. This greatly helps the organization of job rotation and the replacement of absent workers without looking for additional workers.

Multi-skilled workers can more easily set up group work to improve efficiency and to cut supervisory costs. Some workers may be overstrained, while others are under-utilized. Finding proper jobs for different workers needs constant planning and review.

Poorly assigned jobs can mean many lost opportunities and extra costs. Careful assignments offer many benefits.

Workers' preferences are as important as their capacities and skills. Take them into account to motivate workers and to help them feel individually responsible for their work.

RISKS / SYMPTOMS

- poor communication
- stress-induced disorder
- poor understanding
- lack of acceptance

HOW

1. Know each worker's skills and preferences, and consult the worker and those experienced in job design about the job to be assigned. Identify their interests to learn new skills or try alternative jobs.
2. In assigning jobs, first consider whether the jobs are well designed according to the following principles:
 - jobs should make clear who is responsible for output and quality;
 - jobs should help workers to develop skills and become interchangeable;
 - jobs should occupy each worker fully but should remain within each worker's capacity.
3. Combine tasks so that each worker is responsible for a good set of tasks that becomes interesting and requires trained skills.
4. Assign workers to the jobs that are best suited to their skills and preferences.
5. Provide training and retraining as required to improve job assignments.

SOME MORE HINTS

- Consider that if you do not combine tasks, it is very difficult to keep workers fully occupied. Fragmented tasks do not attract workers and make it difficult to meet their preferences.
- Proper job assignments cannot be achieved by simply selecting workers for each existing job. Efforts are always necessary to improve the way existing jobs are done.
- Good job assignments can reduce the cost of supervision and make workers responsible for the output and quality of their work. Organize special short training sessions on new skills to confirm the training needs and to encourage people to participate in further training.
- Evaluate progress in learning new skills regularly (e.g. once a year) and improve the arrangements further.
- Make full use of training courses offered by training providers during working hours and other training offered by institutions.

POINTS TO REMEMBER

Assign to each worker a responsible job that best suits his or her skills and preferences. This is achieved by combining knowledge of the worker and improvement of the job design.



Figure 115. In assigning people to jobs, take into account not only workers' skills but also their preferences.

CHECKPOINT 116

Set up work groups, each of which collectively carries out work and is responsible for its results.

WHY

Today, many enterprises find it beneficial to assign work to groups instead of to individuals. This is because work groups are more productive, with much less unnecessary work and fewer mistakes.

Using group work arrangements, it is easier and less time-consuming to set tasks for a group than for individuals. As a result, less supervision is needed and the work flows more smoothly.

In group work, workers have better opportunities for communication and acquiring multiple skills.

In group work, workers can flexibly help each other to overcome bottlenecks and become collectively responsible for productivity, quality and discipline. This helps to create a good work climate.

RISKS / SYMPTOMS

- poor communication
- poor understanding
- lack of acceptance

HOW

1. Assign the responsibility to plan and implement a sequence of tasks to a group.
2. Consider grouping assembly or similar workers around one table and increase arrangements by which the workers help each other and share the tasks.
3. Replace a rigid conveyer line with "group workstations" with buffer stocks (supplies of unfinished workpieces) between them.
4. Introduce mechanized or automated processes in such a way that a group of workers using the processes work together in planning and day-to-day operation.
5. Train workers to acquire multiple skills so that they can exchange tasks and share work within the work groups.

6. Make sure that rewards depend on the performance of the group as a whole as well as on the performance of individual group members.

SOME MORE HINTS

- Make sure that each work group can obtain the information and expertise it needs, for example concerning supplies and maintenance.
- The group should have control over the methods used to do the work and over the way the work is shared among group members.
- The group should be given regular information about its performance that can be shared by all the group members.
- Make sure that there is no "outsider" in any of the groups. Disruption by outsiders who feel no responsibility for the group's work can cause a lot of problems.

POINTS TO REMEMBER

Autonomous work groups that are collectively responsible for work planning, the way work is shared and product quality are very productive because groups can work faster and better than the same number of separate individuals.



Figure 116. Assign to a group the responsibility to plan and implement a sequence of tasks.

CHECKPOINT 117

Improve jobs that are difficult and disliked in order to increase productivity in the long run.

WHY

In every enterprise there are bottleneck operations that are particularly difficult and therefore disliked by workers. Special effort is needed to improve these bottlenecks.

Until recently, it was assumed that job characteristics were predetermined by technical and economic requirements. However, it is today possible to design better jobs by using more up-to-date technologies and improved work organization. There is good scope for defeating difficult and monotonous jobs.

By improving difficult jobs, it becomes easier to assign jobs, rotate workers and make effective production plans.

RISKS / SYMPTOMS

- poor communication
- excessive fatigue
- lack of acceptance
- increased injury or illness rates
- poor worker health

HOW

1. Examine the jobs within the enterprise that are considered to be difficult. Typical examples of such jobs are:
 - physically demanding tasks, such as manual handling of heavy materials;
 - work exposed to excessive heat, cold, dust, noise or other hazardous agents;
 - jobs that are often performed in irregular working hours such as frequent night shifts;
 - repetitive work that is fragmented, boring and isolated;
 - jobs requiring little skill with only limited career possibilities;
 - skilled but arduous jobs that are stressful and fatigue workers.

2. Mechanize difficult tasks but avoid jobs resulting in machine-paced or monotonous tasks.
3. Improve equipment and sequence of work to make the job easier and more responsible.
4. Combine tasks (e.g. to constitute a job performing a sequence of assembly tasks) so as to have a longer cycle time.
5. Make the job less machine-paced or conveyor-paced (e.g. by having both upstream and downstream buffer stocks – unfinished workpieces – of unfinished products which allow the worker to pause or change the pace of work).
6. Add more responsible tasks such as inspection, maintenance and repair.
7. Promote multi-skilled jobs and sharing of jobs to avoid concentrating difficult jobs on a small number of workers.

SOME MORE HINTS

- A very flexible way of improving job content is group work. This makes it possible to overlap skills and share difficult work.
- Elimination of difficult jobs must also be planned by involving workers. Group discussion of the change process is indispensable.
- Emphasize that the reduction of difficult jobs not only reduces occupational stress and ill-effects, but also facilitates better use of skills and improves career prospects. The benefits will include a more productive enterprise.

POINTS TO REMEMBER

As there are no simple solutions to the problems of difficult jobs, take advantage of suggestions from both managers and workers. Improvement is usually needed in equipment and work methods, as well as in work organization.



Before



After

Figure 117a. (i) and (ii) Improvement is needed not only in work equipment but also in the way work is organized. Group work to do a sequence of jobs can be a good starting point for improving work organization.



Figure 117b. There are different ways of doing the same job. By improving difficult or uninteresting jobs, it becomes easier to assign jobs, rotate workers and make more effective work plans.

CHECKPOINT 118

Combine tasks to make the work more interesting and varied.

WHY

Repetition of the same monotonous tasks and lack of variety cause boredom and fatigue. The result is low efficiency and a negative work attitude. Frequent changes in tasks are needed.

Monotony can cause attention to wander. This can easily lead to low-quality work and even to accidents. Monotony must be defeated to keep workers alert and productive.

Performing a number of tasks prepares workers for multiple skills. Multi-skilled workers are more productive and help the enterprise to organize a better flow of work.

RISKS / SYMPTOMS

- repetitive strain
- monotony
- muscular strain
- stress-induced disorder

HOW

1. Combine two or more tasks to be done by one worker. Provide the necessary changes in the workstation and tools.
2. Combine a series of tasks so that the cycle time per worker becomes longer.

3. Allow rotation of jobs within a certain number of workers so that each worker can have frequent changes of task.
4. Arrange for autonomous work groups, in each of which several workers have joint responsibility for performing the combined tasks and share the work.
5. Modify workstations so that combined tasks can be efficiently performed by each worker.
6. Train workers to adequately performing new combined tasks.

SOME MORE HINTS

- Provide workstations that the same worker can use for performing multiple tasks and which can thus be used by different workers.
- While combining tasks, provide opportunities to walk around or change position from sitting to standing or from standing to sitting.

POINTS TO REMEMBER

Combine tasks to defeat monotony and make the work more productive.



Figure 118a. Provide multitask workstations for use by different workers. This helps the enterprise organize a better flow of work.



Figure 118b. (i), (ii) and (iii) Combine two or more tasks to be done by one worker so that the cycle time is longer and the work more interesting.



Figure 118c. (i) and (ii) Combine work at a visual display unit with other tasks to avoid continuous visual display work.

CHECKPOINT 119

Set up a small stock of unfinished products (buffer stock) between different workstations.

WHY

Small supplies of buffer stock in front of and behind each workstation eliminate time spent waiting for the next workpiece. They also help to eliminate time pressure as the next worker or machine will not have to wait either.

Working at the worker's own pace without time pressure gives much flexibility at work. It also gives the sense of being independent, treated fairly and better organized. This can lead to improved productivity in the long run.

Such buffer stock is part of a modern concept that machine-paced tasks, such as conveyer belt work, should be replaced by more flexible work organization.

RISKS / SYMPTOMS

- repetitive strain
- monotony
- stress-induced disorder

HOW

1. Rearrange the work flow so that there can be a small supply of buffer stock between subsequent workstations (e.g. between workstations A and B, between workstations B and C, between workstations C and D, etc., when the work flow is from A to B, B to C, C to D, etc.).
2. Set up places for this buffer stock, considering the size, type and possible number of workpieces that may be placed there.
3. In the case of small workpieces, simple bins or small pallets with dividers are usually sufficient.
4. For bigger and heavier workpieces, such as assembled metal products or large wooden items, special racks or pallets, or mobile storage shelves should be used.
5. Minimize the floor space taken up by the buffer stock, and ensure easy access by the next worker.

SOME MORE HINTS

- Choose the appropriate height for the buffer and design it so as to minimize the effort needed to put stock in or take it out.
- Stock workpieces in a systematic manner so that they can be seen at a glance and so that handling them is easy.
- When buffer stocks are present, workers can build up a small advance which they can use to take a few seconds' rest, correct machine settings or fetch some spare parts without slowing down the operation as a whole. This ensures continuity and flexibility.
- If it is necessary to transport buffer stock from one workstation to the next process, it is useful to provide a mobile rack to store the buffer after finishing the work at this workstation.

POINTS TO REMEMBER

Buffer stock (small supplies of workpieces between workstations) is used in many modern production systems. This is a sign of good work organization.



Figure 119a. Assembly line with intermediate buffer stocks.

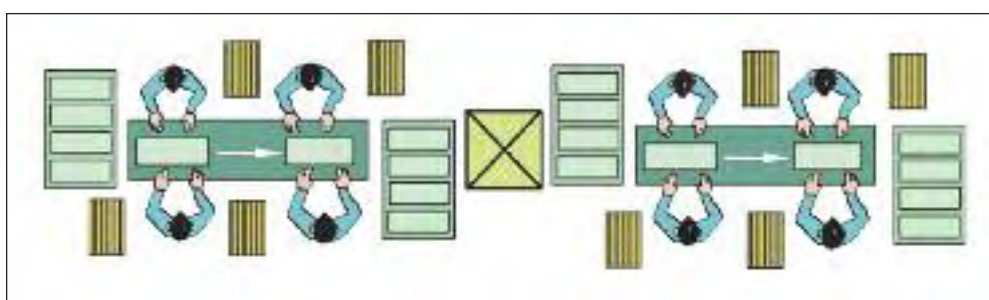

Figure 119b. New arrangements based on group workstations and buffer stocks. (i) Buffer stock. (ii) Automated assembly unit. Note that buffer stocks and group workstations allow for partial automation without disruption of the production process.

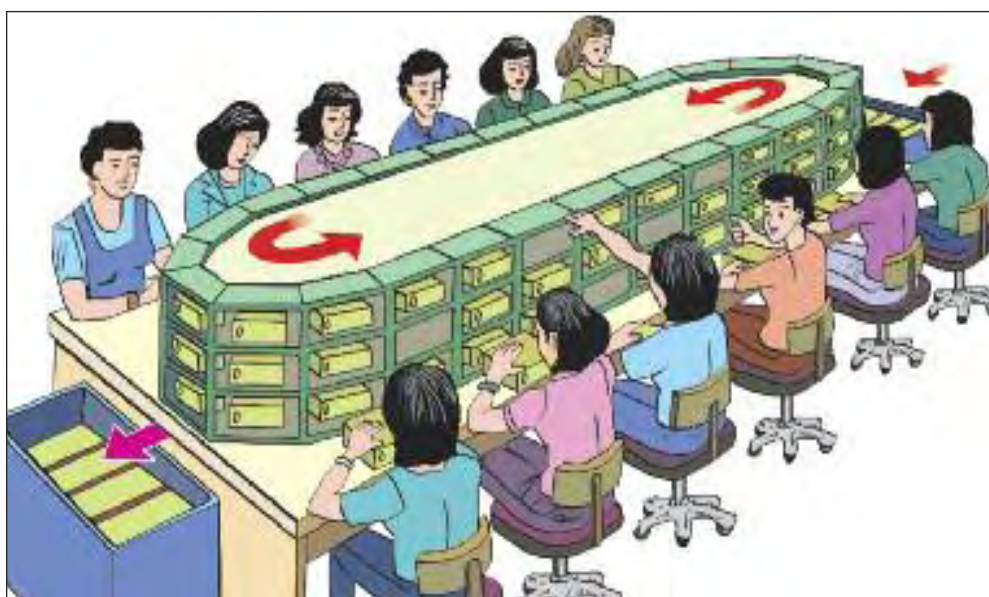

Figure 119c. Table-top rotatable buffer line.

CHECKPOINT 120

Assign responsibility for day-to-day cleaning and housekeeping.

WHY

Good housekeeping cannot be left to spontaneous, unplanned activities. It needs planning and cooperation.

Good housekeeping for order and cleanliness will begin only when management takes responsibility for it. This must be shown by making housekeeping plans and by clearly assigning responsibility to supervisors and workers.

Day-to-day cleaning cannot be left until the last few minutes of the working day. Planning is essential, including orderly layout, good materials storage and handling facilities, a waste disposal policy and cleaning responsibilities.

RISKS / SYMPTOMS

- poor worker health
- increased injury or illness rates
- slips, trips or stumbles

HOW

1. Make it clear to all workers that good housekeeping is the enterprise's established policy and that therefore every effort is made to keep the premises orderly and clean, and to provide sufficient storage, transport and waste disposal facilities. (Checkpoints 1–17 in this manual related to materials storage and handling will help.)
2. Assign the responsibility to clean each work area to a particular group of workers with a leader or designated responsible person. This responsibility should include not only cleaning the area but also maintaining good housekeeping in the whole area.
3. Ask each such group to inspect the work area regularly and to evaluate the housekeeping performance.
4. Discuss with the group representatives what measures would be helpful to support their cleaning and housekeeping efforts.

SOME MORE HINTS

- Typical examples of measures needed to facilitate cleaning and housekeeping include: marking of passageways and exits; setting aside special areas for storage; providing as many racks or stands as possible for materials and semi-products; using pushcarts and hand-trucks combined with the use of pallets; and providing waste receptacles.
- Use floor-covering materials suitable for the work and for cleaning.
- Provide designated places for storing cleaning equipment inside or near the work area to be cleaned.
- For dealing with hazardous chemicals during cleaning and housekeeping, special training about safety is always needed, taking into account the specific hazards involved.

POINTS TO REMEMBER

Good housekeeping needs good planning. The experience of planning and maintaining good housekeeping will be useful for organizing other workplace improvements. So start good housekeeping by clearly assigning responsibility for cleaning and housekeeping.



Figure 120. Assign responsibility for good housekeeping, cleaning and maintenance.

CHECKPOINT 121

Provide short, frequent pauses during continuous precision or computer work to increase productivity and reduce fatigue.

WHY

Prolonged work doing precision tasks or at a computer requires a fixed posture and strains the eyes. The resulting pain and discomfort can be prevented by combining the precision or computer work with other tasks, in addition to providing an adjustable table and chair.

Variety in work tasks can increase job satisfaction, leading to improved well-being and higher productivity.

Prolonged computer work is usually connected with mere repetition of simple tasks (e.g. data entry work). Mixing these simple tasks with more skilled and non-computer work can achieve variations in physical, visual and mental demands, and thus reduce common problems reported from computer work.

RISKS / SYMPTOMS

- upper limb disorder
- eye strain
- monotony
- stress-induced disorder
- excessive fatigue

HOW

1. Combine repetitive elements of work with non-repetitive, dialogue-style tasks. For example, combine data entry tasks with data dialogue and data enquiry tasks.
2. Organize work for a group of operators together so that each operator can perform multiple tasks.
3. Rotate jobs so that each worker can perform both precision or computer tasks and non-precision or non-computer tasks (such as conventional office work or other activities).
4. Retrain workers in both computer and non-computer tasks. This will improve flexibility in work organization and result in better utilization of equipment and human resources, as well as improving the morale of workers.
5. Allow for short breaks after, say, every hour of work. It is not advisable to work for several hours without taking a break. Changing body positions and focusing the eyes on something other than the screen will reduce fatigue.
6. Allow for the insertion of short tasks that are different from precision or computer work. For example, changing seated positions, switching to standing work, or taking a short walk to fetch something or for communication, greatly help to reduce muscle and eye fatigue.
7. Spend the break period away from the precision work or computer workstation.

SOME MORE HINTS

- Encourage workers to participate in finding non-computer tasks that they would like to combine with their regular precision or computer work.
- Promote training for computer workers in more skilled computer work (which normally involves varied tasks and dialogue work) and in non-computer work available at the enterprise. Resting your eyes occasionally away from the screen will prevent eye fatigue. This is difficult to do unless you leave the computer workstation, so taking breaks is a help.
- Combine your pauses with relaxing exercises, such as walking, stretching or simple gymnastics.
- Taking pauses because you are fatigued is less effective than taking pauses before the onset of fatigue, so make it a rule to have a pause at regular intervals, say every hour.

POINTS TO REMEMBER

Workers who combine precision or computer tasks and non-precision or non-computer tasks during the working day are generally more satisfied and report fewer complaints.



Figure 121a. Take short and frequent pauses during continuous computer work.



Figure 121b. Combine your pauses with relaxing movements.

CHECKPOINT 122

Provide opportunities for physical exercise for workers.

WHY

Physical exercise is necessary to maintain the health and morale of workers. Exercise helps the development and maintenance of muscle strength and flexibility of the body. Physical exercise also maintains general body health by generating good blood flow, so ensuring healthy organs.

The use of muscles at work depends on working motions and postures. Sometimes only limited groups of muscles are used excessively or in a constrained manner. Physical exercise can induce a dynamic use of muscles and help these particular groups recover from fatigue. It can thus help prevent the development of undue strains that may lead to musculoskeletal disorders such as low back pain or upper limb disorders.

The level of fitness required for the work is dependent on the demands of the work. Physical fitness may tend to develop disproportionately or even decline in some forms of work. Physical exercise helps build physical fitness in a more systematic way.

RISKS / SYMPTOMS

- muscular strain
- repetitive strain
- upper limb disorder
- low back pain
- excessive fatigue
- poor worker health

HOW

1. Encourage workers to undertake physical exercise before or during work to maintain their fitness.
2. Invite workers to do physical exercise during a short break taken after sedentary work in a constrained posture such as computer work.
3. Select exercises that help balance the physical demands of the work to ensure that they do not exceed the capabilities of the worker.
4. Ask workers about the effects of physical exercise done before, during and after work, and reflect their views on the appropriate design of work. The design of the work should combine a mixture of physically active tasks and less active tasks to enable the body to recover from the demanding tasks.
5. Consult physical fitness experts about an appropriate design of physical exercise done before or during work.

SOME MORE HINTS

- The frequency of physical exercise should depend on the demands of the work and the activities done outside work hours.
- Provide facilities for building physical fitness that can be used by workers during breaks or after work.
- For jobs in sedentary forms of work or with little physical exercise, encourage workers to conduct a programme of exercise or sports activities at least a few times per week.

POINTS TO REMEMBER

Work in a constrained posture or physically excessive work can be damaging to the body. Encourage workers to do physical exercise before, during or after work.

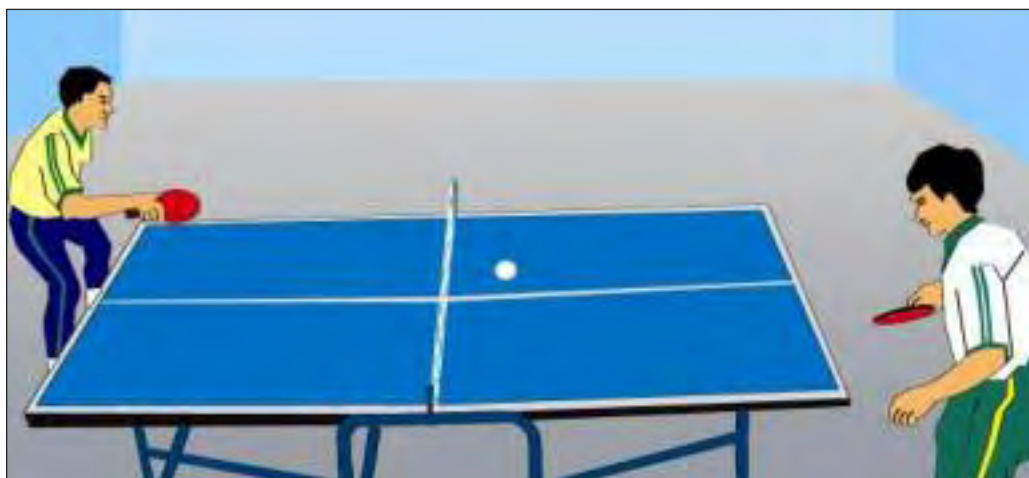

Figure 122a. Encourage workers to undertake physical exercise and sports activities to maintain their fitness.



Figure 122b. Invite workers to do physical exercise during a short break taken after sedentary work in a constrained posture such as computer work.

CHECKPOINT 123

Encourage full participation by women and men workers in finding and implementing work improvements.

WHY

Women workers generally differ from men in height, strength and bodily dimensions such as hand grip size. Adequate tool and workstation design parameters may be missed if women do not participate in work design or work improvements.

In some cultures, it may be that women are more reserved about voicing their opinions about their work or necessary changes. Particular attention should be paid to effective participation of women.

Women often have a double burden in caring for the home and family before and after work. This may prevent them from full participation in finding fair job opportunities or developing work improvements. Their active participation greatly helps find and implement adequate work improvements.

RISKS / SYMPTOMS

- excessive fatigue
- increased injury or illness rates
- stress-induced disorder
- upper limb disorder
- poor communication
- lack of acceptance

HOW

1. Encourage active participation of women workers in work design and redesign. Provide opportunities for them to take an active part, be consulted or join in decisions in making workplace changes.
2. Encourage women workers in the same work area to work together to identify problems and solutions to be brought forward.
3. Provide formal and informal occasions to reflect views of women and men workers on an equal basis in making work improvements. Questionnaire surveys, interviews or suggestion schemes may help.

4. Identify informal leaders among women workers and include them in workplace improvement training so they can gradually bring more women workers into the improvement process.
5. Provide education for women and men workers on the importance of providing equal opportunities for all genders in the workplace.
6. Institute clear management policies and training for all workers to prevent undue gender-based treatment or sexual harassment.

SOME MORE HINTS

- If either men or women workers are not involved in the improvement process, they may resist changes suggested by others.
- Allowing women and men workers to choose their tool and glove size, as well as having the ability and knowledge to adjust their workstations or methods to accommodate their size, strength and skill will create a more productive workplace.
- Improvement discussions should take place during regular work hours because women who have the double burden of home and work may not be able to participate outside these hours.

POINTS TO REMEMBER

Actively involve women and men workers in finding and implementing work improvements. This helps build equitable working conditions and adjust work tasks and equipment to their needs.



Figure 123a. Encourage active participation of women workers in joint design and redesign of work assignments and workplace conditions.

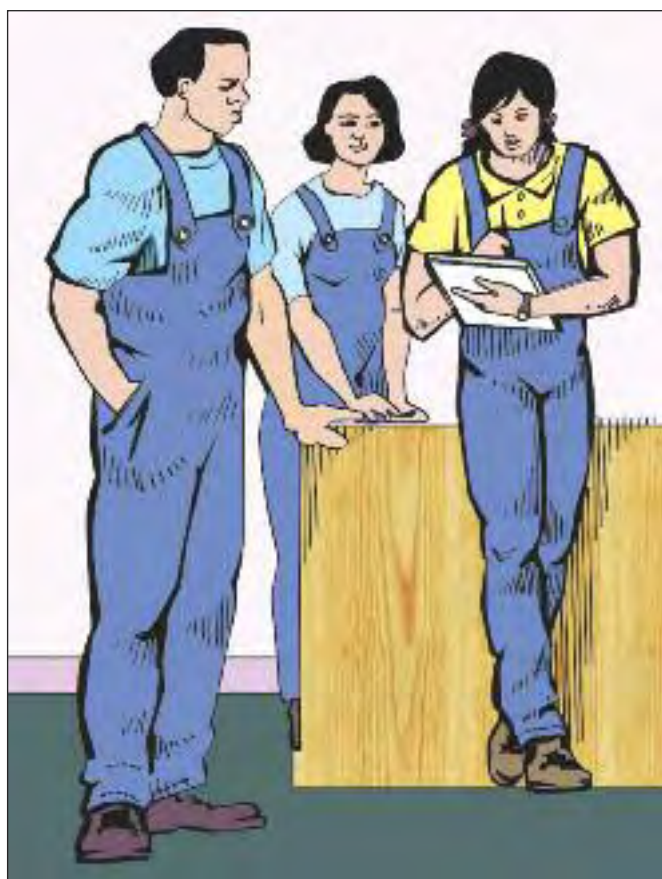

Figure 123b. Provide formal and informal occasions to reflect views of women and men workers in making workplace improvements.

CHECKPOINT 124

Assist migrant workers to perform their jobs safely and efficiently.

WHY

In this era of globalizing economy, more and more migrant workers with different social and cultural backgrounds are entering jobs departing from their homelands. Enterprises increasingly depend on them to have an adequate workforce. These workers need support to make their work safe and efficient.

Migrant workers have specific workplace needs that have direct impacts on their safety and work efficiency. Their common needs include overcoming language barriers and information gaps, meeting basic cultural requirements related to food and religion, and training in work skills. It is necessary to create a productive teamwork environment that can be shared by migrant and domestic workers working in the same workplace.

There are many practical ways to meet the basic needs of migrant workers. Special care should be taken to involve them in planning and improving the workplace conditions.

RISKS / SYMPTOMS

- increased injury rates
- stress-induced disorder
- poor communication
- poor understanding
- lack of acceptance

HOW

1. When migrant workers join your workplace, listen to them carefully and learn about their specific needs at work. These needs might include safety instructions written in their own language, working time arrangements, welfare facilities, food preferences, religious requirements and training in work skills.
2. Make a workplace plan to meet the essential needs of migrant workers. Implement safety-related actions as a high priority in preventing accidents.

3. Carefully explain to migrant workers all the safety symbols, signs and instructions used at their workplace. Ensure they all clearly understand the symbols and signs. Add to the symbols and signs instructions written in their languages.
4. Develop and distribute safety information materials in an easy-to-understand manner written in the languages of migrant workers.
5. Design and conduct special training programmes on work safety, health and ergonomics for migrant workers. The programme should include safety rules, clear understanding of safety signs and instructions as well as precautions to protect themselves from long-term health risks. The training may be organized in their own languages.

SOME MORE HINTS

- Create an open and amicable workplace atmosphere and encourage questions and consultations on safety, health and ergonomics from migrant workers.
- Help migrant workers establish good communication channels with domestic workers. Hold meetings, joint training sessions, informal gatherings, etc. to help migrant and domestic workers understand each other well. Help domestic workers understand the cultural needs of migrant workers as a requirement to build a safe and productive team.
- Build a long-term mechanism to reflect the needs of migrant workers. For example, safety and health committee activities can include safety and health issues of migrant workers and practical solutions.
- Exchange experiences with other workplaces where migrant and domestic workers could form productive work teams.

POINTS TO REMEMBER

Migrant workers become productive when provided with practical support such as training, teamwork arrangements and cultural adaptation.



Figure 124a. Involve migrant workers in making a workplace plan to meet their essential needs. Implement safety-related actions as a high priority.

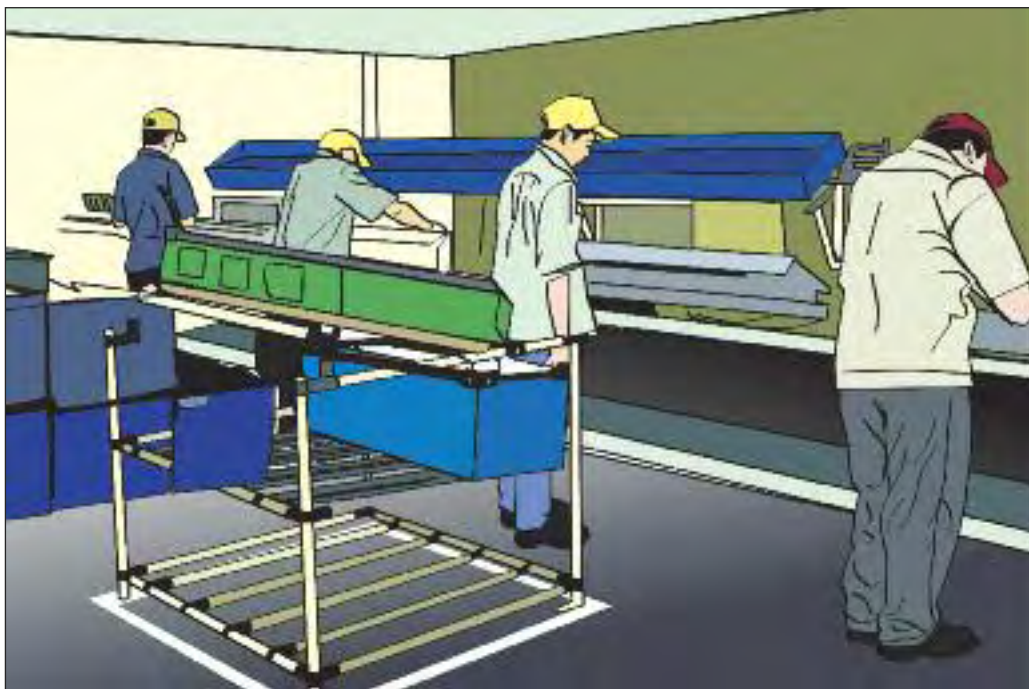

Figure 124b. Improve workplace conditions in various ways so that both unskilled and skilled workers including migrant workers can jointly work effectively and safely. Instructions and signs concerning work processes and safety precautions must be given to all these workers in an easy-to-understand manner.

CHECKPOINT 125

Assign appropriate workloads, facilitate teamwork and provide adequate training for young workers.

WHY

Younger workers have different physical and mental capacities compared with mature workers. They often do not have enough experience with their work and feel the need for adequate support.

It usually takes time for young workers to get accustomed to work habits and to fulfilling their tasks as required. It is important to provide guidance and support to obtain sufficient work experience and solve problems faced during work.

In dealing with workplace risks, the most vulnerable workers are those with the least experience on the job. This "new-to-work" factor is often confused with the "age" factor of young workers. Training must be provided about dealing with the risks in their early periods of work.

The best way to help young workers increase their performance is to assign experienced older people to guide and train them. Through good communication between the young and older workers, a better workplace atmosphere may be created.

RISKS / SYMPTOMS

- increased injury rates
- stress-induced disorder
- poor communication
- poor understanding
- poor worker health

HOW

1. When young workers are newly allocated to a workplace, provide adequate job training including explanation of the work system and support measures for the young workers. Regular consultations with them are helpful.
2. Assign appropriate workload to young workers by reviewing teamwork arrangements so that they gradually gain sufficient work experience.

3. Provide training in dealing with risks at work for young workers that takes account of their background knowledge, skills and physical fitness. Adequate safety training can reduce the risks of work-related health problems for young workers.
4. Assign older workers to support young workers. These supporters should try to keep daily contact with the young workers and guide them before problems happen. As young workers often hesitate to consult senior workers about their problems, this daily contact is essential.
5. Check all aspects of work to make sure that the workload does not exceed the capacity of young workers.
6. Provide flexible time to allow young workers to continue their education.

SOME MORE HINTS

- Make sure that young workers are old enough to work according to law.
- Try to create an atmosphere that enables young workers to consult easily with older workers and foremen at the workplace. If appropriate, organize group discussion so that young workers can find solutions to their problems.
- It is important to educate young workers about how to perform their work with fewer health risks. Education is necessary not only in work skills but also in personal relationships.
- Ensure that support for young workers is provided based on requests from them. Young workers should consult with older workers before taking jobs that could pose dangers to their safety and health.

POINTS TO REMEMBER

Help young workers to acquire sufficient work experience. It is important to assign older workers to provide on-the-job training and support for young workers before problems become too serious.



Figure 125a. Provide training in dealing with risks at work to young workers, taking into account their background knowledge, skills and physical fitness.

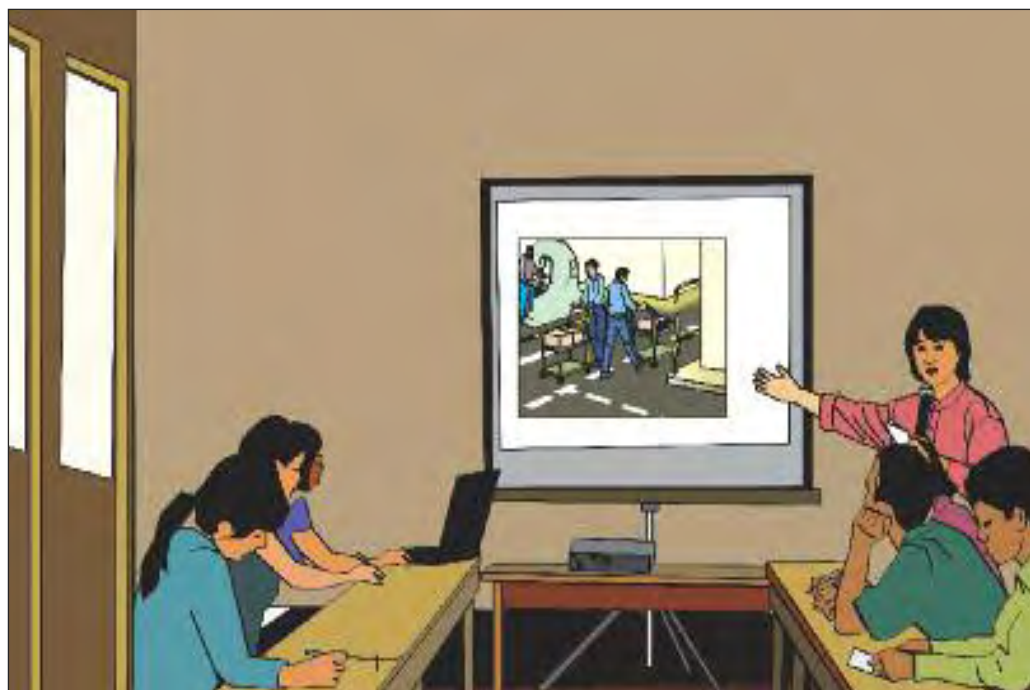

Figure 125b. Provide opportunities for young workers to discuss workplace problems and propose practical improvements reflecting their needs.

CHECKPOINT 126

Adapt facilities and equipment to workers with disabilities so they can do their jobs safely and efficiently.

WHY

Disabled workers can work safely and efficiently if adequate support is provided to meet their needs. This includes disabilities such as mental, auditory, visual and mobility disabilities.

The needs of disabled workers are all different. Some needs can be met by making the equipment and tasks more user-friendly, but there are other individual needs that can be addressed by paying close attention to these needs.

The best way to meet these needs is to organize group discussion about how the workplace can be improved and what the priorities are.

RISKS / SYMPTOMS

- poor worksite access
- muscular strain
- increased injury rates
- poor communication
- lack of acceptance

HOW

1. Organize group discussion about how to meet the special needs of disabled workers. Keep in mind that user-friendly measures can generally help, but that there are also individual needs to be considered.
2. Check various aspects of work, using this manual, to see what improvements at the workplace can solve the problems of disabled workers.
3. Consider not only easy access to and use of work equipment but also easy access to and use of equipment and facilities for workers' general and daily needs, such as movement of people, general instructions and welfare facilities.

4. Organize adequate training about meeting the needs of disabled workers, not only for disabled workers themselves but also for all managers and workers.

SOME MORE HINTS

- Interview both disabled workers and other workers about how to meet the needs of disabled workers. The results can be used for group discussions.
- Flexible work organization is particularly necessary for disabled workers. Discuss possible options in group meetings to find a practical solution.
- Learn from good examples in your own and other workplaces. Discuss these examples to find out whether similar arrangements can be applied.

POINTS TO REMEMBER

By providing adequate support, disabled workers can work safely and efficiently. Organize group discussion involving them and other workers.



Figure 126a. Consider the easy access to and use of equipment and facilities for disabled workers, taking account of their particular needs.



Figure 126b. By providing adequate support, disabled workers can work safely and efficiently.

CHECKPOINT 127

Give due attention to the safety and health of pregnant and nursing women.

WHY

Working conditions should not put the pregnant woman and her unborn child at risk. As women actively participate in all occupations, it is important to make sure that the safety and health of pregnant women are given due attention.

The physical condition of a pregnant woman in the later stages of pregnancy requires special attention. In particular, physically demanding tasks and arduous work, such as night work, must be avoided. Women have different risks at different stages of pregnancy (in particular in the first and last trimesters). Appropriate measures should be taken accordingly.

RISKS / SYMPTOMS

- excessive fatigue
- poor worker health
- muscular strain
- aggravated physical effects

HOW

1. Do not assign pregnant women, especially during the last months of pregnancy, to lifting tasks, transport of loads and other heavy manual tasks.
2. Do not assign pregnant women to night work or other arduous tasks during the last months of pregnancy.
3. Make sure that access and space for movement around machines and equipment, and between workstations, are sufficient to allow easy and comfortable movement of pregnant women.
4. Provide sitting facilities for pregnant women. Do not assign pregnant women to tasks requiring prolonged standing or sitting.

5. Make the tasks assigned to pregnant women, especially in the last months of pregnancy, flexible enough so that they can take adequate rest pauses at work. If necessary, arrange for job rotation so that pregnant women can self-regulate their pace of work.

SOME MORE HINTS

- Where possible, assign pregnant workers to sedentary tasks that are not physically demanding. It is important that pregnant women are not obliged to keep the same work posture all the time.
- Provide sufficient rest periods during the working day for pregnant women.
- Provide adequate welfare facilities at work that pregnant women can comfortably use.

POINTS TO REMEMBER

Pregnant women, especially during the last months of pregnancy, have special needs that should be considered in order to ensure the safety and health of both the mother and the unborn child.



Figure 127a. Make the tasks assigned to pregnant women comfortable and individually adjustable.



Figure 127b. Do not assign pregnant women to tasks requiring heavy manual work or prolonged standing.

CHECKPOINT 128

Take measures so that older workers can perform work safely and efficiently.

WHY

Older workers have knowledge and experience, but may have difficulty in adapting to physically demanding tasks or too fast a pace of work. Adapting work to older workers can improve safety and the flow of work.

Older workers often find it difficult to read instructions and signs written in small characters or presented under dim light. Special care should be taken to make them easy to see.

New technology can make jobs easier for older workers, but may make it difficult for them to adapt to it. Although older workers may be very experienced, they need training in newly introduced technology just like younger workers. However, they may find it difficult to learn in the same way as younger workers.

RISKS / SYMPTOMS

- serious injury or incident
- muscular strain
- poor worker health
- lack of acceptance

HOW

1. Check, together with the workers concerned, whether some tasks may cause difficulty or unsafe conditions for older workers. Discuss how these tasks can be made more adaptable to older workers.
2. Apply mechanical devices for physically demanding tasks involving older workers. Make sure that they are able to accomplish new tasks safely.
3. Make instructions, signs and labels easy for older workers to read.
4. Provide sufficient lighting for older workers. Install local lights, if necessary.

5. Make the pace of work variable between younger and older workers so that older workers can cope more easily with it.
6. When introducing new technologies, consult workers to see what measures are needed to adapt them to both younger and older workers. Training should reflect the needs of older workers to learn at their own pace.

SOME MORE HINTS

- Aside from mechanization, there are a variety of measures to make tasks physically lighter. For example, improving materials handling can greatly help older workers.
- Provide training for older workers on new tasks in a way that is suited to them.
- Group work in which workers can help each other while the pace of work may vary between individuals is a good solution to solve the difficulties that older workers may have.

POINTS TO REMEMBER

Make full use of the knowledge and experience of older workers by adapting work to them. Jobs friendly to older workers are jobs friendly to all.

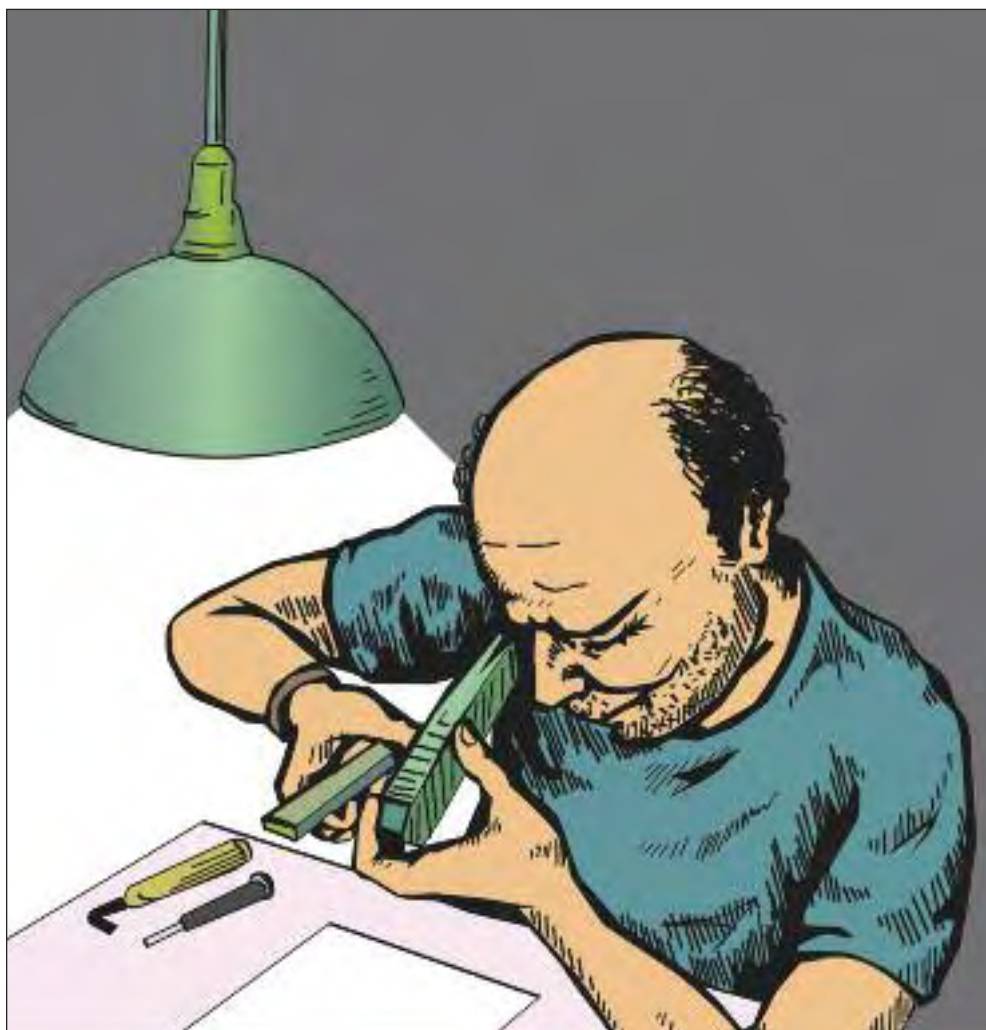

Figure 128. Check, together with older workers, whether some tasks may cause difficulty or unsafe conditions for them.

CHECKPOINT 129

Adjust the workplace to the culture and related preferences of workers by taking a user-centred approach.

WHY

Workers from different cultures may have different responses and preferences concerning workplace conditions. Take into account social and cultural habits and related preferences when organizing work and designing the workplace by consulting workers about the acceptability of workplace conditions.

Work organization can conflict with cultural and social habits. For example, working schedules may be in contradiction with community practices according to culture, or any technology may similarly conflict with prevailing uses among workers. It may be more difficult to adapt to unfamiliar technology because of the lack of background experience in using similar technologies. It is important to involve users in adjusting the technology and the way it is used.

Cultural or social stereotypes may affect workers' intelligibility or capacity to understand displays and signs appropriately. Displays and signs elaborated for a given culture may be inappropriate for workers of different cultures. It is necessary to organize training so that labels, operating instructions, signs and, in general, all written information are understood correctly by particular groups of workers.

Living conditions outside work should be taken into account in improving working life. Work organization should be assessed in relation to these conditions (e.g. reliability of transportation facilities).

Equipment should not conflict with cultural sensitivities. Facilities for prayer and religious rites may need to be provided.

RISKS / SYMPTOMS

- poor understanding
- poor communication
- serious injury or incident
- poor worker health
- stress-induced disorder
- lack of acceptance

HOW

1. Assess the acceptability of the work organization to the workers before implementing it.
2. When introducing a new technology, provide appropriate training and verify workers' comprehension of the new technology and potential hazards.
3. Assess the intelligibility of all written information apparent in the work environment or provided by technical devices. Information should use the language of the workers.
4. Encourage the participation of all workers during introduction of new equipment or methods to identify their needs, preferences and expectations. This also applies to the use of personal protective equipment.
5. Consult workers on their needs for welfare facilities, facilities for prayer and religious rites, taking into consideration their local cultural customs and traditions.

SOME MORE HINTS

- Make sure the needs of workers with different cultures are reflected in the equipment or work methods required.
- Consult workers on their needs for personal protection equipment, taking into consideration their local cultural customs and traditions.
- If possible, use equipment or methods that can be adapted to meet the needs of each worker.

POINTS TO REMEMBER

There may be a number of culturally different groups in the workplace. Make sure that all cultural needs are considered in the design of workplaces and work methods.

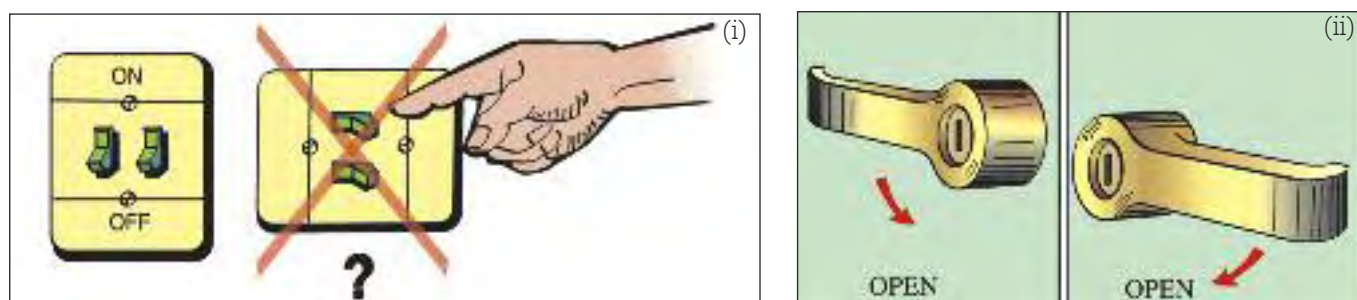

Figure 129a. (i) and (ii) Make signs and controls in the workplace easy to understand by workers from different cultural backgrounds. Where necessary, use simple symbols understood by all workers or add simple words understood commonly or in local languages of the workers concerned. This applies also to door controls or other daily used facilities.



Figure 129b. Formulate suggestions in a way that can be accepted by workers from different cultural backgrounds. Carefully follow up the implementation of proposed measures.

CHECKPOINT 130

Involve both managers and workers in conducting ergonomics-related risk assessment as part of occupational safety and health management systems.

WHY

The implementation of occupational safety and health management systems requires a thorough assessment of risks existing at the workplace. This assessment should clarify whether remaining risks are acceptable or require additional control measures. Ergonomics-related risks constitute an important part of these risks.

Ergonomics-related safety and health risks are various. They concern the way work is done in routine or non-routine conditions. Managers and workers are in the best position to find and implement control measures to reduce the risks.

Continued attention to ergonomics-related risks as part of management duties can contribute greatly to the reduction of occupational injuries and diseases.

RISKS / SYMPTOMS

- increased injury rates
- poor worker health
- aggravated physical effects
- stress-induced disorder
- poor communication
- lack of acceptance

HOW

1. In systematically assessing safety and health risks within occupational safety and health management systems, pay careful attention to a broad range of ergonomics-related risks.
2. Encourage managers and workers to use an action checklist that includes risks relevant to workplace ergonomics.
3. Assess acceptability by the workers of not only the work environment but also work organization, and listen to their views about how to improve existing conditions.
4. When introducing a new technology, provide appropriate training and make sure operators understand any potential hazards.
5. Evaluation of ergonomics-related risks and necessary improvements can be assisted by following the Plan–Do–Check–Act cycle generally applied in occupational safety and health management systems.
6. Reflect the views of managers and workers about existing risks in conducting the audit of risk reduction performance.
7. In assuring a continual process for workplace risk reduction, provide training of managers and workers in assessing and improving ergonomics-related risks as an essential part of their roles in occupational safety and health management systems.

SOME MORE HINTS

- The use of action checklists incorporating ergonomics aspects is recommended, particularly for small enterprises. Guidance in their use should be provided to managers and workers.
- As emphasized by occupational safety and health management systems guidelines, including ILO-OSH 2001, it is important to secure the commitment of management and the participation of the workers. The use of action checklists referring to ergonomics-related risks is recommended in management systems training.
- Use concrete examples of good practices in dealing with ergonomics-related risks so as to facilitate risk management at the workplace. This should include the examples of low-cost improvements achieved in similar local conditions.

POINTS TO REMEMBER

In facilitating risk assessment and necessary improvements as part of occupational safety and management systems, make full use of an action checklist listing practical actions to reduce ergonomics-related risks.

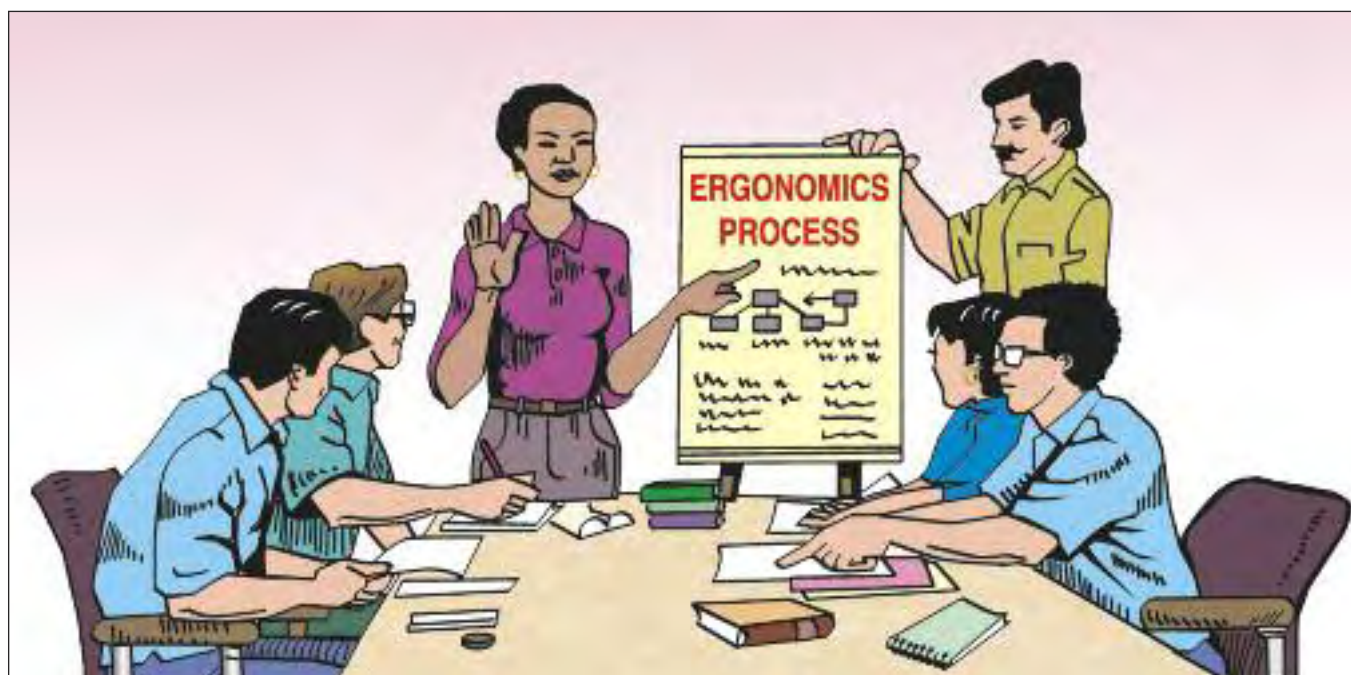

Figure 130a. Form a working group to check and discuss ergonomic problems in your enterprise. The group can learn from locally achieved improvements and propose practical improvements.



Figure 130b. Always include ergonomics-related risks in the discussion of risk assessment and control as an important issue in implementing occupational safety and health management systems.

CHECKPOINT 131

Establish emergency plans to ensure correct emergency operations, easy access to facilities and rapid evacuation.

WHY

An emergency can happen at any time. In order to be prepared, all those concerned should know in advance what to do in an emergency. Emergency plans are essential in any enterprise.

Good emergency plans can minimize the consequences of a potential emergency. They can even prevent a serious accident from occurring.

There are priorities for action in any emergency. It is not easy to recall these priorities when you suddenly face an emergency. People need to be instructed in advance and trained repeatedly to respect these priorities for emergency action.

RISKS / SYMPTOMS

- uncontrolled emergency
- performing wrong operation
- poor communication
- delayed evacuation

HOW

1. Make a reasonable guess about the nature of potential accidents, and identify, by group discussion, types of action that should be taken in each type of emergency. It is especially important to know the likelihood and foreseen consequences of fires, explosions, serious releases of hazardous substances, injuries due to machines and vehicles, and other potential causes of serious injuries such as falls or being struck by objects.
2. Also through group discussion, establish what priority actions should be taken in each type of emergency. These may include emergency operations, shut-down procedures, calling in outside help, first aid and evacuation methods. This discussion must involve supervisors, workers, and safety and health personnel.

3. Make emergency actions and evacuation procedures known to all people concerned. Train repeatedly those who may engage in emergency operations and first aid. Conduct evacuation drills.
4. Make sure that a list of telephone numbers necessary for emergency action is clearly posted and updated. Confirm with all workers that they know where this list is located. Also make sure that all on-site first-aid facilities (e.g. emergency treatment equipment, first-aid boxes, means of transport, protective equipment, etc.) and fire extinguishers are clearly marked and readily accessible.

SOME MORE HINTS

- It is important to plan in advance and make sure everyone knows who will be in charge of emergency activities.
- When there are major changes in production, machinery and hazardous chemicals used, make sure that these changes are reflected in emergency plans.
- An assessment of risks that may affect the surroundings of the enterprise should be included in the emergency plans.

POINTS TO REMEMBER

Everyone in the workplace should know exactly what to do in an emergency situation. Good emergency plans can prevent serious accidents.



Figure 131. Make emergency action plans with the participation of workers.

CHECKPOINT 132

Learn about and share ways to improve your workplace from good examples in your own enterprise or in other enterprises.

WHY

There are many good examples of improvements in your own enterprise or in other enterprises. They represent types of improvement that have been possible under similar local conditions.

The many different problems at the workplace cannot be solved all at once. Progressive improvements are necessary. Here local examples are a good guide, as the benefits of improvements are also visible.

Looking at locally achieved good examples, we can learn about and share ways to improve the use of local materials and skill.

RISKS / SYMPTOMS

- poor communication
- poor understanding
- lack of acceptance
- increased injury or illness rates
- lack of workplace improvement

HOW

1. Check workplaces in your own enterprise and list good examples showing improved work methods or safe and healthy conditions. Simple, low-cost solutions are particularly important. Examine how these improvements were carried out.
2. Visit other enterprises in your neighbourhood, or look at improvement manuals, and learn from good examples.
3. Discuss possible improvements with a group of people. One practical way to do so is through a brainstorming session.
4. Note down, in telegraphic style, kinds of possible improvement that are similar to these good examples and that are relatively inexpensive.

5. Learning from good examples, try to identify feasible solutions. In the discussion, concentrate on solutions that can be carried out immediately, and which are not too idealistic.

SOME MORE HINTS

- Practical training manuals, designed for modern action-oriented training, can also show many good examples of improvements that may be applicable to your local situation.
- Make full use of small-group discussion involving only a few people in finding feasible solutions similar to good examples that you have seen. Looking at slides or video recordings of these good examples will help greatly. Involve workers from the workplace in question in the discussion.
- Beginning with simple, low-cost solutions is always a good policy. As people realize that these low-cost solutions are relatively easy to implement, they are encouraged to start joint action. Keep in mind that most ergonomic solutions are simple in nature and not expensive.

POINTS TO REMEMBER

Local good examples have tremendous power to stimulate our thinking. They show what is possible in local conditions. These good examples are found in your and your neighbours' workplaces.

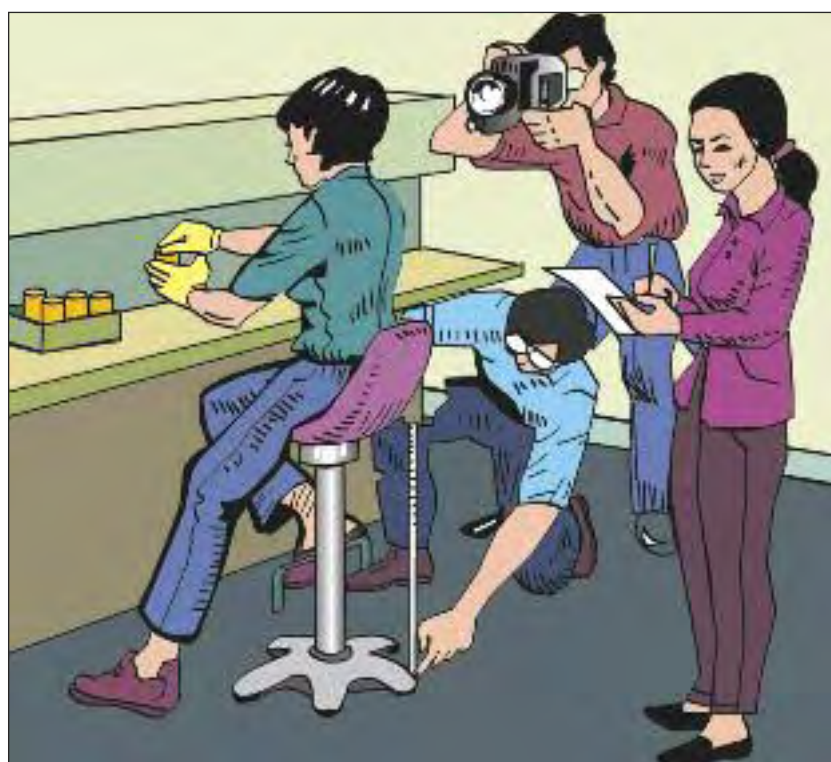

(i)

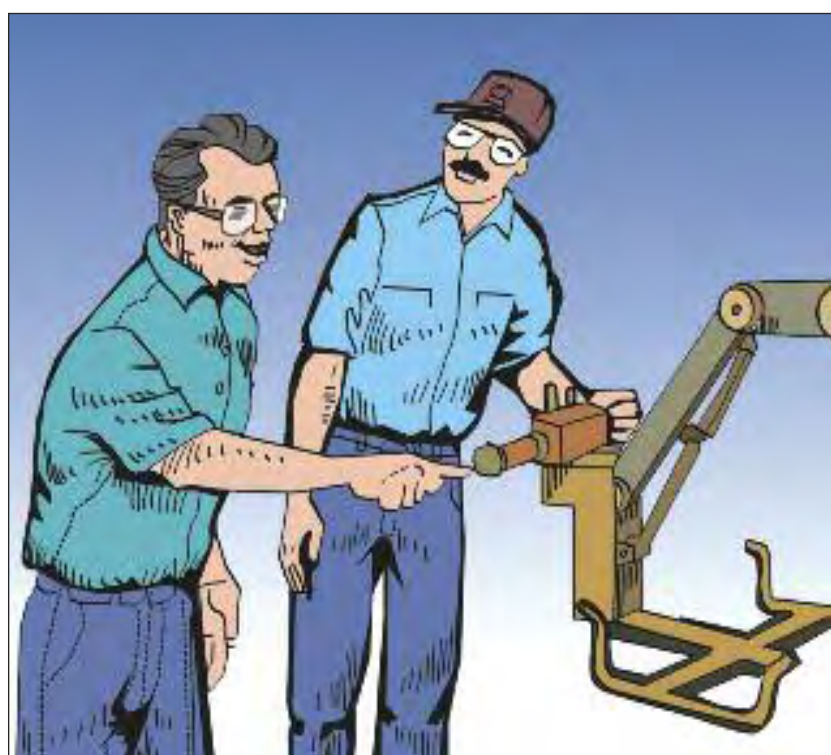

(ii)

Figure 132. (i) and (ii) Organize a group (or groups) to check workplaces in your enterprise, learn from good examples and make joint plans for ergonomic improvements.

Annexes

Samples of locally adapted training materials (See “Suggestions for using the manual”)

Annex 1: Using *Ergonomic checkpoints* in participatory training

Annex 2: Workplace checklist

Annex 3: Practical hints for the workplace checklist

Annex 4: Sample programmes for a training workshop using *Ergonomic checkpoints*

Annex 5: Examples of group work results

Annex 1 Using *Ergonomic checkpoints* in participatory training

Experiences in using *Ergonomic checkpoints* in action-oriented training in improving safety and health at work are accumulating in different countries and industries. This is supported by the awareness that safety and health at work are basic human rights, and that workers should enjoy safer and healthier working conditions. The experiences reported from training activities clearly show the usefulness of training tools making full use of the practical nature of *Ergonomic checkpoints* developed in this manual.

Many training programmes for improving working conditions with the support of *Ergonomic checkpoints* and related training tools have demonstrated the effectiveness of participatory steps involving managers and workers. In particular, training programmes applying the Work Improvement in Small Enterprises (WISE) methodology developed by the ILO and similar participatory methods have led to numerous workplace improvements as suggested by *Ergonomic checkpoints*.

In collaboration with the International Labour Office, participatory training programmes have been held for different target groups. Usually, the courses utilize a set of participatory training tools comprising action checklists, local good examples and improvement manuals referring to available options. The checklists and the manuals reflect the simple, low-cost improvements suggested by *Ergonomic checkpoints*. These programmes include the following:

- training courses for small enterprises applying the WISE methodology in a number of countries in Asia, Latin America and Africa;
- training activities applying the participatory methods similar to those of the WISE methodology in small-scale industrial workplaces, construction sites and home workplaces in Asian countries;
- training workshops for farmers applying the Work Improvement in Neighbourhood Development (WIND) methods originally developed in Viet Nam and implemented in other countries including Kyrgyzstan, the Philippines, Senegal and Thailand;
- training courses for training trade union members in occupational safety and health applying the Participation-oriented Safety Improvement by Trade Union Initiative (POSITIVE) methodology developed by the Japan International Labour Foundation (JILAF) in Bangladesh, China, Indonesia, Mongolia, Nepal, Pakistan, the Philippines, Thailand and Viet Nam.

These programmes are generally based on local good workplace practice. Usually, one- to four-day training programmes are conducted by trained trainers. Training tools used, including action checklists and manuals, are based on local good examples and practical improvement options in line with these examples. The programmes include serial group work by local people. The tasks of the group work are to learn from the local good examples and to plan and implement similarly practicable changes at the workplace. Typical participatory steps include checklist exercise, group discussion of local good examples and basic ergonomic principles, and group work on immediate improvement actions.

The participatory steps are practical and action-oriented. In the initial checklist exercise, participants learn how to use an action checklist adapted to the local situation. Participants are advised to examine existing good points in workplaces instead of merely talking about problems, and to point out practical improvement options. In subsequent technical sessions, trainers present basic improvement principles in a practical way. Because the check items in the action checklist and the basic principles underlying local good examples are those extracted from *Ergonomic checkpoints*, participants are relatively easily guided to understand the ways of improving existing conditions and propose practicable options. Participants' understanding of the principles in different topic areas is reinforced by corresponding illustrations. Group discussions in small groups help participants identify safety and health risks and their solutions. The many manuals developed by trainers of these programmes utilize in various ways the improvement options and illustrations in *Ergonomic checkpoints*.

The technical areas covered by these programmes are similar to those covered by this manual. Usually they include: (1) materials storage and handling, (2) machine safety, (3) workstation design, (4) physical environment, (5) welfare facilities and (6) work organization. Usually, the use of action checklists listing locally practicable improvement actions and the ways to implement practical improvements are learned through group discussions of locally achieved good practices and necessary changes. Presentation of improvement rules and local good examples in the form of illustrations and

photographs can facilitate the learning process. The improvements proposed and implemented by participants frequently reflect the improvement options described on the basis of *Ergonomic checkpoints*.

In this way, the participatory approach suggested in *Ergonomic checkpoints* helps trainers and participants to work constructively in planning and implementing necessary changes. A particular emphasis of training is placed on active cooperation among managers and workers. The group work methods used in these training programmes greatly help participants understand and apply consensus-building techniques through group discussions.

The action checklists used in these programmes are based on the action form described in this manual. The typical checklist widely used in WISE courses consists of 45 check items (8 items on materials storage and handling, 6 items on machine safety, 8 items on workstations, 5 items on lighting, 11 items on control of hazardous substances and agents and on premises, 4 items on welfare facilities and 3 items on work organization). The checklist now used in small construction sites for participatory programmes consists of 45 items (7 items on materials storage and handling, 7 items on work at height, 5 items on work postures, 5 items on machine safety, 7 items on physical environment, 5 items on welfare facilities, 3 items on emergency preparedness, 3 items on work organization and 3 items on safety and health organization). The commonly used WIND checklist comprises 42 items (8 items on materials storage and handling, 7 items on workstation design and work tools, 5 items on machine safety, 9 items on work environment and control of hazardous agents, 8 items on welfare facilities and 5 items on work organization). The POSITIVE action checklist comprises 54 items (8 items on materials handling, 6 items on machine safety, 8 items on workstation changes, 16 items on physical environment, 8 items on welfare facilities, 4 items on environmental protection and 4 items on implementation of improvements). In general, the training materials relying on these checklists thus cover all the main topic areas of *Ergonomic checkpoints*.

The emphasis placed on basic ergonomic principles in all these topic areas is important in facilitating the planning and implementation of immediate improvements. Among others, there are some basic principles useful for this purpose. Examples of these basic ergonomic principles include: organized storage and mobile equipment, easy-reach and elbow-level work, use of fixtures, easy-to-distinguish displays

and controls, machine guarding, mixed use of daylight and lamps, isolation of hazard sources, adequate use of personal protective equipment, essential welfare facilities and teamwork organization.

Numerous improvements reported from the training programmes are low-cost ones and useful for their use in promoting training activities. It is important that low-cost improvements are found in each of the technical areas covered by the programmes. The practical, action-oriented nature of these low-cost improvements is clear from the options presented in this manual, and this is reflected in development of training tools.

In all these training programmes, particular attention is paid to follow-up activities. These follow-up activities are mostly undertaken by the trainers of each programme. They conduct follow-up visits to collect improvement examples and encourage workplace people to continue improvement actions. Follow-up meetings held at intervals are also found useful for encouraging sustainable actions.

The exchange of positive experiences through networking arrangements is also gaining importance. In particular, inter-country networks are playing vital roles in developing improvement databases and stimulating the exchange of training tools and materials. A typical example is the Work Improvement Network in Asia (<http://www.win-asia.org>). The ILO and the IEA are encouraging the development of such networks for exchanging training programmes and tools.

These training experiences clearly point to the practicality and action-oriented style of *Ergonomic checkpoints*. It is hoped that participatory action-oriented training will help increasing numbers of people in various countries to enjoy safer, healthier and more productive work.

As described in the "Suggestions for using the manual" section, examples of training materials developed by some participatory programmes based on this manual are attached as annexes. They include the following:

- Annex 2: Workplace checklist (developed in Malaysia for use in small and medium-sized enterprises);
- Annex 3: Practical hints for the workplace checklist (extracts from a manual corresponding to Annex 2);
- Annex 4: Sample programmes for a training workshop using *Ergonomic checkpoints*; and
- Annex 5: Examples of group work results (from participatory training for trade union members).

Annex 2 Workplace checklist

(From *Practical hints for the workplace checklist*, National Institute of Occupational Safety and Health, Malaysia, 2005)

How to use the checklist

1. Define the work area to be checked.
2. Spend a few minutes walking around the work area.
3. For each action, select NO or YES.
If the action has already been applied, or it is not needed, select NO;
if you propose the action, select YES.
4. Choose a few urgent actions, and tick PRIORITY for these actions.
5. Put your suggestions under REMARKS.

Materials handling

1. Clear and mark transport ways.



Do you propose action?

NO YES PRIORITY

Remarks

2. Provide multi-level racks near the work area for materials, tools and products.



Do you propose action?

NO YES PRIORITY

Remarks

3. Use carts, hand-trucks and mobile racks when moving materials.

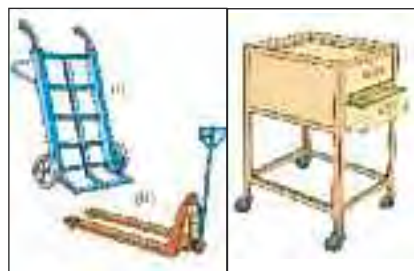

Do you propose action?

NO YES PRIORITY

Remarks

4. Instead of carrying heavy weights, divide them into smaller lightweight packages, containers or trays.



Do you propose action?

NO YES PRIORITY

Remarks



5. Use lifting devices or lift-trucks for lifting heavy materials.

Do you propose action?

NO YES PRIORITY

Remarks



6. Provide good grips or holding points for all containers and packages.

Do you propose action?

NO YES PRIORITY

Remarks

Workstations



7. Adjust working height at elbow level (if necessary, use foot platforms for small workers and work item holders for tall workers).

Do you propose action?

NO YES PRIORITY

Remarks



8. Put frequently used materials in small containers placed within easy reach from normal working position.

Do you propose action?

NO YES PRIORITY

Remarks

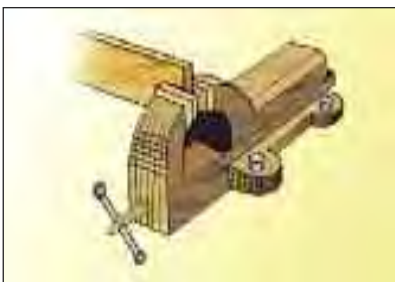

9. Use clamps, jigs and other fixtures to hold items while work is done.

Do you propose action?

NO YES PRIORITY

Remarks



10. Use hanging tools or conveniently fixed tools for operations repeated at the same place.

Do you propose action?

NO YES PRIORITY

Remarks _____



11. Provide standing workers with conveniently placed chairs or stools for occasional sitting.

Do you propose action?

NO YES PRIORITY

Remarks _____



12. Provide chairs of correct height (with both the feet flatly placed on the floor) and with a good backrest.

Do you propose action?

NO YES PRIORITY

Remarks _____



13. Attach simply worded labels and use colours so as to avoid mistakes.

Do you propose action?

NO YES PRIORITY

Remarks _____



14. Introduce a work-rotation system to avoid repetition of the same types of work.

Do you propose action?

NO YES PRIORITY

Remarks _____

Teamwork environment



15. Provide sufficient lighting for workers by repositioning lights or providing task lights for precision work.

Do you propose action?

NO YES PRIORITY

Remarks _____

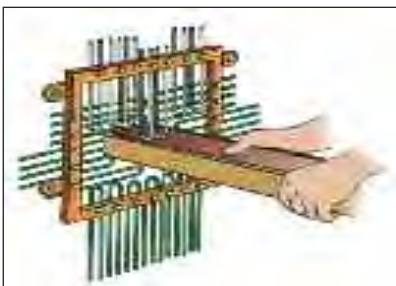

16. Attach proper guards or interlocking devices to avoid contact with moving parts of machines.

Do you propose action?

NO YES PRIORITY

Remarks _____



17. Use safety devices that prevent operations of machines while the worker's hands are in danger.

Do you propose action?

NO YES PRIORITY

Remarks _____



18. Label containers of hazardous chemicals and store them in appropriate places.

Do you propose action?

NO YES PRIORITY

Remarks _____

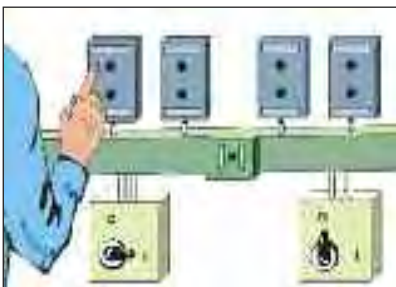

19. Ensure safe wiring connections for supplying electricity to equipment.

Do you propose action?

NO YES PRIORITY

Remarks _____



20. Clearly designate and mark areas requiring the use of protective equipment, and make sure everyone uses it there.

Do you propose action?

NO YES PRIORITY

Remarks _____



21. Provide rest corners with comfortable facilities and refreshing drinks.

Do you propose action?

NO YES PRIORITY

Remarks _____

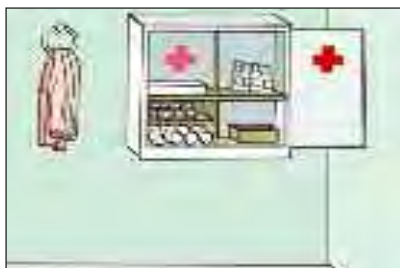

22. Provide first-aid equipment near the workplace, and train a qualified first-aid-er.

Do you propose action?

NO YES PRIORITY

Remarks _____



23. Provide opportunities to take short breaks for repetitive or arduous work.

Do you propose action?

NO YES PRIORITY

Remarks _____



24. Rearrange layout and the order of operations to improve production flow.

Do you propose action?

NO YES PRIORITY

Remarks _____

Date: / /	Notes
Workplace:	
Checker:	

Annex 3 Practical hints for the workplace checklist

(Extracts from *Practical hints for the workplace checklist*, National Institute of Occupational Safety and Health, Malaysia, 2005)

Checkpoint 1

Clear and mark transport ways.

- Define transport routes as distinct from work areas, remove obstacles, and install floor markings using paint on both edges of each transport route.
- Provide fences where needed.
- Make sure that proper places for storage and waste disposal are present.



Keep aisles and corridors wide enough to allow two-way transport.



Draw lines to separate transport areas from working areas and keep the areas clear.



Lines drawn to separate transport routes and storage areas from working areas.



Point to remember

Marking transport routes is the starting point for keeping them clear of obstacles. Clear transport routes are maintained better when combined with good storage places.

Checkpoint 2

Provide multi-level racks near the work area for materials, tools and products.

- Provide multi-level, open-fronted shelves or racks for various specific items.
- You can make full use of wall space by fitting such racks.
- It is recommended to provide a specially arranged place for each kind of material or part so that access to it is easy.
- Use labels to indicate each specific place. Avoid levels that are too high or too low.



A vertical rack. Tray-type shelves provide room for small pieces.



Shelving designed to use wall space fully.



Multi-level shelves and racks placed near the workplace.



Point to remember

Multi-level shelves and racks near the workplace save a great deal of time and space. They keep things in good order. This helps reduce accidents and damage to materials.

Checkpoint 8

Put frequently used materials in small containers placed within easy reach from normal working position.

- Place frequently used tools and controls within the primary hand movement area (within around 40 cm from the front and the side of the body at elbow height).
- Place all frequently used materials (often in boxes, pallets or racks) within the primary hand movement area or at the margin of this area.
- For similar workstations, organize the placing of tools, controls and materials in a good combination with each other.
- Tools or materials used only occasionally may be placed at a more distant location.



Place frequently used materials, tools and controls within easy reach.



Multi-level shelves and racks placed near the workplace.



Point to remember

Frequently used materials, tools and controls placed within easy reach can greatly save time and energy. This easy-reach area is quite narrow and should be tried out.

Checkpoint 13

Attach simply worded labels and use colours so as to avoid mistakes.

- Attach simply worded labels or signs to displays and controls so as to avoid wrong operation. Labels and signs must be large and clear enough to be easily read.
- Put labels or signs for displays and controls immediately above, underneath or to the side so that it is clear which label or sign corresponds to which display or control.
- Where appropriate, use different colours for different labels, signs or controls.
- Make the message clear and short. Confusing and lengthy text must be avoided.
- Make sure that labels and signs use the language understood by the workers. When there is more than one language group, use different languages in labels and signs.



Labels and signs should be easy to see and easy to read.



Warning signs should use short messages that indicate the nature and gravity of the hazards.



Simply worded labels and colours for distinguishing different controls from each other.

Point to remember

Labels and signs located properly can reduce errors and save time. Make them large enough, and make the message short and easy to understand.

Checkpoint 19

Ensure safe wiring connections for supplying electricity to equipment.

- Insulate or guard electrical connections. Ensure that all wirings are appropriate.
- Provide a sufficient number of socket outlets in order to minimize contacts of workers with cables. If necessary, use multi-plug sockets or overhead outlets.
- Protect cables from spillages.
- Make it a rule to replace frayed cables quickly.
- Provide proper grounding for machines and equipment.
- Train all workers about how to work safely with electrical circuits and connections.

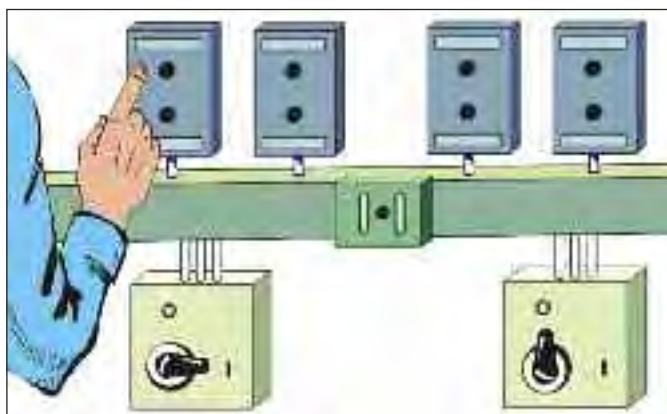

Keeping wiring and electrical connections well maintained can minimize lost work time due to equipment failure.



Safe wiring and electrical connections prevent accidents and fires.

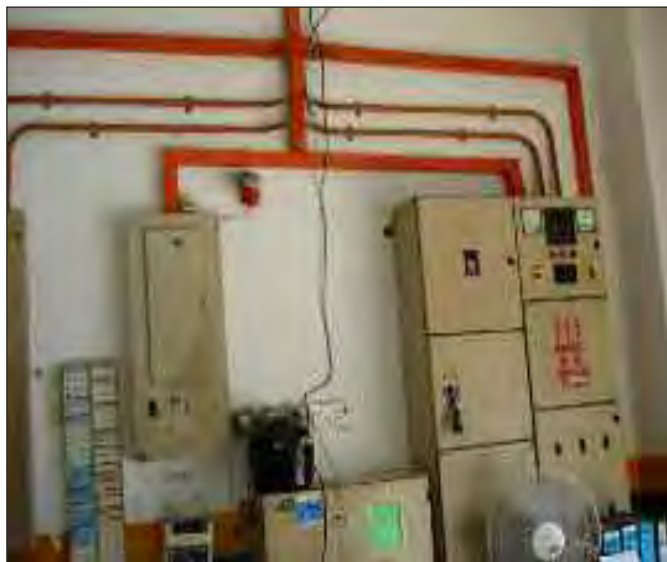

Safe wiring connections for supplying electricity to equipment.

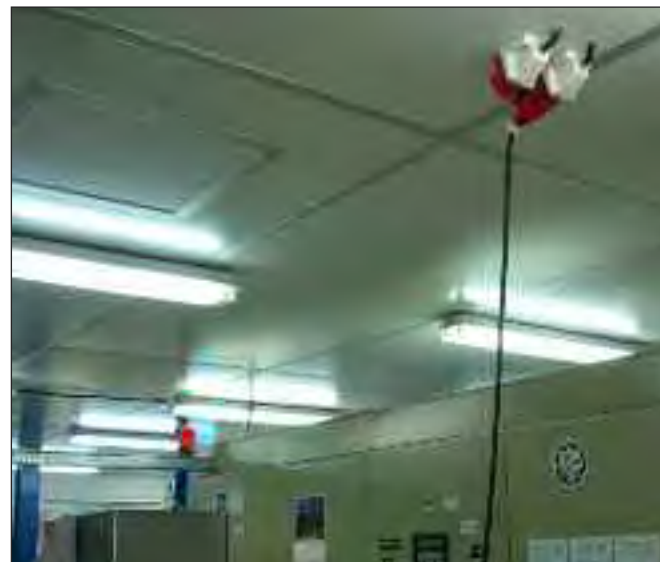

Point to remember

Safe wiring and electrical connections result in less chances of fires and time lost due to machine failures and injury of workers.

Checkpoint 21

Provide rest corners with comfortable facilities and refreshing drinks.

- Provide rest corners or rooms separate from work areas and free from disturbances such as noise, dust and chemicals.
- Provide comfortable facilities for relaxation during rest. As a minimum, a table and chairs or sofas are needed. Maintain hygienic conditions of all these facilities.
- Provide easy access to clean washing and drinking water or other refreshing drinks.
- Keep a relaxing atmosphere by a good location, proper ventilation or green plants.

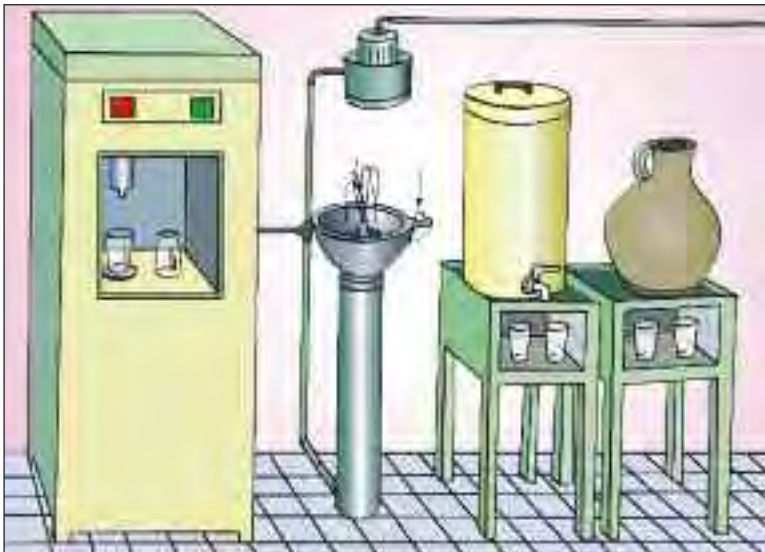

Ways of providing cool, clean water.



Rest corners near the work area.

Point to remember

Choose relaxing types of rest corners suited to your workplace, and maintain clean and hygienic conditions with comfortable facilities and refreshing drinks.

Annex 4 Sample programmes for a training workshop using *Ergonomic checkpoints*

A. Two-day workshop

Day 1

08.00–08.30	Registration
08.30–08.50	Opening session
08.50–10.40	Session 1: Checklist exercise (Introduction, visit to a factory, group discussion and presentation)
10.40–11.00	Tea break
11.00–12.00	Session 2: Materials storage and handling (Trainer presentation, group discussion and presentation)
12.00–13.30	Lunch break
13.30–15.00	Session 3: Tool and machine safety (Trainer presentation, group discussion and presentation)
15.00–15.20	Tea break
15.20–16.50	Session 4: Workstation design (Trainer presentation, group discussion and presentation)
16.50–17.00	Summary of Day 1

Day 2

08.30–10.00	Session 5: Physical environment (Trainer presentation, group discussion and presentation)
10.00–10.20	Tea break
10.20–11.50	Session 6: Welfare facilities and work organization (Trainer presentation, group discussion and presentation)
11.50–12.00	Photo contest (Voting by participants)
12.00–13.30	Lunch break
13.30–15.00	Session 7: Implementation of improvements (Trainer presentation, group discussion and presentation)
15.00–15.20	Tea break
15.00–15.30	Session 8: Setting up of individual action plans
15.30–16.00	General discussion
16.00–16.10	Summary of Day 2
16.10–16.30	Evaluation of the training
16.30–17.00	Giving certificates to participants Impressions of participants Closing

B. Four-day workshop

Day 1

08:00–09:00	Registration
09:00–09:30	Opening
09:30–09:50	Self-introduction
09:50–10:30	Orientation to the training workshop
10:30–10:50	Tea break
10:50–12:00	Trends in ergonomic workplace improvement
12:00–13:30	Lunch break
13:30–15:30	Session 1: Factory visit with checklist exercise
13:30–14:00	Transport to a factory
14:00–15:00	Checklist exercise by walk-through
15:00–15:30	Transport back to training venue
15:30–16:00	Tea break
16:00–17:00	Session 1 (continued)
16:00–16:30	Group discussion of the checklist results
16:30–17:00	Group presentation and general discussion

Day 2

08:30–10:10	Session 2: Material storage and handling
08:30–09:00	Trainer presentation
09:00–09:40	Group discussion
09:40–10:10	Group presentation
10:10–10:30	Tea break
10:30–12:00	Session 3: Machine safety
10:30–11:00	Trainer presentation
11:00–11:30	Group discussion
11:30–12:00	Group presentation and general discussion
12:00–13:30	Lunch break
13:30–15:00	Reports from participants on experiences in safety and health
15:00–15:20	Tea break
15:20–17:00	Session 4: Workstation design
15:20–15:50	Trainer presentation
15:50–16:30	Group discussion
16:30–17:00	Group presentation and general discussion

Day 3

- 08:30–10:10 **Session 5: Physical environment**
- 08:30–09:00 Trainer presentation
 - 09:00–09:40 Group discussion
 - 09:40–10:10 Group presentation
- 10:10–10:30 Tea break
- 10:30–12:00 **Session 6: Welfare facilities**
- 10:30–11:00 Trainer presentation
 - 11:00–11:30 Group discussion
 - 11:30–12:00 Group presentation and general discussion
- 12:00–13:30 Lunch break
- 13:30–15:00 Training skills and methods
- 15:00–15:20 Tea break
- 15:20–17:00 **Session 7: Work organization**
- 15:20–15:50 Trainer presentation
 - 15:50–16:30 Group discussion
 - 16:30–17:00 Group presentation and general discussion

Day 4

- 08:30–10:10 **Session 8: Implementation of improvements**
- 08:30–09:00 Trainer presentation
 - 09:00–09:40 Group discussion
 - 09:40–10:10 Group presentation
- 10:10–10:30 Tea break
- 10:30–12:00 **Session 9: Development of final proposals**
- 10:30–10:45 Orientation to the final proposals
 - 10:45–11:15 Group discussion
 - 11:15–11:40 Group presentation
 - 11:40–12:00 Feedback from managers and general discussion
- 12:00–13:30 Lunch break
- 13:30–15:30 **Session 10: Future work plans**
- 13:30–13:50 Orientation to the session
 - 13:50–14:30 Development of individual work plans
 - 14:30–15:30 Presentation of individual work plans
- 15:30–15:50 Tea break
- 15:50–16:20 General discussion and feedback from participants
- 16:20–16:40 Evaluation of the workshop
- 16:40–17:00 Closing

Annex 5 Examples of group work results

(From *POSITIVE programme: Trainers' manual for occupational safety and health*, Japan International Labour Foundation, 2002)

Group work results about the five technical areas of a factory

Technical areas	Three good points	Three points to be improved
Materials handling	<ol style="list-style-type: none"> 1. Clear passageways 2. Carts and hand trolleys 3. Organized storage system 	<ol style="list-style-type: none"> 1. Mobile storage trolleys should be introduced 2. More mechanical aids for materials loading 3. Multi-level racks for chemical storage
Machine safety	<ol style="list-style-type: none"> 1. Proper machine guards 2. Clear instructions for safe machine operations 3. Emergency stop switches in place 	<ol style="list-style-type: none"> 1. Chains and gears should be covered in the folding section 2. Clear labels and signs are needed on some machines 3. More feeder systems should be introduced
Workstation design	<ol style="list-style-type: none"> 1. Working at elbow height in the garment section 2. Tools and switches placed within easy reach of workers 3. Chutes for collecting wastes 	<ol style="list-style-type: none"> 1. Seating arrangements for standing workers 2. Work height in the cutting section should be adjusted to elbow height 3. Use more fixtures for holding materials
Physical environment	<ol style="list-style-type: none"> 1. Full use of skylights and artificial lighting 2. Natural ventilation and exhaust fans 3. Proper storage of chemical containers 	<ol style="list-style-type: none"> 1. Installing local lights in the garment section 2. Proper lids should be attached to all chemical cans and containers 3. Ventilation of the chemical storage place should be increased
Welfare facilities	<ol style="list-style-type: none"> 1. Rest corners in the garment section 2. Sufficient number of toilets 3. Drinking water facilities in work areas 	<ol style="list-style-type: none"> 1. First-aid boxes in the work areas 2. Changing rooms and lockers, especially for women workers 3. Some recreation facilities
Work organization	<ol style="list-style-type: none"> 1. Short breaks in the morning and in the afternoon 2. Safety awards 3. Emergency evacuation plans posted 	<ol style="list-style-type: none"> 1. Rotation schemes for certain jobs 2. Training of managers and migrant workers 3. Improved design of workstations should be undertaken by involving workers

ERGONOMIC CHECKPOINTS

Second edition

Fully revised and expanded, this new edition of the highly successful *Ergonomic checkpoints* is aimed at reducing work-related accidents and diseases and improving safety, health and working conditions. Building on the wealth of experience of practitioners in applying these checkpoints, the second edition features revised text, additional checkpoints and new, full-colour illustrations.

The manual presents 132 realistic and flexible solutions to ergonomic problems applicable across a whole range of workplace situations, including:

- ✓ Materials storage and handling
- ✓ Hand tools
- ✓ Machine safety
- ✓ Workstation design
- ✓ Lighting
- ✓ Premises
- ✓ Control of hazardous substances and agents
- ✓ Welfare facilities
- ✓ Work organization

Each of the illustrated checkpoints indicates an action, why it is necessary and how to carry it out, and provides further hints and points to remember. A template checklist is also included, which can be adapted to individual workplaces.

The manual is designed for use by all who are concerned with creating a better workplace: employers, supervisors, workers, inspectors, safety and health personnel, trainers and educators, extension workers, engineers, ergonomists and designers.

ISBN 978-92-2-122666-6



9 789221 226666