

2018 NFPA 70E

ELECTRICAL SAFETY-RELATED WORK PRACTICES PACKET

INLAND EMPIRE ELECTRICAL JATC

1855 Business Center Drive
San Bernardino CA 92408
Telephone: 989-890-1703



2017-2018 EDITION



Answer yes or no to the following questions

1. The fundamental premise of NFPA 70E is that a qualified person must decide whether work can be performed energized.
2. Journeyman electricians are considered a qualified person based on the definition in NFPA 70E.
3. The arc flash boundary (AFB) can be greater than the limited approach boundary (LAB).
4. An arc flash hazard analysis may be performed using an incident energy (calculation) method or the hazard/risk category (table) method using Table 130.7(C)(15)(a) for alternating current and Table 130.7(C)(15)(b) for direct current.
5. OSHA can cite employees for failure to comply with a section of NFPA 70E.

Don't know the answers to these questions?



Don't worry you will by the end of this class!

TERMS

2012 edition	2015 edition
Harm	Injury or damage to health
Work shoes	Footwear
Arc flash hazard analysis	Arc flash risk assessment
Shock hazard analysis	Shock risk assessment
Electrical hazard analysis	Electrical hazard risk assessment
Hazard/risk category	Arc flash PPE category
Hazard identification and risk assessment	Risk assessment
Probability	Likelihood

Upon completion of this course you should be able to:

- 1) Understand why 70E training is necessary
- 2) Understand why it is necessary to be OSHA and 70E compliant
- 3) Understand the new requirement in the NEC and NFPA 70E
- 4) Understand the Limited approach boundaries of electrical shock, arc-flash and arc-blast
- 5) Know how to read the Arc Flash/ electrical shock labels
- 6) Know the right category PPE and how to wear it properly
- 7) Understand Simple and Complex Lock-Out Tag -Out Procedures
- 8) Understand how to fill out a job briefing form
- 9) Know when a "Live Work Permit" is needed and how to fill it out

The Electrical Safe Work Practice Standards have not changed:

OSHA is the SHALL

and

NFPA 70E is the HOW

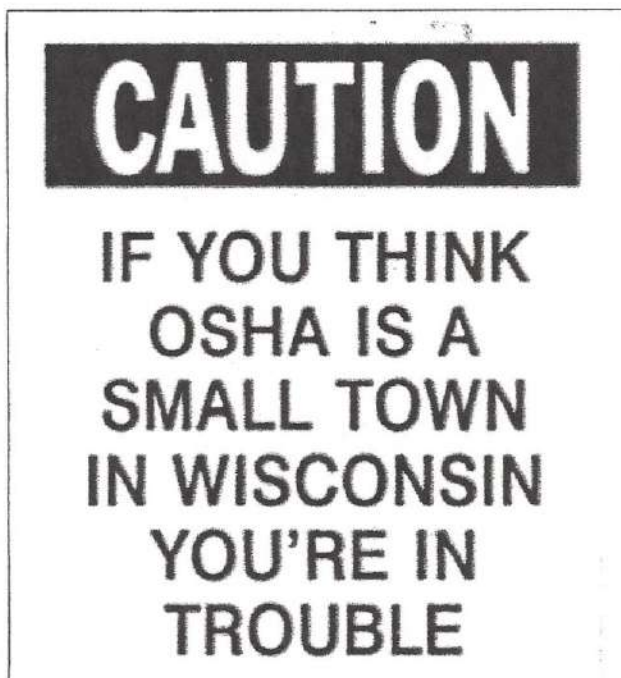

Changes for the 2015 NFPA 70E

What's new?

Some of the terminology used during this revision cycle has changed. Request for Proposals are now called Public Input (PI), and this revision cycle had 448 PIs. The Report on Proposals (ROP) is now called the First Draft, and what was previously called the Report on Comments (ROC) is referred to as the Second Draft.

The changes this article outlines are based on what was known at the time of writing. It does not include every change made, and much of the language is paraphrased due to space limitations. Since the NFPA Standards Council has not formally approved the final document, there is always the possibility of additional changes. Therefore, always refer to the final approved version when it is published.

Global changes

Several terms used throughout NFPA 70E have been changed for the 2015 edition. The left column in the terms table above refers to the term used in the 2012 edition and the right column lists the new corresponding term for 2015.

Please note: all references to hazard/risk category (HRC) have been deleted throughout the standard. Arc flash PPE category is the revised term.

Article 90 Introduction

90.2 Scope

90.2(A) Covered: The words "safety-related maintenance requirements, and other administrative controls" have been added to what is covered to emphasize the importance of maintenance.

90.2(B) Not Covered: The reference to "Installations underground in mines and self-propelled mobile surface mining machinery and its attendant electrical trailing cable" has been deleted from the not covered section, meaning it is now covered.

Article 100 Definitions

DELETED DEFINITIONS

Bare-hand work: This definition has been deleted.

Prohibited approach boundary: All references to the prohibited approach boundary have been deleted throughout the 2015 edition. Once the restricted approach boundary was crossed, there were no other requirements.

Changes for the 2015 NFPA 70E

REVISED DEFINITIONS

Restricted approach boundary: The word “risk” has been replaced by “likelihood.”

Incident energy: This definition now references thermal energy instead of just energy.

Qualified person: This definition changed from “one who has the skills and knowledge” to “one who has demonstrated the skills and knowledge.” Also the word “recognize” has been changed to “identify and avoid the hazards.”

NEW DEFINITIONS

Hazard: A source of possible injury or damage to health

Hazardous: Involving exposure to at least one hazard

Risk: Refers to a combination of both the likelihood of injury occurrence and the severity

Risk assessment: A process that identifies the hazards, estimates the potential severity of injury or damage to health, estimates the likelihood of the injury occurrence or damage to health, and determines if protective measures are required

Article 110 General Requirements for Electrical Safety-Related Work Practices

This article was reorganized by moving Section 110.3 Electrical Safety Program to 110.1 and moving 110.1 Relationships with Contractors (renamed Host and Contract Employers Responsibilities) to Section 110.3.

The order is now 110.1 Electrical Safety Program, 110.2 Training Requirements, and 110.3 Host and Contract Employers Responsibilities.

110.1 ELECTRICAL SAFETY PROGRAMS

110.1(A) General: The language “activity appropriate for the electrical hazards” has been changed to “activity appropriate to the risk associated with electrical hazards.”

110.1(B) Maintenance: This new addition states that “The electrical safety program shall include elements that consider condition of maintenance of electrical equipment and systems.” The addition of this new section means that subsequent sections are renumbered.

110.1(F) Electrical Safety Program Procedures: The reference to both the limited approach boundary and arc flash boundary has been deleted. New language

Changes for the 2015 NFPA 70E

emphasizes that “An electrical safety program shall identify the procedures to be utilized before work is started by employees exposed to an electrical hazard.”

110.1(G) Risk Assessment Procedure: The title was changed to align with the emphasis on risk assessment. The reference to limited approach boundary and arc flash boundary was deleted.

110.2 TRAINING REQUIREMENTS

110.2(A) Safety Training: New language was added to emphasize the element of risk. It reads, “when the risk associated with that hazard is not reduced to a safe level.”

110.2(C) Emergency Response Training: This section was renamed and subdivided into four parts.

(1) Contact Release: This section now requires annual refresher training.

(2) First Aid, Emergency Response and Resuscitation: New language now requires annual refresher training for cardiopulmonary resuscitation (CPR) and automated external defibrillator (AED). This changed the existing language that required annual certification by the employer.

(3) Training Verification: New language requires that “Employers shall verify at least annually that employee training required by this section is current.”

(4) Documentation: “The employer shall document that the training required by this section has occurred.”

110.2(D)(1) Qualified Person

110.2 (D)(1)(b)(4): The decision-making process was converted to a list of four items that includes the following:

“i) Perform the job safety planning ii) Identify electrical hazards iii) Assess the associated risk iv) Select the appropriate risk control methods from the hierarchy of controls identified in 110.1(G) including selecting the personal protective equipment.”

110.2(D)(1)(e): The term “voltage detector” was replaced with “test instrument.”

110.2(E) Training Documentation

Informational Note No. 1: A new informational note states that the training content could be one or more of the following: the syllabus, curriculum outline, table of contents or training objectives.

Changes for the 2015 NFPA 70E

110.3 HOST AND CONTRACT EMPLOYERS' RESPONSIBILITIES

110.3: The title of this section was changed from "Relationships with Contractors."

110.3(C) Documentation: New text was added to this section: "Where the host employer has knowledge of hazards covered by this standard that are related to the contract employer's work," there shall be a documented meeting between the host employer and the contract employer.

110.4 USE OF ELECTRICAL EQUIPMENT

110.4(C) Ground-Fault Interrupter (GFCI) Protection

(2) Maintenance and Construction: This new section states, "GFCI protection shall be provided for operating or using cord and plug connected tools related to maintenance and construction activity supplied by 125 volt, 15, 20, or 30 ampere circuits. Where employees operate or use equipment supplied by greater than 125 volt, 15, 20, or 30 ampere circuits either GFCI protection or an assured equipment grounding conductor program shall be implemented."

Article 120 Establishing an Electrically Safe Work Condition

120.1 Verification of an Electrically Safe Work Condition: The title was changed from "Process of Achieving an Electrically Safe Work Condition."

(5): The term "rated voltage detector" was changed to "rated test instrument" and "through verification on a known voltage source" was added to verify the test instrument is operating satisfactorily.

120.2(B) PRINCIPLES OF LOCKOUT/TAGOUT EXECUTION

120.2(B)(3) Retraining: Retraining shall be at intervals not exceeding three years. This rule has been added to the existing language, which also requires retraining when the procedure is revised.

120.2(B)(4) Training Documentation: This new addition requires documenting when each employee receives training required by this section. The documentation shall be made when the employee demonstrates proficiency in work practices involved, and the documentation shall contain the content of the training, the employee's name and dates of the training.

120.2(E)(4)(e): Additional language was added regarding hold cards. Now a method of accounting for personnel who are working under the protection of the hold card must be included.

Changes for the 2015 NFPA 70E

120.3(A) Temporary Protective Grounding Equipment: New text states that the location, sizing and application of temporary protective grounding equipment shall be identified as part of the employer's job planning.

Article 130 Work Involving Electrical Hazards

130.1 General: New language clarifies what Article 130 covers, including the following:

1. When an electrically safe work condition must be established
2. The electrical safety-related work practices when an electrically safe work condition cannot be established

130.2(A)(4) Normal Operation: The word "interaction" can still cause some confusion regarding work practices. This new section states that normal operation of electric equipment shall be permitted where all of the following conditions regarding the equipment are satisfied:

1. The equipment is properly installed.
2. The equipment is properly maintained.
3. All equipment doors are closed and secured.
4. All equipment covers are in place and secured.
5. There is no evidence of impending failure.

130.2(B) ENERGIZED ELECTRICAL WORK PERMIT

130.2(B)(1) When Required: References to the limited approach and arc flash boundaries have been deleted, and the new language states, "When energized work is permitted in accordance with 130.2(A) an energized electrical work permit (EEWP) is required under the following conditions:

"(1) When work is performed within the restricted approach boundary or

"(2) When the employee interacts with the equipment when conductors or circuit parts are not exposed but an increased likelihood of injury from an exposure to an arc flash exists."

130.2(B)(2) Elements of Work Permit: This section now requires the results of the shock risk assessment rather than shock hazard analysis and must include the voltage to which personnel will be exposed. "Arc flash hazard analysis" was changed to "arc

Changes for the 2015 NFPA 70E

flash risk assessment,” and the working distance must now be included if the incident energy is provided.

130.2(B)(3) Exemptions to Work Permit: This section was reworded and includes the following exceptions:

- Testing, troubleshooting and voltage measuring
- Thermography and visual inspection if the restricted approach boundary (RAB) is not crossed
- Access/egress from an area with energized electrical equipment with no electrical work and the RAB is not crossed
- General housekeeping and miscellaneous nonelectrical tasks if the RAB is not crossed.

130.4 ASSESSMENT AND APPROACH BOUNDARIES

130.4(A) Shock Risk Assessment: The title was changed from “Shock Hazard Analysis.”

Table 130.4(C)(a) Approach Boundaries to Energized Electrical Conductors: The prohibited approach boundary was deleted from the table. The second row was changed from 50V–300V to 50V–150V, and the third row was changed from 301V–750V to 151V–750V.

130.5 ARC FLASH RISK ASSESSMENT

The title was changed from “Arc Flash Hazard Analysis.” The arc flash risk assessment shall determine if the arc flash hazard exists. If it does, the risk assessment shall determine the appropriate safety-related work practices, the arc flash boundary and the personal protective equipment (PPE) to be used within the arc flash boundary.

Informational Note No.1: New language was added to this informational note that states: “Where equipment is not properly installed or properly maintained, PPE selection based upon incident energy analysis or the PPE category method may not provide adequate protection from arc flash hazards.”

130.5(A) Documentation: This new section requires the results of the arc flash risk assessment to be documented.

130.5(B) Arc Flash Boundary: In addition to the existing definition of the arc flash boundary being the distance where the incident energy equals 1.2 cal/cm², new language has been added permitting the arc flash boundary to be determined by Table

Changes for the 2015 NFPA 70E

130.7(C)(15)(A)(b) or Table 130.7(C)(15)(B) when the requirements of the tables apply.

130.5(C) Arc Flash PPE: New text emphasizes that only one method shall be used for selecting PPE at the same piece of equipment. These methods include either the results of an incident energy analysis or the arc flash PPE category method but not both. Language was also added to specifically prohibit using the results of an incident energy analysis to specify an arc flash PPE category in Table 130.7(C)(16).

130.5(D) Equipment Labeling: The arc flash labeling requirements still include the nominal system voltage and arc flash boundary as in the past. However, new language further clarifies how to label the PPE requirements.

The revised language states at least one of the following:

- Either the available incident energy with the corresponding working distance or the arc flash PPE category in Table 130.7(C)(15)(A)(b) or Table 130.7(C)(15)(B) shall be listed but not both.
- Minimum arc rating of clothing is required.
- Site-specific level of PPE is required.

This section now specifies that the owner of the electrical equipment is responsible for the documentation, installation and maintenance of the field-marked label.

130.7(C)(15) SELECTION OF PERSONAL PROTECTIVE EQUIPMENT (PPE) WHEN REQUIRED FOR VARIOUS TASKS

Table 130.7(C)(15)(A)(a) Arc Flash Hazard Identification for Alternating Current (AC) and Direct Current (DC) Systems: This new table is used for determining when arc flash PPE is required for both AC and DC electrical systems. The tables use a simple yes or no if arc flash PPE is required and are based on the task to be performed and the equipment condition. Equipment condition parameters include whether the equipment is properly installed and maintained, all equipment doors are closed and secured, covers are in place and secured, and there is evidence of impending failure.

New PPE Category Tables—General Comment: New tables have been developed based on the PPE category. The hazard/risk references have been deleted. Category 0 and the columns for rubber gloves and insulated tools have been deleted. Some of the arc flash boundaries have been rounded to the nearest foot.

Table 130.7(C)(15)(A)(b)—Arc Flash Hazard PPE Categories for Alternating Current (AC) Systems: This table defines the PPE categories for AC systems. Specific

Changes for the 2015 NFPA 70E

tasks have been deleted, and it now lists equipment, arc flash PPE category and the arc flash boundary.

Table 130.7(C)(15)(B)—Arc Flash Hazard PPE Categories for Direct Current (DC) Systems: This table defines the PPE categories for DC systems. Specific tasks have been deleted, and it now lists equipment, arc flash PPE category and the arc flash boundary.

130.7(D)(1) Insulated Tools and Equipment: This section now references the restricted approach boundary instead of the limited approach boundary and applies when working inside the restricted approach boundary of exposed energized electrical conductors or circuit parts where tools or handling equipment might make accidental contact.

130.7(E)(2) Barricades: This section now includes the arc flash boundary. Barricades shall be placed at the greater of the limited approach boundary or the arc flash boundary.

Chapter 2 Safety-Related Maintenance Requirements

Article 200 INTRODUCTION

200.1 Scope: Informational Note No. 3 now references IEEE 3007.2—IEEE Recommended Practice for the Maintenance of Industrial and Commercial Power Systems.

205.3 General Maintenance Requirements: This expanded section includes new language that states, “The equipment owner or the owner’s designated representative shall be responsible for maintenance of the electrical equipment and documentation.”

A new informational note regarding text and calibration labels was added that states, “Common industry practice is to apply test or calibration decals to equipment to indicate the test or calibration date and overall condition of equipment that has been tested and maintained in the field. These decals provide the employee immediate indication of last maintenance date and if the tested device or system was found acceptable on the date of test. This local information can assist the employee in the assessment of overall electrical equipment maintenance status.”

The 2015 edition will be the tenth time NFPA 70E has been published since it was introduced in 1979. Each new edition continues to improve electrical safety in the workplace.

Source URL: <http://www.ecmag.com/section/codes-standards/change-way-2015-nfpa-70e>

**Citations cannot be issued for 70E consensus standards
but can be used to support OSHA citations**

OSHA Section 1910.333(a)(1) state that every employer shall furnish a place of employment free of any recognized hazards that might cause death or serious physical harm to the employee.

If the hazard cannot be removed the employer must provide the proper PPE.

Live parts to which an employee may be exposed must be de-energized before the employee works on or near them.

Unless the employer can demonstrate that de-energizing introduces additional or increased hazards or is not feasible due to equipment design or operational limitations.

Live parts that operate at less than 50 volts to ground need not be de-energized if there will be no increased exposure to electrical burns or to explosion due to electric arcs

Note:

70E is a consensus standard, which means citations cannot be issued for it. However OSHA is able to use it to support a citation. NFPA 70E has been used for citations under the following OSHA regulations;

General Duty clause 5(a)(1) of the OSHA Act, an employer “shall furnish to each of his employees employment and a place of employment which are free from recognized hazards that are causing or are likely to cause death or serious physical harm to his employees.”

OSHA Section 1910.335(a)(1)(i) states, “Employees working in areas where there are potential electrical hazards shall be provided with, and shall use, electrical protective equipment that is appropriate for the specific parts of the body to be protected and for the work to be performed.”

OSHA 1910.334(b)(2) Reclosing a circuit breaker or replace a fuse

It is a violation to reclose a circuit breaker or replace a fuse without first finding and fixing the short or determining that it was an overload that caused the circuit breaker to trip.

The repetitive manual reclosing of circuit breakers or reenergizing circuits through replace fuses is prohibited.

Note: When it can be determined from the design of the circuit and the overcurrent devices involved that the automatic operation of a device was caused by an overload rather than a fault condition, no examination of the circuit or connected equipment is needed before the circuit is reenergized.

- 1) Determine all possible sources of electrical supply to the specific equipment. Check applicable up-to-date drawings, diagrams, and identification tags.**
- 2) After properly interrupting the load current, open the disconnecting device(s) for each source.**
- 3) Wherever possible, visually verify that all blades, of the disconnecting devices are fully open or that drawout-type circuit breakers are withdrawn to the fully disconnected position.**
- 4) Apply lockout/tagout devices in accordance with a documented and established policy.**
- 5) Use an adequately rated test instrument to test each phase conductor or circuit part to verify it is deenergized. Test each phase conductor or circuit part both phase-to-phase and phase-to-ground. Before and after each test, determine that the test instrument is operating satisfactorily through verification on a known voltage source**
- 6) Where the possibility of induced voltages or stored electrical energy exists, ground the phase conductors or circuit parts before touching them. Where it could be reasonably anticipated that the conductors or circuit parts being de-energized could contact other exposed energized conductors or circuit parts, apply ground connecting devices rated for the available fault duty.**

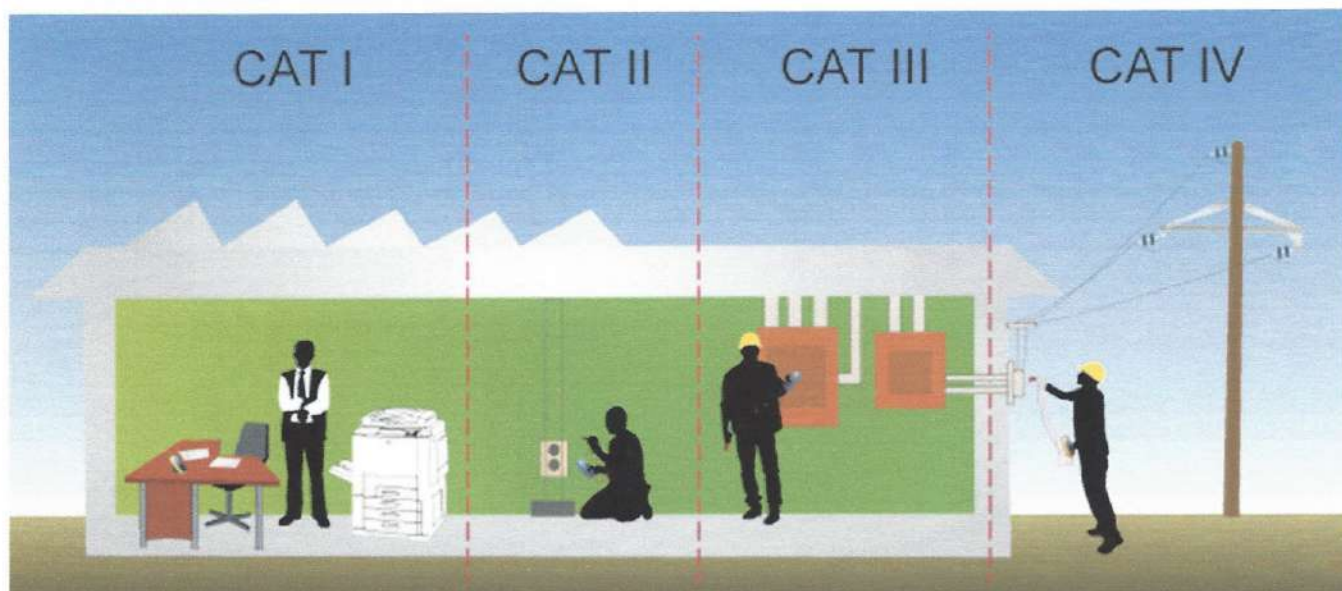

Measurement safety categories

The International Electrotechnical Commission (IEC) Standard 61010 describes performance specifications for low voltage (< 1000 V) test equipment. The higher the category, the higher the power available in that environment and the higher the test tool's ability to withstand transient energy.

Measurement category	In brief	Examples
CAT IV	Three-phase at utility connection, any outdoor conductors	<ul style="list-style-type: none"> Refers to the "origin of installation", i.e., where low-voltage connection is made to utility power. Electricity meters, primary overcurrent protection equipment. Outside and service entrance, service drop from pole to building, run between meter and panel. Overhead line to detached building, underground line to well pump.
CAT III	Three-phase distribution, including single-phase commercial lighting	<ul style="list-style-type: none"> Equipment in fixed installations, such as switchgear and polyphase motors. Bus and feeder in industrial plants. Feeders and short branch circuits, distribution panel devices. Lighting systems in larger buildings. Appliance outlets with short connections to service entrance.
CAT II	Single-phase receptacle connected loads	<ul style="list-style-type: none"> Appliance, portable tools, and other household and similar loads. Outlet and long branch circuits. <ul style="list-style-type: none"> Outlets at more than 10 meters (30 feet) from CAT III source. Outlets at more that 20 meters (60 feet) from CAT IV source.
CAT I	Electronic	<ul style="list-style-type: none"> Protected electronic equipment. Equipment connected to (source) circuits in which measures are taken to limit transient overvoltages to an appropriately low level. Any high-voltage, low-energy source derived from a high-winding resistance transformer, such as the high-voltage section of a copier.

Measurement categories. IEC 61010 applies to low-voltage (< 1000 V) test equipment.

Informative Annex G Sample Lockout/Tagout Procedure

This informative annex is not a part of the requirements of this NFPA document but is included for informational purposes only.

Lockout is the preferred method of controlling personnel exposure to electrical energy hazards. Tagout is an alternative method that is available to employers. To assist employers in developing a procedure that meets the requirement of 120.2 of *NFPA 70E*, the sample procedure that follows is provided for use in lockout and tagout programs. This procedure can be used for a simple lockout/tagout, or as part of a complex lockout/tagout. A more comprehensive plan will need to be developed, documented, and used for the complex lockout/tagout.

LOCKOUT/TAGOUT PROCEDURE FOR [COMPANY NAME]

OR

TAGOUT PROCEDURE FOR [COMPANY NAME]

1.0 Purpose. This procedure establishes the minimum requirements for lockout/tagout of electrical energy sources. It is to be used to ensure that conductors and circuit parts are disconnected from sources of electrical energy, locked (tagged), and tested before work begins where employees could be exposed to dangerous conditions. Sources of stored energy, such as capacitors or springs, shall be relieved of their energy, and a mechanism shall be engaged to prevent the reaccumulation of energy.

2.0 Responsibility. All employees shall be instructed in the safety significance of the lockout/tagout procedure. All new or transferred employees and all other persons whose work operations are or might be in the area shall be instructed in the purpose and use of this procedure. *[Name(s) of the person(s) or the job title(s) of the employee(s) with responsibility]* shall ensure that appropriate personnel receive instructions on their roles and responsibilities. All persons installing a lockout/tagout device shall sign their names and the date on the tag *[or state how the name of the individual or person in charge will be available]*.

3.0 Preparation for Lockout/Tagout.

3.1 Review current diagrammatic drawings (or their equivalent), tags, labels, and signs to identify and locate all disconnecting means to determine that power is interrupted by a physical break and not de-energized by a circuit interlock. Make a list of disconnecting means to be locked (tagged).

3.2 Review disconnecting means to determine adequacy of their interrupting ability. Determine if it will be possible to

verify a visible open point, or if other precautions will be necessary.

3.3 Review other work activity to identify where and how other personnel might be exposed to electrical hazards. Review other energy sources in the physical area to determine employee exposure to those sources of other types of energy. Establish energy control methods for control of other hazardous energy sources in the area.

3.4 Provide an adequately rated test instrument to test each phase conductor or circuit part to verify that they are de-energized (*see Section 11.3*). Provide a method to determine that the test instrument is operating satisfactorily.

3.5 Where the possibility of induced voltages or stored electrical energy exists, call for grounding the phase conductors or circuit parts before touching them. Where it could be reasonably anticipated that contact with other exposed energized conductors or circuit parts is possible, call for applying ground connecting devices.

4.0 Simple Lockout/Tagout. The simple lockout/tagout procedure will involve 1.0 through 3.0, 5.0 through 9.0, and 11.0 through 13.0.

5.0 Sequence of Lockout/Tagout System Procedures.

5.1 The employees shall be notified that a lockout/tagout system is going to be implemented and the reason for it. The qualified employee implementing the lockout/tagout shall know the disconnecting means location for all sources of electrical energy and the location of all sources of stored energy. The qualified person shall be knowledgeable of hazards associated with electrical energy.

5.2 If the electrical supply is energized, the qualified person shall de-energize and disconnect the electric supply and relieve all stored energy.

5.3 Wherever possible, the blades of disconnecting devices should be visually verified to be fully opened, or draw-out type circuit breakers should be verified to be completely withdrawn to the fully disconnected position.

5.4 Lockout/tagout all disconnecting means with lockout/tagout devices.

Informational Note: For tagout, one additional safety measure must be employed, such as opening, blocking, or removing an additional circuit element.



5.5 Attempt to operate the disconnecting means to determine that operation is prohibited.

5.6 A test instrument shall be used. (See 11.3.) Inspect the instrument for visible damage. Do not proceed if there is an indication of damage to the instrument until an undamaged device is available.

5.7 Verify proper instrument operation and then test for absence of voltage.

5.8 Verify proper instrument operation after testing for absence of voltage.

5.9 Where required, install a grounding equipment/conductor device on the phase conductors or circuit parts, to eliminate induced voltage or stored energy, before touching them. Where it has been determined that contact with other exposed energized conductors or circuit parts is possible, apply ground connecting devices rated for the available fault duty.

5.10 The equipment, electrical source, or both are now locked out (tagged out).

6.0 Restoring the Equipment, Electrical Supply, or Both to Normal Condition.

6.1 After the job or task is complete, visually verify that the job or task is complete.

6.2 Remove all tools, equipment, and unused materials and perform appropriate housekeeping.

6.3 Remove all grounding equipment/conductors/devices.

6.4 Notify all personnel involved with the job or task that the lockout/tagout is complete, that the electrical supply is being restored, and that they are to remain clear of the equipment and electrical supply.

6.5 Perform any quality control tests or checks on the repaired or replaced equipment, electrical supply, or both.

6.6 Remove lockout/tagout devices. The person who installed the devices is to remove them.

6.7 Notify the owner of the equipment, electrical supply, or both, that the equipment, electrical supply, or both are ready to be returned to normal operation.

6.8 Return the disconnecting means to their normal condition.

7.0 Procedure Involving More Than One Person. For a simple lockout/tagout and where more than one person is

involved in the job or task, each person shall install his or her own personal lockout/tagout device.

8.0 Procedure Involving More Than One Shift. When the lockout/tagout extends for more than one day, it shall be verified that the lockout/tagout is still in place at the beginning of the next day. When the lockout/tagout is continued on successive shifts, the lockout/tagout is considered to be a complex lockout/tagout.

For a complex lockout/tagout, the person in charge shall identify the method for transfer of the lockout/tagout and of communication with all employees.

9.0 Complex Lockout/Tagout. A complex lockout/tagout plan is required where one or more of the following exist:

- (1) Multiple energy sources (more than one)
- (2) Multiple crews
- (3) Multiple crafts
- (4) Multiple locations
- (5) Multiple employers
- (6) Unique disconnecting means
- (7) Complex or particular switching sequences
- (8) Lockout/tagout for more than one shift; that is, new shift workers

9.1 All complex lockout/tagout procedures shall require a written plan of execution. The plan shall include the requirements in 1.0 through 3.0, 5.0, 6.0, and 8.0 through 12.0.

9.2 A person in charge shall be involved with a complex lockout/tagout procedure. The person in charge shall be at the procedure location.

9.3 The person in charge shall develop a written plan of execution and communicate that plan to all persons engaged in the job or task. The person in charge shall be held accountable for safe execution of the complex lockout/tagout plan. The complex lockout/tagout plan must address all the concerns of employees who might be exposed, and they must understand how electrical energy is controlled. The person in charge shall ensure that each person understands the electrical hazards to which they are exposed and the safety-related work practices they are to use.

9.4 All complex lockout/tagout plans identify the method to account for all persons who might be exposed to electrical hazards in the course of the lockout/tagout.

One of the following methods is to be used:

- (1) Each individual shall install his or her own personal lockout or tagout device.



- (2) The person in charge shall lock his/her key in a lock box.
- (3) The person in charge shall maintain a sign-in/sign-out log for all personnel entering the area.
- (4) Another equally effective methodology shall be used.

9.5 The person in charge can install locks/tags or direct their installation on behalf of other employees.

9.6 The person in charge can remove locks/tags or direct their removal on behalf of other employees, only after all personnel are accounted for and ensured to be clear of potential electrical hazards.

9.7 Where the complex lockout/tagout is continued on successive shifts, the person in charge shall identify the method for transfer of the lockout and the method of communication with all employees.

10.0 Discipline.

10.1 Knowingly violating this procedure will result in *[state disciplinary actions that will be taken]*.

10.2 Knowingly operating a disconnecting means with an installed lockout device (tagout device) will result in *[state disciplinary actions to be taken]*.

11.0 Equipment.

11.1 Locks shall be *[state type and model of selected locks]*.

11.2 Tags shall be *[state type and model to be used]*.

11.3 The test instrument(s) to be used shall be *[state type and model]*.

12.0 Review. This procedure was last reviewed on *[date]* and is scheduled to be reviewed again on *[date]* (not more than 1 year from the last review).

13.0 Lockout/Tagout Training. Recommended training can include, but is not limited to, the following:

- (1) Recognition of lockout/tagout devices
- (2) Installation of lockout/tagout devices
- (3) Duty of employer in writing procedures
- (4) Duty of employee in executing procedures
- (5) Duty of person in charge
- (6) Authorized and unauthorized removal of locks/tags
- (7) Enforcement of execution of lockout/tagout procedures
- (8) Simple lockout/tagout
- (9) Complex lockout/tagout
- (10) Use of single-line and diagrammatic drawings to identify sources of energy
- (11) Alerting techniques
- (12) Release of stored energy
- (13) Personnel accounting methods
- (14) Temporary protective grounding equipment needs and requirements
- (15) Safe use of test instruments



Informative Annex I Job Briefing and Planning Checklist

This informative annex is not a part of the requirements of this NFPA document but is included for informational purposes only.

I.1 Job Briefing and Planning Checklist. Figure I.1 illustrates considerations for a job briefing and planning checklist.

Identify	
<input type="checkbox"/> Hazards	<input type="checkbox"/> Shock protection boundaries
<input type="checkbox"/> Voltage levels involved	<input type="checkbox"/> Available incident energy
<input type="checkbox"/> Skills required	<input type="checkbox"/> Potential for arc flash (Conduct an arc flash hazard analysis.)
<input type="checkbox"/> Any "foreign" (secondary source) voltage source	<input type="checkbox"/> Arc flash boundary
<input type="checkbox"/> Any unusual work conditions	
<input type="checkbox"/> Number of people needed to do the job	
Ask	
<input type="checkbox"/> Can the equipment be de-energized?	<input type="checkbox"/> Is a standby person required?
<input type="checkbox"/> Are backfeeds of the circuits to be worked on possible?	
Check	
<input type="checkbox"/> Job plans	<input type="checkbox"/> Safety procedures
<input type="checkbox"/> Single-line diagrams and vendor prints	<input type="checkbox"/> Vendor information
<input type="checkbox"/> Status board	<input type="checkbox"/> Individuals are familiar with the facility
<input type="checkbox"/> Information on plant and vendor resources is up to date	
Know	
<input type="checkbox"/> What the job is	<input type="checkbox"/> Who is in charge
<input type="checkbox"/> Who else needs to know — Communicate!	
Think	
<input type="checkbox"/> About the unexpected event . . . What if?	<input type="checkbox"/> Install and remove temporary protective grounding equipment
<input type="checkbox"/> Lock — Tag — Test — Try	<input type="checkbox"/> Install barriers and barricades
<input type="checkbox"/> Test for voltage — FIRST	<input type="checkbox"/> What else . . . ?
<input type="checkbox"/> Use the right tools and equipment, including PPE	
Prepare for an emergency	
<input type="checkbox"/> Is the standby person CPR trained?	<input type="checkbox"/> What is the exact work location?
<input type="checkbox"/> Is the required emergency equipment available? Where is it?	<input type="checkbox"/> How is the equipment shut off in an emergency?
<input type="checkbox"/> Where is the nearest telephone?	<input type="checkbox"/> Are the emergency telephone numbers known?
<input type="checkbox"/> Where is the fire alarm?	<input type="checkbox"/> Where is the fire extinguisher?
<input type="checkbox"/> Is confined space rescue available?	<input type="checkbox"/> Are radio communications available?

Figure I.1 Sample Job Briefing and Planning Checklist.

Informative Annex J Energized Electrical Work Permit

This informative annex is not a part of the requirements of this NFPA document but is included for informational purposes only.

J.1 Energized Electrical Work Permit Sample. Figure J.1 illustrates considerations for an energized electrical work permit.

J.2 Energized Electrical Work Permit. Figure J.2 illustrates items to consider when determining the need for an energized electrical work permit.

ENERGIZED ELECTRICAL WORK PERMIT

PART I: TO BE COMPLETED BY THE REQUESTER:

Job/Work Order Number _____

- (1) Description of circuit/equipment/job location: _____

- (2) Description of work to be done: _____

- (3) Justification of why the circuit/equipment cannot be de-energized or the work deferred until the next scheduled outage:

Requester/Title _____

Date _____

PART II: TO BE COMPLETED BY THE ELECTRICALLY QUALIFIED PERSONS DOING THE WORK:

**Check when
complete**

- (1) Detailed job description procedure to be used in performing the above detailed work: _____

- (2) Description of the safe work practices to be employed: _____

- (3) Results of the shock risk assessment: _____
 - (a) Voltage to which personnel will be exposed
 - (b) Limited approach boundary
 - (c) Restricted approach boundary
 - (d) Necessary shock, personal, and other protective equipment to safely perform assigned task
- (4) Results of the arc flash risk assessment: _____
 - (a) Available incident energy at the working distance or arc flash PPE category
 - (b) Necessary arc flash personal and other protective equipment to safely perform the assigned task
 - (c) Arc flash boundary
- (5) Means employed to restrict the access of unqualified persons from the work area: _____
- (6) Evidence of completion of a job briefing, including discussion of any job-related hazards: _____
- (7) Do you agree the above-described work can be done safely? Yes No (If no, return to requester.)

Electrically Qualified Person(s) _____

Date _____

Electrically Qualified Person(s) _____

Date _____

PART III: APPROVAL(S) TO PERFORM THE WORK WHILE ELECTRICALLY ENERGIZED:

Manufacturing Manager _____

Maintenance/Engineering Manager _____

Safety Manager _____

Electrically Knowledgeable Person _____

General Manager _____

Date _____

Note: Once the work is complete, forward this form to the site Safety Department for review and retention.

Figure J.1 Sample Permit for Energized Electrical Work.

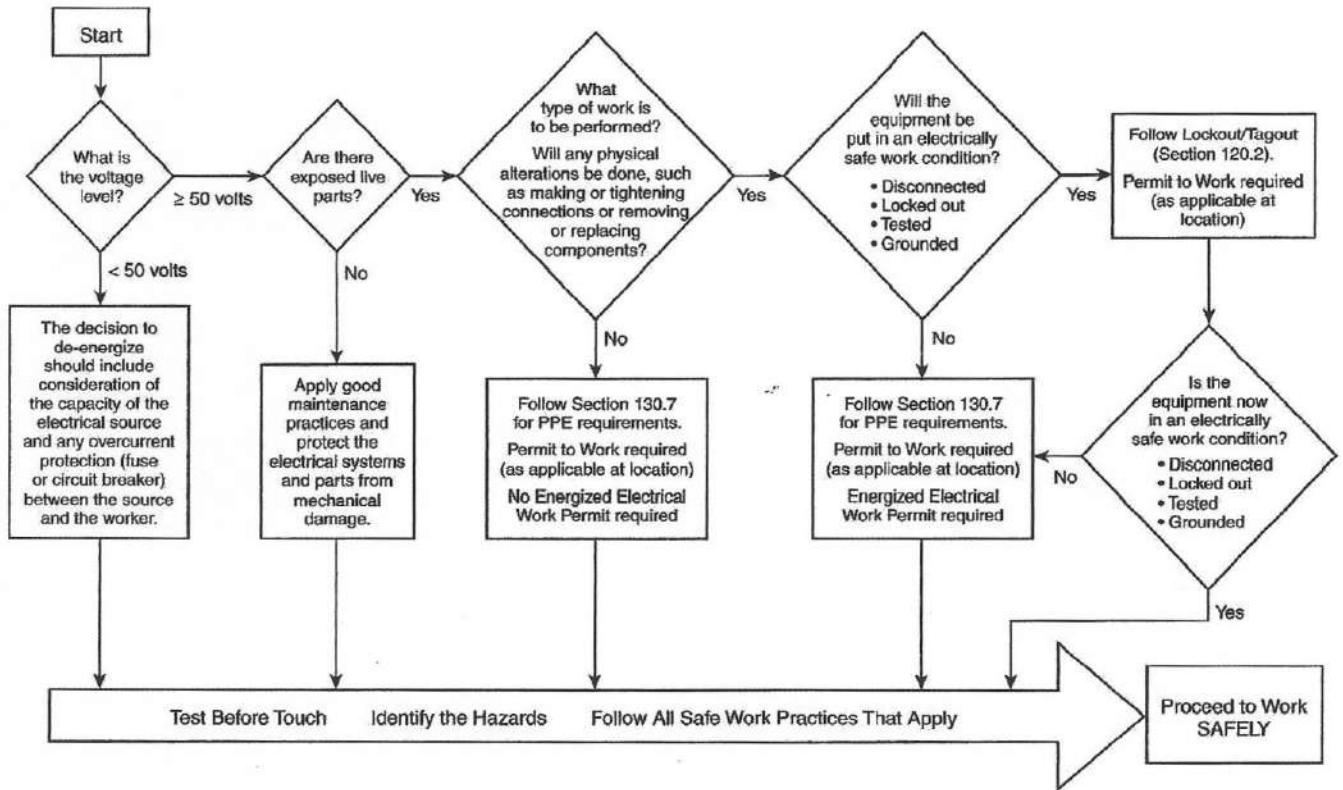
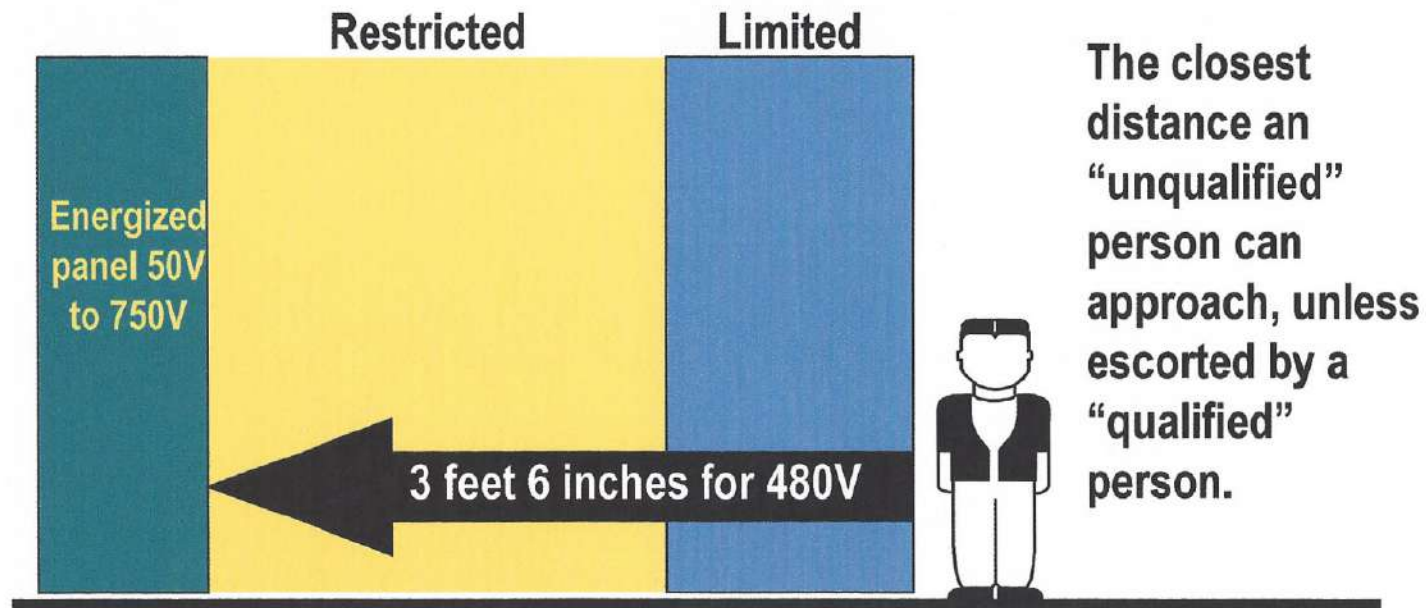

Figure J.2 Energized Electrical Work Permit Flow Chart.

Table 130.4(D)(a) and Section 130.4(C)
Limited Approach Boundary











Page 20

**For Shock Hazard Only- rubber gloves are needed in
the Restricted Approach boundary not the LAB**



- 1) Rubber insulating gloves will be used the restrictive approach boundary for shock hazards
- 2) Rubber insulating gloves shall be rated for the voltage for which the gloves will be exposed.
- 3) The leather protector of the glove is rated for 10 calories
- 4) Most of our work is dealing with AC 480V systems or less
- 5) Which means we would use a Class 00 rated glove most of the time [Max voltage is 500volts AC and 750volt DC]
- 6) Use gloves that are rated for the voltage of the system being worked on
- 7) These gloves must be replaced or electrically tested every 6 months from the date that is stamped on them
- 8) There is to be a visual inspection as well as an air test before daily use
- 9) Do no use hand lotion when the wearing gloves

Note: Always use the leather protectors over the rubber gloves for protection of the rubber

Class Color	Proof Test Voltage AC / DC	Max. Use Voltage AC / DC	Rubber Molded Products Label	Insulating Rubber Glove Label
00 Beige	2,500 / 10,000	500 / 750		
0 Red	5,000 / 20,000	1,000 / 1,500		
1 White	10,000 / 40,000	7,500 / 11,250		
2 Yellow	20,000 / 50,000	17,000 / 25,500		
3 Green	30,000 / 60,000	26,500 / 39,750		
4 Orange	40,000 / 70,000	36,000 / 54,000		

Approach Boundaries Table 130.4(D)(a)

to Energized Electrical Conductors or Circuit Parts for Shock Protection

Approach Boundaries for Alternating-Current Systems NFPA 70E Table 130.4(D)(a)

Nominal System Voltage Range, Phase to Phase	Limited Approach Boundary		Restricted Approach Boundary
	Exposed Movable Conductor	Exposed Fixed Circuit Part	Includes Inadvertent Movement Adder
<50V	Not Specified	Not Specified	Not Specified
50 V-150 V ^d	3.0 m (10 ft 0 in.)	1.0 m (3 ft 6 in.)	Avoid Contact
151 V-750 V	3.0 m (10 ft 0 in.)	1.0 m (3 ft 6 in.)	0.3 m (1 ft 0 in.)
751 V-15 kV	3.0 m (10 ft 0 in.)	1.5 m (5 ft 0 in.)	0.7 m (2 ft 2 in.)
15.1 kV-36 kV	3.0 m (10 ft 0 in.)	1.8 m (6 ft 0 in.)	0.8 m (2 ft 7 in.)
36.1 kV-46 kV	3.0 m (10 ft 0 in.)	2.5 m (8 ft 0 in.)	0.8 m (2 ft 9 in.)
46.1 kV-72.5 kV	3.0 m (10 ft 0 in.)	2.5 m (8 ft 0 in.)	1.0 m (3 ft 3 in.)
72.6 kV-121 kV	3.3 m (10 ft 8 in.)	2.5 m (8 ft 0 in.)	1.0 m (3 ft 4 in.)
138 kV-145 kV	3.4 m (11 ft 0 in.)	3.0 m (10 ft 0 in.)	1.2 m (3 ft 10 in.)
161 kV-169 kV	3.6 m (11 ft 8 in.)	3.6 m (11 ft 8 in.)	1.3 m (4 ft 3 in.)
230 kV-242 kV	4.0 m (13 ft 0 in.)	4.0 m (13 ft 0 in.)	1.7 m (5 ft 8 in.)
345 kV-362 kV	4.7 m (15 ft 4 in.)	4.7 m (15 ft 4 in.)	2.8 m (9 ft 2 in.)
500 kV-550 kV	5.8 m (19 ft 0 in.)	5.8 m (19 ft 0 in.)	3.6 m (11 ft 10 in.)
765 kV-800 kV	7.2 m (23 ft 9 in.)	7.2 m (23 ft 9 in.)	4.9 m (15 ft 11 in.)

NFPA 70E 2015 130.4 Approach Boundaries to Energized Electrical Conductors or Circuit Parts for Shock Protection.

(A) **Shock Risk Assessment.** A shock risk assessment shall determine the voltage to which personnel will be exposed, the boundary requirement, and the PPE necessary in order to minimize the possibility of electric shock to personnel.

(B) **Shock Protection Boundaries.** The shock protection boundaries identified as limited approach boundary and restricted approach boundary shall be applicable where approaching personnel are exposed to energized electrical conductors or circuit parts. Table 130.4(D)(a) shall be used for the distances associated with various ac systems voltages. Table 130.4(D)(a) shall be used for the distances associated with various dc system voltages.

(C) Limited Approach Boundary.

- (1) **Approach by Unqualified Persons.** Unless permitted by 130.4(C)(3), no unqualified person shall be permitted to approach nearer than the limited approach boundary of energized conductors or circuit parts.
- (2) **Working at or Close to the Limited Approach Boundary.** Where one or more unqualified persons are working at or close to the limited approach boundary, the designated person in charge of the work space where the electrical hazard exists shall advise the unqualified person(s) of the electrical hazard and warn him or her to stay outside the limited approach boundary.

(3) **Entering the Limited Approach Boundary.** Where there is a need for an unqualified person(s) to cross the limited approach boundary, a qualified person shall advise him or her of the possible hazards and continuously escort the unqualified person(s) while inside the Limited Approach Boundary. Under no circumstance shall the escorted unqualified person(s) be permitted to cross the Restricted Approach Boundary.

(D) **Restricted Approach Boundary.** No qualified person shall approach or take any conductive object closer exposed energized electrical conductors or circuit parts operating at 50 volts or more than the restricted approach boundary set forth in Table 130.4(D)(a) and Table 130.4(D)(b), unless one of the following conditions applies:

- (1) The qualified person is insulated or guarded from the energized electrical conductors or circuit parts operating at 50 volts or more. Insulating gloves or insulating gloves and sleeves are considered insulation only with regard to the energized parts upon which work is being performed. If there is a need for an uninsulated part of the qualified persons body to contact exposed energized electrical conductors or circuit parts, a combination of 130.4(D)(1), 130.4(D)(2), and 130.4(D)(3), shall be used to protect the uninsulated body parts.
- (2) The energized electrical conductors or circuit part operating at 50 volts or more are insulated from the qualified person and from any other conductive object at a different potential.
- (3) The qualified person is insulated from any other conductive object.

Code of Federal Regulations 1910**C. Provisions for Inadvertent Movement**

The minimum approach distances (working distances) must include an “adder” to compensate for the inadvertent movement of the worker relative to an energized part or the movement of the part relative to the worker. A certain allowance must be made to account for this possible inadvertent movement and to provide the worker with a comfortable and safe zone in which to work. A distance for inadvertent movement (called the “ergonomic component of the minimum approach distance”) must be added to the electrical component to determine the total safe minimum approach distances used in live-line work.

One approach that can be used to estimate the ergonomic component for the minimum approach distance is response time-distance analysis. When this technique is used, the total response time to a hazardous incident is estimated and converted to distance travelled. For example, the driver of a car takes a given amount of time to respond to a “stimulus” and stop the vehicle. The elapsed time involved results in a distance being traveled before the car comes to a complete stop. This distance is dependent on the speed of the car at the time the stimulus appears.

In the case of live-line work, the employee must first perceive that he or she is approaching the danger zone. Then, the worker responds to the danger and must decelerate and stop all motion toward the energized part. During the time it takes to stop, a distance will have been traversed. It is this distance that must be added to the electrical component of the minimum approach distance to obtain the total safe minimum approach distance.

Approach Boundaries for Direct-Current Voltage Systems NFPA 70E Table 130.4(D)(b)

Nominal System Voltage Range, Phase to Phase	Limited Approach Boundary		Restricted Approach Boundary
	Exposed Movable Conductor	Exposed Fixed Circuit Part	Includes Inadvertant Movement Adder
<100V	Not Specified	Not Specified	Not Specified
100 V-300 V	3.0 m (10 ft 0 in.)	1.0 m (3 ft 6 in.)	Avoid Contact
301 V-1 kV	3.0 m (10 ft 0 in.)	1.0 m (3 ft 6 in.)	0.3 m (1 ft 0 in.)
1.1 kV-5 kV	3.0 m (10 ft 0 in.)	1.5 m (5 ft 0 in.)	0.5 m (1 ft 5 in.)
5 kV-15 kV	3.0 m (10 ft 0 in.)	1.5 m (5 ft 0 in.)	0.7 m (2 ft 2 in.)
15.1 kV-45 kV	3.0 m (10 ft 0 in.)	2.5 m (8 ft 0 in.)	0.8 m (2 ft 9 in.)
45.1 kV-75 kV	3.0 m (10 ft 0 in.)	2.5 m (8 ft 0 in.)	1.0 m (3 ft 2 in.)
75.1 kV-150 kV	3.3 m (10 ft 8 in.)	3.0 m (10 ft 0 in.)	1.2 m (4 ft 0 in.)
150.1 kV-250 kV	3.6 m (11 ft 8 in.)	3.6 m (11 ft 8 in.)	1.6 m (5 ft 3 in.)
250.1 kV-500 kV	6.0 m (12 ft 0 in.)	6.0 m (20 ft 0 in.)	3.5 m (11 ft 6 in.)
500.1 kV-800 kV	8.0 m (26 ft 0 in.)	8.0 m (26 ft 0 in.)	5.0 m (16 ft 5 in.)

NFPA 70E 2015 130.4 Approach Boundaries to Energized Electrical Conductors or Circuit Parts for Shock Protection.

(A) **Shock Risk Assessment.** A shock risk assessment shall determine the voltage to which personnel will be exposed, the boundary requirement, and the PPE necessary in order to minimize the possibility of electric shock to personnel.

(B) **Shock Protection Boundaries.** The shock protection boundaries identified as limited approach boundary and restricted approach boundary shall be applicable where approaching personnel are exposed to energized electrical conductors or circuit parts. Table 130.4(D)(a) shall be used for the distances associated with various ac systems voltages. Table 130.4(D)(a) shall be used for the distances associated with various dc system voltages.

(C) Limited Approach Boundary.

(1) **Approach by Unqualified Persons.** Unless permitted by 130.4(C)(3), no unqualified person shall be permitted to approach nearer than the limited approach boundary of energized conductors or circuit parts.

(2) **Working at or Close to the Limited Approach Boundary.** Where one or more unqualified persons are working at or close to the limited approach boundary, the designated person in charge of the work space where the electrical hazard exists shall advise the unqualified person(s) of the electrical hazard and warn him or her to stay outside the limited approach boundary.

(3) **Entering the Limited Approach Boundary.** Where there is a need for an unqualified person(s) to cross the limited approach boundary, a qualified person shall advise him or her of the possible hazards and continuously escort the unqualified person(s) while inside the Limited Approach Boundary. Under no circumstance shall the escorted unqualified person(s) be permitted to cross the Restricted Approach Boundary.

(D) **Restricted Approach Boundary.** No qualified person shall approach or take any conductive object closer exposed energized electrical conductors or circuit parts operating at 50 volts or more than the restricted approach boundary set forth in Table 130.4(D)(a) and Table 130.4(D)(b), unless one of the following conditions applies:

(1) The qualified person is insulated or guarded from the energized electrical conductors or circuit parts operating at 50 volts or more. Insulating gloves or insulating gloves and sleeves are considered insulation only with regard to the energized parts upon which work is being performed. If there is a need for an unqualified part of the qualified persons body to contact exposed energized electrical conductors or circuit parts, a combination of

130.4(D)(1), 130.4(D)(2), and 130.4(D)(3), shall be used to protect the uninsulated body parts.

(2) The energized electrical conductors or circuit part operating at 50 volts or more are insulated from the qualified person and from any other conductive object at a different potential.

(3) The qualified person is insulated from any other conductive object.

Table 130.7(C)(15)(A)(a) Arc Flash Hazard Identification for Alternating Current (ac) and Direct Current (dc) Systems

Task	Equipment Condition*	Arc Flash PPE Required
Reading a panel meter while operating a meter switch	Any	No
Normal operation of a circuit breaker (CB), switch, contactor, or starter	All of the following: The equipment is properly installed The equipment is properly maintained All equipment doors are closed and secured All equipment covers are in place and secured There is no evidence of impending failure	No
	One or more of the following: The equipment is not properly installed The equipment is not properly maintained Equipment doors are open or not secured Equipment covers are off or not secured There is evidence of impending failure	Yes
For ac systems: Work on energized electrical conductors and circuit parts, including voltage testing	Any	Yes
For dc systems: Work on energized electrical conductors and circuit parts of series-connected battery cells, including voltage testing	Any	Yes
Voltage testing on individual battery cells or individual multi-cell units	All of the following: The equipment is properly installed The equipment is properly maintained Covers for all other equipment are in place and secured There is no evidence of impending failure	No
	One or more of the following: The equipment is not properly installed The equipment is not properly maintained Equipment doors are open or not secured Equipment covers are off or not secured There is evidence of impending failure	Yes
Removal or installation of CBs or switches	Any	Yes
Removal or installation of covers for equipment such as wireways, junction boxes, and cable trays that does not expose bare energized electrical conductors and circuit parts	All of the following: The equipment is properly installed The equipment is properly maintained There is no evidence of impending failure	No
	Any of the following: The equipment is not properly installed The equipment is not properly maintained There is evidence of impending failure	Yes
Removal of bolted covers (to expose bare energized electrical conductors and circuit parts). For dc systems, this includes bolted covers, such as battery terminal covers.	Any	Yes

(continues)

Table 130.7(C)(15)(A)(a) *Continued*

Task	Equipment Condition*	Arc Flash PPE Required
Removal of battery intercell connector covers	All of the following: The equipment is properly installed. The equipment is properly maintained Covers for all other equipment are in place and secured There is no evidence of impending failure	No
	One or more of the following: The equipment is not properly installed The equipment is not properly maintained Equipment doors are open or not secured Equipment covers are off or not secured There is evidence of impending failure	Yes
Opening hinged door(s) or cover(s) (to expose bare energized electrical conductors and circuit parts)	Any	Yes
Perform infrared thermography and other noncontact inspections outside the restricted approach boundary. This activity does not include opening of doors or covers.	Any	No
Application of temporary protective grounding equipment after voltage test	Any	Yes
Work on control circuits with exposed energized electrical conductors and circuit parts, 120 volts or below without any other exposed energized equipment over 120 V including opening of hinged covers to gain access	Any	No
Work on control circuits with exposed energized electrical conductors and circuit parts, greater than 120 V	Any	Yes
Insertion or removal of individual starter buckets from motor control center (MCC)	Any	Yes
Insertion or removal (racking) of CBs or starters from cubicles, doors open or closed	Any	Yes
Insertion or removal of plug-in devices into or from busways	Any	Yes
Insulated cable examination with no manipulation of cable	Any	No
Insulated cable examination with manipulation of cable	Any	Yes
Work on exposed energized electrical conductors and circuit parts of equipment directly supplied by a panelboard or motor control center	Any	Yes
Insertion and removal of revenue meters (kW-hour, at primary voltage and current)	Any	Yes
For dc systems, insertion or removal of individual cells or multi-cell units of a battery system in an enclosure	Any	Yes
For dc systems, insertion or removal of individual cells or multi-cell units of a battery system in an open rack	Any	No

Table 130.7(C)(15)(A)(a) *Continued*

Task	Equipment Condition*	Arc Flash PPE Required
For dc systems, maintenance on a single cell of a battery system or multi-cell units in an open rack	Any	No
For dc systems, work on exposed energized electrical conductors and circuit parts of utilization equipment directly supplied by a dc source	Any	Yes
Arc-resistant switchgear Type 1 or 2 (for clearing times of <0.5 sec with a prospective fault current not to exceed the arc-resistant rating of the equipment) and metal enclosed interrupter switchgear, fused or unfused of arc resistant type construction, tested in accordance with IEEE C37.20.7: •Insertion or removal (racking) of CBs from cubicles •Insertion or removal (racking) of ground and test device •Insertion or removal (racking) of voltage transformers on or off the bus	All of the following: The equipment is properly installed The equipment is properly maintained All equipment doors are closed and secured All equipment covers are in place and secured There is no evidence of impending failure	No
	One or more of the following: The equipment is not properly installed The equipment is not properly maintained Equipment doors are open or not secured Equipment covers are off or not secured There is evidence of impending failure	Yes
Opening voltage transformer or control power transformer compartments	Any	Yes
Outdoor disconnect switch operation (hookstick operated) at 1 kV through 15 kV	Any	Yes
Outdoor disconnect switch operation (gang-operated, from grade) at 1 kV through 15 kV	Any	Yes

Note: Hazard identification is one component of risk assessment. Risk assessment involves a determination of the likelihood of occurrence of an incident, resulting from a hazard that could cause injury or damage to health. The assessment of the likelihood of occurrence contained in this table does not cover every possible condition or situation. Where this table indicates that arc flash PPE is not required, an arc flash is not likely to occur.

*The phrase *properly installed*, as used in this table, means that the equipment is installed in accordance with applicable industry codes and standards and the manufacturer's recommendations. The phrase *properly maintained*, as used in this table, means that the equipment has been maintained in accordance with the manufacturer's recommendations and applicable industry codes and standards. The phrase *evidence of impending failure*, as used in this table, means that there is evidence of arcing, overheating, loose or bound equipment parts, visible damage, deterioration, or other damage.

Table 130.7(C)(15)(A)(b) Arc-Flash Hazard PPE Categories for Alternating Current (ac) Systems

Equipment	Arc Flash PPE Category	Arc-Flash Boundary
Panelboards or other equipment rated 240 V and below Parameters: Maximum of 25 kA short-circuit current available; maximum of 0.03 sec (2 cycles) fault clearing time; working distance 455 mm (18 in.)	1	485 mm (19 in.)
Panelboards or other equipment rated >240 V and up to 600 V Parameters: Maximum of 25 kA short-circuit current available; maximum of 0.03 sec (2 cycles) fault clearing time; working distance 455 mm (18 in.)	2	900 mm (3 ft)
600-V class motor control centers (MCCs) Parameters: Maximum of 65 kA short-circuit current available; maximum of 0.03 sec (2 cycles) fault clearing time; working distance 455 mm (18 in.)	2	1.5 m (5 ft)
600-V class motor control centers (MCCs) Parameters: Maximum of 42 kA short-circuit current available; maximum of 0.33 sec (20 cycles) fault clearing time; working distance 455 mm (18 in.)	4	4.3 m (14 ft)
600-V class switchgear (with power circuit breakers or fused switches) and 600 V class switchboards Parameters: Maximum of 35 kA short-circuit current available; maximum of up to 0.5 sec (30 cycles) fault clearing time; working distance 455 mm (18 in.)	4	6 m (20 ft)
Other 600-V class (277 V through 600 V, nominal) equipment Parameters: Maximum of 65 kA short circuit current available; maximum of 0.03 sec (2 cycles) fault clearing time; working distance 455 mm (18 in.)	2	1.5 m (5 ft)
NEMA E2 (fused contactor) motor starters, 2.3 kV through 7.2 kV Parameters: Maximum of 35 kA short-circuit current available; maximum of up to 0.24 sec (15 cycles) fault clearing time; working distance 910 mm (36 in.)	4	12 m (40 ft)
Metal-clad switchgear, 1 kV through 15 kV Parameters: Maximum of 35 kA short-circuit current available; maximum of up to 0.24 sec (15 cycles) fault clearing time; working distance 910 mm (36 in.)	4	12 m (40 ft)
Arc-resistant switchgear Type 1 or 2 [for clearing times of < 0.5 sec (30 cycles) with a perspective fault current not to exceed the arc-resistant rating of the equipment], and metal-enclosed interrupter switchgear, fused or unfused of arc-resistant-type construction, tested in accordance with IEEE C37.20.7, 1 kV through 15 kV Parameters: Maximum of 35 kA short-circuit current available; maximum of up to 0.24 sec (15 cycles) fault clearing time; working distance 910 mm (36 in.)	N/A (doors closed) 4 (doors open)	N/A (doors closed) 12 m (40 ft)
Other equipment 1 kV through 15 kV Parameters: Maximum of 35 kA short-circuit current available; maximum of up to 0.24 sec (15 cycles) fault clearing time; working distance 910 mm (36 in.)	4	12 m (40 ft)

Note: For equipment rated 600 volts and below, and protected by upstream current-limiting fuses or current-limiting circuit breakers sized at 200 amperes or less, the arc flash PPE category can be reduced by one number but not below arc flash PPE category 1.

Table 130.7(C)(15)(A)(b) for DC circuits

Table 130.7(C)(15)(B) Arc-Flash Hazard PPE Categories for Direct Current (dc) Systems

Equipment	Arc Flash PPE Category	Arc-Flash Boundary
Storage batteries, dc switchboards, and other dc supply sources 100 V > Voltage < 250 V Parameters: Voltage: 250 V Maximum arc duration and working distance: 2 sec @ 455 mm (18 in.)		
Short-circuit current < 4 kA	1	900 mm (3 ft)
4 kA ≤ short-circuit current < 7 kA	2	1.2 m (4 ft)
7 kA ≤ short-circuit current < 15 kA	3	1.8 m (6 ft)
Storage batteries, dc switchboards, and other dc supply sources 250 V ≤ Voltage ≤ 600 V Parameters: Voltage: 600 V Maximum arc duration and working distance: 2 sec @ 455 mm (18 in.)		
Short-circuit current 1.5 kA	1	900 mm (3 ft)
1.5 kA ≤ short-circuit current < 3 kA	2	1.2 m (4 ft)
3 kA ≤ short-circuit current < 7 kA	3	1.8 m (6 ft.)
7 kA ≤ short-circuit current < 10 kA	4	2.5 m (8 ft)

Note: Apparel that can be expected to be exposed to electrolyte must meet both of the following conditions:

- (1) Be evaluated for electrolyte protection in accordance with ASTM F1296, *Standard Guide for Evaluating Chemical Protective Clothing*
- (2) Be arc-rated in accordance with ASTM F1891, *Standard Specification for Arc Rated and Flame Resistant Rainwear*, or equivalent

(16) Protective Clothing and Personal Protective Equipment (PPE). Once the arc flash PPE category has been identified from Table 130.7(C)(15)(A)(b) or Table 130.7(C)(15)(B), Table 130.7(C)(16) shall be used to determine the required PPE for the task. Table 130.7(C)(16) lists the requirements for PPE based on arc flash PPE categories 1 through 4. This clothing and equipment shall be used when working within the arc flash boundary.

Informational Note No. 1: See Informative Annex H for a suggested simplified approach to ensure adequate PPE for

electrical workers within facilities with large and diverse electrical systems.

Informational Note No. 2: The PPE requirements of this section are intended to protect a person from arc flash hazards. While some situations could result in burns to the skin, even with the protection described in Table 130.7(C)(16), burn injury should be reduced and survivable. Due to the explosive effect of some arc events, physical trauma injuries could occur. The PPE requirements of this section do not address protection against physical trauma other than exposure to the thermal effects of an arc flash.

Informational Note No. 3: The arc rating for a particular clothing system can be obtained from the arc-rated clothing manufacturer.

Table 130.7(C)(16) Personal Protective Equipment (PPE)

PPE Category	PPE
1	<p>Arc-Rated Clothing, Minimum Arc Rating of 4 cal/cm² (see Note 1)</p> <p>Arc-rated long-sleeve shirt and pants or arc-rated coverall</p> <p>Arc-rated face shield (see Note 2) or arc flash suit hood</p> <p>Arc-rated jacket, parka, rainwear, or hard hat liner (AN)</p> <p>Protective Equipment</p> <p>Hard hat</p> <p>Safety glasses or safety goggles (SR)</p> <p>Hearing protection (ear canal inserts)</p> <p>Heavy duty leather gloves (see Note 3)</p> <p>Leather footwear (AN)</p>
2	<p>Arc-Rated Clothing, Minimum Arc Rating of 8 cal/cm² (see Note 1)</p> <p>Arc-rated long-sleeve shirt and pants or arc-rated coverall</p> <p>Arc-rated flash suit hood or arc-rated face shield (see Note 2) and arc-rated balaclava</p> <p>Arc-rated jacket, parka, rainwear, or hard hat liner (AN)</p> <p>Protective Equipment</p> <p>Hard hat</p> <p>Safety glasses or safety goggles (SR)</p> <p>Hearing protection (ear canal inserts)</p> <p>Heavy duty leather gloves (see Note 3)</p> <p>Leather footwear</p>
3	<p>Arc-Rated Clothing Selected so That the System Arc Rating Meets the Required Minimum Arc Rating of 25 cal/cm² (see Note 1)</p> <p>Arc-rated long-sleeve shirt (AR)</p> <p>Arc-rated pants (AR)</p> <p>Arc-rated coverall (AR)</p> <p>Arc-rated arc flash suit jacket (AR)</p> <p>Arc-rated arc flash suit pants (AR)</p> <p>Arc-rated arc flash suit hood</p> <p>Arc-rated gloves (see Note 1)</p> <p>Arc-rated jacket, parka, rainwear, or hard hat liner (AN)</p> <p>Protective Equipment</p> <p>Hard hat</p> <p>Safety glasses or safety goggles (SR)</p> <p>Hearing protection (ear canal inserts)</p> <p>Leather footwear</p>

Table 130.7(C)(16) Continued

PPE Category	PPE
4	<p>Arc-Rated Clothing Selected so That the System Arc Rating Meets the Required Minimum Arc Rating of 40 cal/cm² (see Note 1)</p> <p>Arc-rated long-sleeve shirt (AR)</p> <p>Arc-rated pants (AR)</p> <p>Arc-rated coverall (AR)</p> <p>Arc-rated arc flash suit jacket (AR)</p> <p>Arc-rated arc flash suit pants (AR)</p> <p>Arc-rated arc flash suit hood</p> <p>Arc-rated gloves (see Note 1)</p> <p>Arc-rated jacket, parka, rainwear, or hard hat liner (AN)</p> <p>Protective Equipment</p> <p>Hard hat</p> <p>Safety glasses or safety goggles (SR)</p> <p>Hearing protection (ear canal inserts)</p> <p>Leather footwear</p>

AN: as needed (optional). AR: as required. SR: selection required.

Notes:

(1) Arc rating is defined in Article 100.

(2) Face shields are to have wrap-around guarding to protect not only the face but also the forehead, ears, and neck, or, alternatively, an arc-rated arc flash suit hood is required to be worn.

(3) If rubber insulating gloves with leather protectors are used, additional leather or arc-rated gloves are not required. The combination of rubber insulating gloves with leather protectors satisfies the arc flash protection requirement.

(D) Other Protective Equipment.

(1) Insulated Tools and Equipment. Employees shall use insulated tools or handling equipment, or both, when working inside the restricted approach boundary of exposed energized electrical conductors or circuit parts where tools or handling equipment might make accidental contact. Insulated tools shall be protected from damage to the insulating material.

Informational Note: See 130.4(B), Shock Protection Boundaries.

(a) Requirements for Insulated Tools. The following requirements shall apply to insulated tools:

- (1) Insulated tools shall be rated for the voltages on which they are used.
- (2) Insulated tools shall be designed and constructed for the environment to which they are exposed and the manner in which they are used.
- (3) Insulated tools and equipment shall be inspected prior to each use. The inspection shall look for damage to the insulation or damage that can limit the tool from performing its intended function or could increase the potential for an incident (e.g., damaged tip on a screwdriver).



Diagram of an Electrical Arc Blast

[see Annex K Page 11 for a detailed description]

This is what can happen to you in less than 10 cycles of a second

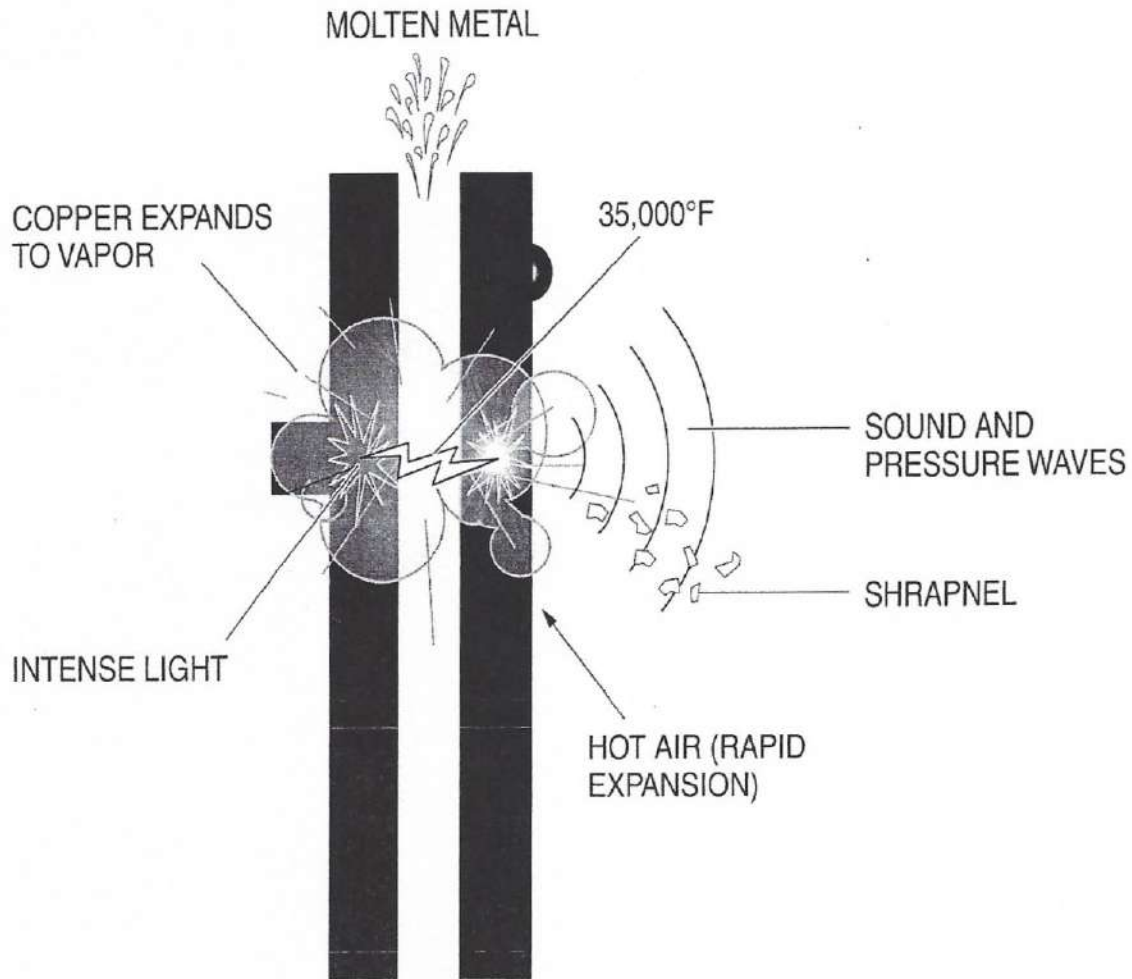

Remember: Arc flashes can and do kill at distances of 10 feet

OSHA Compliant Arc Flash Warning Label

All hazardous equipment installed or modified after 2002 is required to carry a 4"x 6" ANSI Z535 compliant electrical warning label. NEC 110.16 specifically mentions "switchboards, panel boards, industrial control panels and motor control centers that ... are likely to require examination, adjustment, servicing, or maintenance while energized."

Equipment must be marked in the field, rather than by the equipment manufacturer or installer. Arc flash hazard varies depending on actual operating conditions, including upcurrent protective devices and voltage. Labeling is the responsibility of the company operating the equipment.

NEC (National Electrical Code) has made three required changes to the Arc Flash Warning Label. These changes became law on November 1st, 2011. The new additions are highlighted in yellow below.

The diagram shows a rectangular warning label with a red top section containing a white exclamation mark and the word "WARNING" in large black letters. Below this is a white section with the text "Arc Flash & Shock Hazard Appropriate PPE Required". The main body of the label is divided into two columns. The left column is titled "FLASH PROTECTION" and contains the following information: "Flash Hazard Category: 4", "Min. Arc Rating (cal/cm2): 37.9", and a list of PPE items with checkboxes: Cotton Underwear, Short Sleeved T-Shirt (Natural Fiber), Arc Rated Long Sleeved Shirt, Long Pants & Coveralls, Arc Rated (40 cal) Arc Flash Suit Jacket, Pants & Hood, Hard Hat & Hearing Protection, Safety Glasses or Goggles, Arc Rated Leather Gloves or Insulating Gloves w/Protectors, and Leather Shoes. The right column is titled "SHOCK PROTECTION" and contains: "480 VAC Shock Hazard When: WHEN COVER IS OPENED OR REMOVED", "Flash Protection Boundary: 100'", "Limited Approach Boundary: 42'", "Restricted Approach Boundary: 12'", "Prohibited Approach Boundary: 1'", "Max. Available Fault Current: 38300 A", and "PPE: [X] CAT 100' Gloves". At the bottom of the label, there is an "Equipment ID: Secondary XF 24 (source)", a date "10/25/20", a website "gdlu.com", and a logo. Callouts A through K point to various elements: A (Warning sign), B (Flash Hazard Category), C (Min. Arc Rating), D (PPE list), E (Equipment ID), F (Warning sign), G (Flash Protection Boundary), H (Limited Approach Boundary), I (Restricted Approach Boundary), J (Prohibited Approach Boundary), and K (Date/Website/Logo).

A. These durable UV and chemical resistant 3.2 mil laminated vinyl labels include a High-Tack adhesive and rounded corners to prevent peeling. The life span of these labels is 5 years in normal conditions and are capable of withstanding temperatures beyond 165 °F and -50 °F. Sufficient label durability is now a requirement as of the November 2011 NEC (National Electrical Code) update and ITU's arc flash warning labels more than exceed this requirement.

B. Flash Hazard Category: Represents the level of danger depending on the incident energy. Ratings range in number from 0-4. 0 represents little or no risk while 4 signifies greatest risk. For more information about the different arc flash hazard risk categories go to www.HazardRiskCategories.com

C. Minimum Arc Rating: Identifies the arc performance of a material or system of materials (PPE) and are expressed in calories per centimeter squared.

D. PPE: Identifies the Personal Protective Equipment that MUST be used according to the hazard category rating.

E. Equipment ID: Identifies panel name or association.

F. Arc flash warning labels must have the word "WARNING" in black with an orange background and include the standard warning symbol (orange exclamation point with solid black triangle background).

G. Flash Protection Boundary: This is the closest anyone can approach the equipment that has the potential for arc flash, without the use of PPE (Personal Protective Equipment).

H. Limited Approach Boundary: This boundary may only be crossed by a "qualified" person who has been trained in the hazards of the component or equipment being serviced.

I. Restricted Approach Boundary and Prohibited Approach Boundary: Only a qualified person using adequate shock prevention equipment and techniques may cross these boundaries.

J. Maximum Available Fault Current: This is one of the new NEC required features as of November 2011. All the required safety information provided on the label is based on the max. available fault current. If the system is altered in any way resulting in this value to change then the data must be re-evaluated. (NEC 2011 110.24)

Companies or utilities will often make changes in the electrical system to be more efficient or to increase capacity. When this is done the max. available fault current is likely to change. As a result the PPE (Personal Protection Equipment) category and the approach boundary information becomes inaccurate and is no longer compliant. Inaccurate information could easily result in serious injury or even death in which the company would be held liable.

K. The date that the fault current calculation was performed should be on the label. The arc flash hazard analysis shall be updated when a major modification or renovation takes place. It shall be reviewed periodically, not to exceed 5 years, to account for changes in the electrical distribution system that could affect the results of the arc flash hazard analysis. (NFPA 70E section 130.5)

NEC has made an exception to these three additions. Those that have had an arc flash analysis performed prior to September 2011 with arc flash warning labels that are less than five years old shall be exempt. However, the labels must be updated and include these additions when the existing arc flash warning labels expire. The exception does require documentation of "the method of calculating and data to support the information for the arc flash warning label."

OSHA requires many of the key components of ITU's arc flash analysis (arc flash hazard study). If an injury or death occurs due to electrical hazard the company managing the facility is at fault if they are not within OSHA compliance. An Arc Flash Analysis (also known as Incident Energy Analysis, Arc Flash Hazard Analysis, Power Distribution Study, Short Circuit Study, Short Circuit analysis, Arc Flash Hazard Assessment or Arc Flash Hazard Assessment Study) is a study of your facilities electrical system. This Arc Flash Study will determine the areas of potential danger of electrocution, electrical fatalities, or electrical arc blasts. ITU's arc flash study also includes detailed reports of your electrical system, one-line diagrams, and ANSI Z535 approved warning labels to warn workers of these danger areas and to inform them of the proper personal protection equipment (PPE) to use while working in these areas.

ITU offers a fast, practical, "No Frills", low cost Arc Flash Analysis and award winning NFPA 70E electrical safety training that is second to none in the industry. Call ITU today or go to www.ArcFlashEngineering.com to find out how easy and affordable it is to get in compliance.

Page 2



Toll-Free
800-381-4389

Visit us online at:
www.goITU.com

ITU.....The National Leader in Arc Flash Analysis, Training, and Electrical Safety!

Available Fault Current
Field Markings
110.24(A)

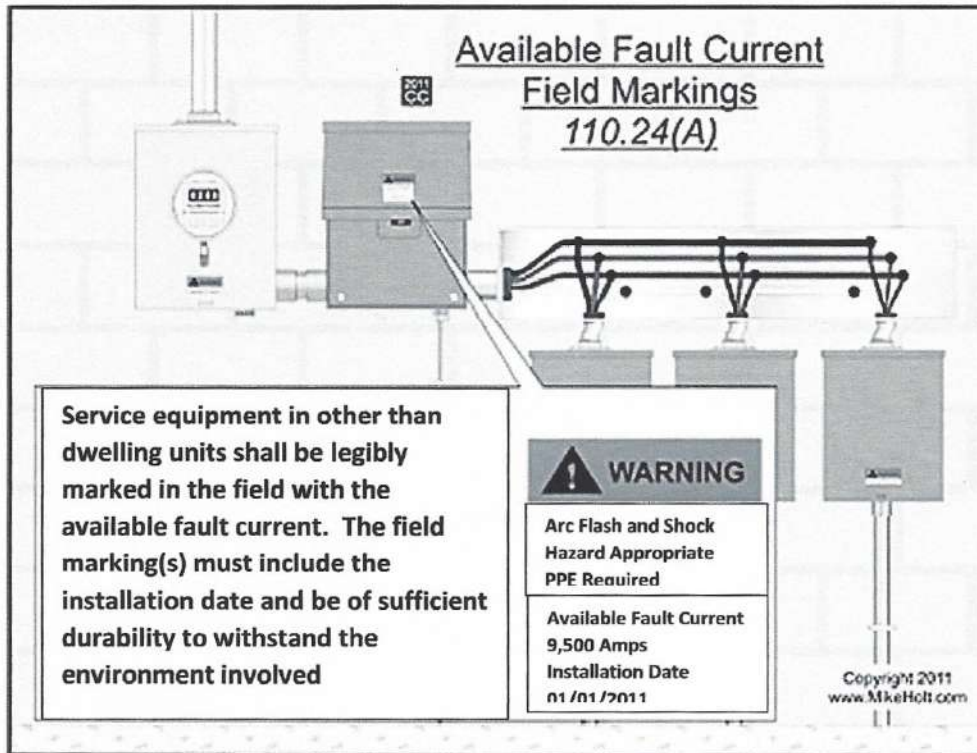

The diagram shows a wall-mounted electrical panel with a meter and a switch. A warning sign is attached to the panel. A text box on the left explains the marking requirements. A copyright notice is at the bottom right.

Service equipment in other than dwelling units shall be legibly marked in the field with the available fault current. The field marking(s) must include the installation date and be of sufficient durability to withstand the environment involved

WARNING
Arc Flash and Shock Hazard Appropriate PPE Required
Available Fault Current 9,500 Amps
Installation Date 01 /01 /2011

Copyright 2011
www.MikeHolt.com

Arc-Flash Hazard Warning
110.16

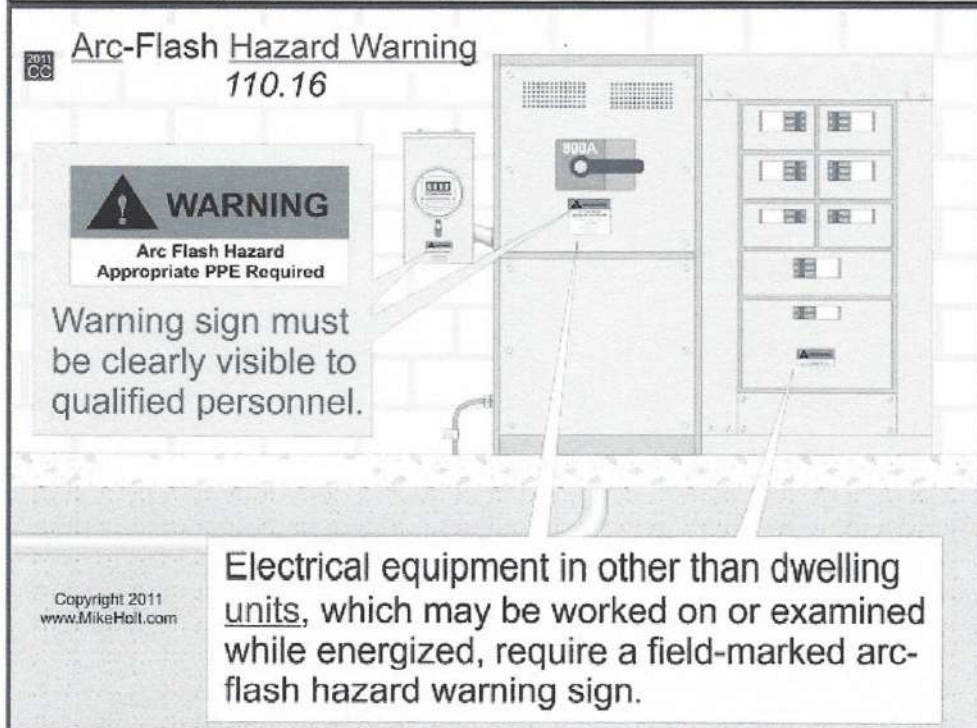

The diagram shows a large electrical cabinet with a switch and a warning sign. A text box on the left explains the sign requirements. A text box at the bottom explains the marking requirements. A copyright notice is at the bottom left.

WARNING
Arc Flash Hazard Appropriate PPE Required

Warning sign must be clearly visible to qualified personnel.

Electrical equipment in other than dwelling units, which may be worked on or examined while energized, require a field-marked arc-flash hazard warning sign.

Copyright 2011
www.MikeHolt.com

WARNING

Arc Flash & Shock Hazard Appropriate PPE Required

<p>Flash Protection</p> <p>Flash Hazard Category 1</p> <p>Incident Energy <u>2.8</u> (cal/cm²)</p> <p>Flash Protection Boundary <u>30 inches</u></p> <p>Glove Class <u>00</u></p> <p>PPE REQUIRED</p> <p>CAT.1 OR 2 FR SHIRT & PANTS, AR FACE SHIELD, SAFETY GLASSES, LEATHER GLOVES, EAR PLUGS</p>	<p>Shock Protection</p> <p><u>480</u> VAC Shock Hazard When Cover is Removed</p> <p>Limited Approach Boundary <u>42 inches</u></p> <p>Restricted Approach Boundary <u>12 inches</u></p> <p>Prohibited Approach Boundary <u>1 inch</u></p> <p><small>*Warning: Changes in equipment settings or system configuration will invalidate the calculated values and PPE requirements. Review every 5 yrs.</small></p>
---	--

February 4, 2010

Bus Name: CLKR-CLR-EF Prot: PD-CLKR-CLR

Old label

E

WARNING

Arc Flash & Shock Hazard Appropriate PPE Required

<p>ARC FLASH HAZARD PROTECTION</p> <p>Hazard Risk Category: 2</p> <p>Incident Energy (cal/cm²): 7.27 at 18 in.</p> <p>Arc Flash Boundary 54 in.</p> <p>208 VAC Shock Hazard When Cover is Removed</p> <p>Shock Protection Boundaries:</p> <p>Limited Approach Boundary: 42 in.</p> <p>Restricted Approach Boundary: 12 in.</p> <p>Prohibited Approach Boundary: 1 in.</p>	<p>PPE Min. Arc Rating For AR PPE (cal/cm²): 8</p> <ul style="list-style-type: none"> <input checked="" type="checkbox"/> AR Jacket & Pants; Shirt & Pants; Coveralls <input checked="" type="checkbox"/> AR Face Shield or Arc Flash Suit Hood <input checked="" type="checkbox"/> Hard Hat <input checked="" type="checkbox"/> Sock Hood (Balaclava) <input checked="" type="checkbox"/> Safety Glasses or Safety Goggles <input checked="" type="checkbox"/> Hearing Protection (ear canal inserts) <input checked="" type="checkbox"/> Leather Gloves <input checked="" type="checkbox"/> Leather Work Shoes
--	--

Equipment ID: 001-Bus Date of Analysis 2/2/2012

New Label

Exception: Labels applied prior to September 30, 2011 are acceptable if they contain the available incident energy or required level of PPE

ANSI Z535 enforceable by OSHA

Components of ANSI Safety Signs

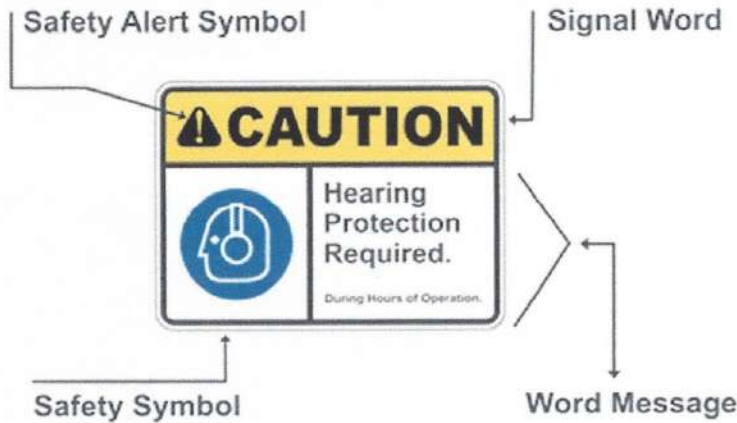

Arc Flash Labels (New 2015)

<p>⚠ DANGER</p> <p>Arc Flash and Shock Hazard Appropriate PPE Required</p> <p>1.2 cal/cm² at 18"</p> <p>Flash Hazard Boundary 18.3 in. Non Melting Protective Clothing, Eye Protection, Hearing Protection Refer to NFPA 70E standards or site specific policies.</p> <p>Shock Hazard When Exposed Limited Approach (Non-Qualified Boundary) 3 ft. 6 in. Restricted Approach (Qualified w/protection) 12 in. Exposed: Class 00 or 0 Gloves, Hardhat and Insulated Tools Where Exposed</p> <p>Equipment: Panel LP2 Study ID: 765-0414 Fed From: MCC 3 Date: April 8, 2015 Fault Current: 3,480 Amps 2015 Workplace Safety Solutions, Inc.</p>	<p>⚠ DANGER</p> <p>Arc Flash and Shock Hazard Appropriate PPE Required</p> <p>7.56 cal/cm² at 18"</p> <p>Flash Hazard Boundary 33.3 in. AR Protective Clothing, Face & Eye Protection, Hearing Protection, Leather Boots, Hardhat Refer to NFPA 70E standards or site specific policies.</p> <p>Shock Hazard When Exposed Limited Approach (Non-Qualified Boundary) 480 Volts 3 ft. 6 in. Restricted Approach (Qualified w/protection) 12 in. Exposed: Class 00 or 0 Gloves, Insulated Tools</p> <p>Equipment: Panel PPI Study ID: 765-0414 Fed From: MCC 3 Date: April 8, 2015 Fault Current: 9,380 Amps 2015 Workplace Safety Solutions, Inc.</p>
<p>⚠ DANGER</p> <p>Arc Flash and Shock Hazard Appropriate PPE Required</p> <p>18.14 cal/cm² at 24"</p> <p>Flash Hazard Boundary 33.3 in. AR Protective Clothing, Face & Eye Protection, Hearing Protection, Leather Boots, Hardhat Refer to NFPA 70E standards or site specific policies.</p> <p>Shock Hazard When Exposed Limited Approach (Non-Qualified Boundary) 4160 Volts 5 ft. Restricted Approach (Qualified w/protection) 2ft. 2 in. Exposed: Class 2 Gloves, Insulated Tools, Grounds Set</p> <p>Equipment: ATS Study ID: 765-0414 Fed From: MDP5 Date: April 8, 2015 Fault Current: 22,360 Amps 2015 Workplace Safety Solutions, Inc.</p>	<p>⚠ DANGER</p> <p>Arc Flash and Shock Hazard Appropriate PPE Required</p> <p>52 cal/cm² at 18"</p> <p>Flash Hazard Boundary 92 in. Wear Arc Flash Suit with Hood for protection to test and verify equipment is de-energized Energized work not recommended</p> <p>Shock Hazard When Exposed Limited Approach (Non-Qualified Boundary) 480 Volts 3' - 6" Restricted Approach (Qualified w/protection) 12" Exposed Parts: Class 00 or 0 Gloves, Insulated Tools</p> <p>Equipment: MCC Study ID: 765-0414 Fed From: Main Disconnect M2 Date: April 8, 2015 Fault Current: 62,380 Amps 2015 Workplace Safety Solutions, Inc.</p>

PPE Category Level Chart 2015

NFPA 70E

Page 36

Category

1

Arc-Rated Clothing, Minimum Arc Rating of 4 cal/cm^2
Arc-rated long-sleeve shirt and pants or arc rated coverall
Arc-rated face shield or arc flash suit hood
Arc-rated jacket, parka, rainwear, or hard hat liner (AN)
Hard hat
Safety glasses or safety goggles (SR)
Hearing protection (ear canal inserts)
Heavy duty leather gloves and leather footwear (AN)



Category

2

Arc-Rated Clothing, Minimum Arc Rating of 8 cal/cm^2
Arc-rated long-sleeve shirt and pants or arc rated coverall
Arc-rated flash suit hood or arc-rated face shield and arc rated balaclava
Arc-rated jacket, parka, rainwear, or hard hat liner (AN)
Hard hat
Safety glasses or safety goggles (SR)
Hearing protection (ear canal inserts)
Heavy duty leather gloves and Leather footwear (AN)



Category

3

Arc-Rated Clothing Selected so That the System Arc Rating Meets the Required Minimum Arc Rating of 25 cal/cm^2
Arc-rated long-sleeve shirt (AR) and arc rated pants (AR)
Arc-rated coverall (AR) and arc-rated flash suit jacket (AR)
Arc-rated arc flash suit pants (AR) and arc-rated arc flash suit hood
Arc-rated gloves, arc-rated jacket, parka, rainwear, or hard hat liner (AN)
Hard Hat, Safety glasses or safety goggles (SR)
Hearing protection (ear canal inserts)
Leather footwear (AN)



Category

4

Arc-Rated Clothing Selected so That the System Arc Rating Meets the Required Minimum Arc Rating of 40 cal/cm^2
Arc-rated long-sleeve shirt (AR) and arc rated pants (AR)
Arc-rated coverall (AR) and arc-rated flash suit jacket (AR)
Arc-rated arc flash suit pants (AR) and arc-rated arc flash suit hood
Arc-rated gloves, arc-rated jacket, parka, rainwear, or hard hat liner (AN)
Hard Hat, Safety glasses or safety goggles (SR)
Hearing protection (ear canal inserts)
Leather footwear



AN: as needed (optional), AR: as required, SR: selection required. NFPA 70E 2015 Table 130.7(C)(16) Personal Protective Equipment (PPE)



Toll-Free
800-381-4389

Visit us online at:
goITU.com

page 36

Informative Annex H Guidance on Selection of Protective Clothing and Other Personal Protective Equipment (PPE)

This informative annex is not a part of the requirements of this NFPA document but is included for informational purposes only.

H.1 Arc-Rated Clothing and Other Personal Protective Equipment (PPE) for Use with arc flash PPE categories

Table 130.7(C)(15)(A)(a), Table 130.7(C)(15)(A)(b), Table 130.7(C)(15)(B) and Table 130.7(C)(16) provide guidance for the selection and use of PPE when using arc flash PPE categories

H.2 Simplified Two-Category Clothing Approach for

Use with Table 130.7(C)(15)(A)(a), Table 130.7(C)(15)(A)(b), Table 130.7(C)(15)(B) and Table 130.7(C)(16). The use of Table H.2 is a simplified approach to provide minimum PPE for electrical workers within facilities with large and diverse electrical systems. The clothing listed in Table H.2 fulfills the minimum arc-rated clothing requirements of Table 130.7(C)(15)(A)(a)

Table 130.7(C)(15)(A)(b), Table 130.7(C)(15)(B) and Table 130.7(C)(16). The clothing systems listed in this table should be used with the other PPE appropriate for the arc flash PPE category [see Table 130.7(C)(16)]. The notes to Table 130.7(C)(15)(A)(a), Table 130.7(C)(15)(A)(b), and Table 130.7(C)(15)(B), must apply as shown in those tables.

H.3 Arc-Rated Clothing and Other Personal Protective Equipment (PPE) for Use with Risk Assessment of Electrical Hazards.

Table H.3(a) provides a summary of specific sections within the NFPA 70E standard describing PPE for electrical hazards. Table H.3(b) provides guidance on the selection of arc-rated and other PPE for users who determine the incident energy exposure (in cal/cm²).

Table H.2 Simplified Two-Category, Arc-Rated Clothing System

Clothing*	Applicable Tasks
Everyday Work Clothing Arc-rated long-sleeve shirt with arc-rated pants (minimum arc rating of 8) <i>or</i> Arc-rated coveralls (minimum arc rating of 8)	All arc flash PPE category 1 and arc flash PPE category 2 tasks listed in Table 130.7(C)(15)(A)(a) and Table 103.7(C)(15)(A)(b) and Table 130.7(C)(15)(B)
Arc Flash Suit A total clothing system consisting of arc-rated shirt and pants and/or arc-rated coveralls and/or arc flash coat and pants (clothing system minimum arc rating of 40)	All arc flash PPE category 3 and arc flash PPE category 4 tasks listed in Table 130.7(C)(15)(A)(a) and Table 130.7(C)(15)(B)

*Note that other PPE listed in table 130.7(C)(16), which include arc-rated face shields or arc flash suit hoods, arc-rated hard hat liners, safety glasses or safety goggles, hard hats, hearing protection, heavy-duty leather gloves, rubber insulated gloves and leather protectors could be required. The arc rating for a garment is expressed in cal/cm².

The estimated available short-circuit current capacities and fault clearing time or arcing durations are listed in the text or Table 130.7(C)(15)(A)(a) and Table 130.7(C)(15)(B). Various tasks are listed in Table 130.7(C)(15)(A)(a) For tasks not listed or for power systems with greater than the estimated available short-circuit capacity or with longer than the assumed fault clearing times or arcing durations, an arc flash risk assessment is required in accordance with 130.5.

Tables H.3(a) and (b) were revised by a tentative interim amendment (TIA). See page 1.

Table H.3(a) Summary of Specific Sections Describing PPE for Electrical Hazards

Shock Hazard PPE	Applicable Section(s)
Rubber insulating gloves and leather protectors (unless the requirements of ASTM F 496 are met)	130.7(C)(7)(a)
Rubber insulating sleeves (as needed)	130.7(C)(7)(a)
Class G or E hard hat (as needed)	130.7(C)(3)
Safety glasses or goggles (as needed)	130.7(C)(4)
Dielectric overshoes (as needed)	130.7(C)(8)

Table H.3(a) Summary of Specific Sections Describing PPE for Electrical Hazards

Arc Flash Hazard PPE	Applicable Section(s)
<i>Incident energy exposures up to 1.2 cal/cm²</i>	
Clothing: nonmelting or untreated natural fiber long-sleeve shirt and long pants or coverall	130.7(C)(1); 130.7(C)(9)(d)
Gloves: heavy-duty leather	130.7(C)(7)(b); 130.7(C)(10)(d)
Hard hat: class G or E	130.7(C)(3)
Face shield: covers the face, neck, and chin (as needed)	130.7(C)(3)
Safety glasses or goggles	130.7(C)(4); 130.7(C)(10)(c)
Hearing protection	130.7(C)(5)
Footwear heavy-duty leather (as needed)	130.7(C)(10)(e)
<i>Incident Energy Exposures \geq 1.2 cal/cm²</i>	
Clothing: arc-rated clothing system with an arc rating appropriate to the anticipated incident energy exposure	130.7(C)(1); 130.7(C)(2); 130.7(C)(6); 130.7(C)(9)(d)
Clothing underlayers (when used): arc-rated or nonmelting untreated natural fiber	130.7(C)(9)(c); 130.7(C)(11); 130.7(C)(12)
Gloves:	130.7(C)(7)(b); 130.7(C)(10)(d)
Exposures \geq 1.2 cal/cm ² and \leq 8 cal/cm ² : heavy-duty leather gloves	
Exposures $>$ 8 cal/cm ² : rubber insulating gloves with their leather protectors; or arc-rated gloves	
Hard hat: class G or E	130.7(C)(1); 130.7(C)(3)
Face shield:	130.7(C)(1); 130.7(C)(3); 130.7(C)(10)(a); 130.7(C)(10)(b); 130.7(C)(10)(c)
Exposures \geq 1.2 cal/cm ² and 12 cal/cm ² : arc-rated face shield that covers the face, neck, and chin and an arc-rated balaclava or an arc-rated arc flash suit hood	
Exposures $>$ 12 cal/cm ² : arc-rated arc flash suit hood	
Safety glasses or goggles	130.7(C)(4); 130.7(C)(10)(c)
Hearing protection	130.7(C)(5)
Footwear:	130.7(C)(10)(e)
Exposures \leq 4 cal/cm ² : heavy-duty leather Footwear (as needed)	
Exposures $>$ 4 cal/cm ² : heavy-duty leather Footwear	

Donnie's Accident

My name is Donnie Johnson. I am the assistant manager of the Service Department for an electrical contractor. I've been an electrician for 28 years and I have a wonderful family. I told my wife once, just before we got married, that as long as I have these (hands) we will always have money. On Thursday, August 12th 2004, I almost lost all of this forever in an electrical explosion or "ARC BLAST". I had 3rd degree burns down to the muscle on both arms and hands and second degree burns to my face, head and neck.

I'm not offering 'arc flash' education or providing safety rules or guidelines, I am simply telling what could happen if you don't follow your safety procedures. This is about my personal experiences before, during and since the accident. Also how it affects you and those who care about and depend on you. My most severe injuries were totally preventable... if ... I had been following the safety procedures and wearing the proper PPE (Personal Protective Equipment). A lot of safety procedures were put in place because of accidents like mine.

All of this happened to me, because I wasn't wearing my safety gear.

I have sat through safety meetings before, thinking the whole time that the only reason for the meeting was to meet some company insurance requirement or the company just trying to cover itself in case an accident happened. Once this happened to me, I realized whether or not this was the case, the things they were saying could have protected me. Honestly, if I had been wearing the personal protection equipment that was provided for me, that I was trained to use and still in the PPE bag between the front seats of my van; my trip to the hospital would have probably been just for a check-up and a few, minor burns. Although my injuries were electrical in nature, whether you are a plumber, a carpenter or a mason there are safety procedures that could protect you from injury or save your life.

As a service electrician, my duties included general trouble shooting of electrical systems. Anything from Mrs. Smith's light switches to high-voltage work. It was the day before the first of four hurricanes that hit Florida in 2004, Thursday, August 12th. I was wiring a large, semi-trailer mounted generator to a giant frozen foods warehouse electrical system. I had the wiring in place and terminated. This is the point where I should have pulled out my fully stocked PPE bag. But I did not, due to having performed similar tests many times before and thinking "what could possibly happen as long as I am careful" and "all that gear is so hot and bulky". This was the first problem that led to the accident. The second problem was the meter I had been using for several months to check rotation was not actually a phase rotation meter but a motor rotation meter. I had never bothered to read the 'not to be used on live circuits' label on the bottom of the meter. I checked the electrical rotation on the 480volt generator. I went inside the electrical room to check the building electrical rotation. I had to get to the main buss of an energized 480volt/3,000amp switch gear in order to get an accurate reading. I proceeded to open the electrical cabinet panel that would give me direct access to the main buss. I connected the first of three meter leads with large alligator type clips to the "A" phase main buss in the gear, the second clip to the "B" phase, as I clipped or started to clip the third clip, the meter failed and



blew a puff of carbon into the electrical gear.

This is the equivalent of throwing a cup of water into the electrically energized gear.... The carbon set off a carbon arc between the three phases in the switch gear, shorting all three phases together and causing an explosion with an arc flash or blast. All of this happened in a split second. As I was being blown to the ground I actually saw a two to three foot, ball of white light or basically a ball of lightning.

The burn doctors and several arc flash experts have told me since that an arc flash explosion like this can be seven times as hot as the sun's surface for a split second. The doctors were amazed later that my eyes were not injured, that my hearing was not damaged, because of the loud explosion from the erupting heat and I didn't inhale heat or metals (which vaporize at these temperatures) burning my lungs then solidifying. I joked with them saying "I couldn't inhale because I was SCREAMING LIKE A LITTLE GIRL". Getting back to the accident.... I remember hearing some sizzling noise and seeing few glowing orange spots or slag, other than that it was pitch black. I could see daylight from around the exterior door of the room and I just started heading that way. I scrambled on my finger tips and toes and it felt as if something had a hold on my belt loop, like I couldn't move fast enough. There had been two maintenance men from this facility in the electric room with me but they were on the other side of the equipment. I called out there names but didn't hear a response. I found out later from them that they had gotten out just as the explosions started and that it had been a little longer than I had recalled from the actual explosion until I found my way out of the building. I remember standing up outside and realizing that I was hurt but I still didn't fathom how bad. I thought to myself that this kind of thing 'doesn't happen to me'. I looked up at the building and listened and realized that the power was off, thinking "oh NO, this is where all the frozen food in Tampa is stored before it gets to the grocery stores!" "Maybe I can jump the generator wiring directly to the switch gear to get them at least some power back on". Like I said I didn't realize how badly I was hurt and I'm sure shock had set in. Just then I turned around and saw several people from the warehouse management running towards me. I said something about the power and they said "forget the power, get him in the cooler". They kind of corralled around me and led me into the freezer warehouse. I was now starting to realize just how badly I had been injured. The odd thing was that I was still conscious, carrying on conversations and not in pain. I found out later that with burns as severe as mine, the small nerve endings are damaged and you do not 'feel' the pain. Finally looking at my arms and hands, I knew I couldn't even try to stick them in my pockets to reach my phone. I

also realized that the side of my head had been burnt. I asked one of the guys to fish my phone from my pocket, call my wife and hold it up to my good ear. After looking up at my ears, he gave me the blindest stare I have ever seen. He said "you have a good ear!" I could see fright in his eyes so I assured him that I was ok, to tell my wife I'd been in an accident but that I was up, walking, talking and that I would be transported to Tampa General Hospital. I remember actually telling the guy that was helping me to go throw my gloves and safety equipment into the electrical room so that it looked like I had at least made an attempt to follow safety procedures. Very Sad.

I continued talking and even trying to joke with the guys until the ambulance arrived. The paramedics came in and had me lie down on a pallet of boxes. They proceeded to cut my shirt away from my body and cut my jeans up each pant leg. They were discussing calling in a helicopter medi-vac. I thought, "Wow, I had never been in a helicopter before". Like I've said already... I was in shock. The paramedics decided to transport me by ground. As they moved me from the freezer into the ambulance at normal outside temperatures, it wasn't really pain but the heat overwhelmed me! I remember telling the medic "Man, You have to do something its 900 degrees!" I saw him flick a syringe a couple of times as he said "don't worry Mr. Johnson; we'll take care of you". After that I dimly remember the bumpy ride to the hospital.

My wife and one of the owners of my company were waiting at the emergency room drive through, checking each ambulance as they pulled up. My wife recognized my boots sitting near the stretcher in the in the ambulance, otherwise I was not recognizable. As they wheeled me into the hospital vaguely remember seeing my wife.

The doctors surrounded me they told my wife that if she needed to talk to me, she must to do it now because they needed to insert a breathing tube and further sedate me. Because of the swelling from the burns my wind pipe would soon swell shut. She called my name, I told her I love her and that I didn't understand what happened.

All of this happened, because I wasn't wearing my safety gear.

I must tell you that from this point on I am relying on the journal my wife wrote and the experience of my family and friends. I personally don't remember anything else for about a month and half. After the breathing tube was inserted and I was sedated, the doctors had to make an incision the entire length of each arm in order to relieve the swelling. They told my wife that I should be out of the hospital in about two weeks.

And remember, all the while, Hurricane Charlie was barreling for Tampa! My company sent a crew over to secure my yard. The next day the area we live in was evacuated. I couldn't be there to provide help or 'be the man for my family'. Tampa general hospital had limited access for employees only since the bridges might flood. Over the next couple of days I became very swollen and was looking bad. My dad came to see me for the first time, and a usually unemotional man was visibly upset. On the fifth day the surgeons grafted skin from my right leg to my right arm. All went well and I was due to have the breathing tube removed within a day or two. My mother and step father came to Tampa to help my wife. The next day, my blood pressure dropped extremely low and my heart rate increased significantly. The doctors tested for infection. Test results would not be back for two days. My brother came to town as I was not looking good. While waiting for the test results and my health was deteriorating, all my wife could do was worry. The test results showed I had an E coli infection in my lungs. This would be the first of many infections. Your skin is your main protection from infection, and with the burns

on my arms, the grafting on my legs and the breathing tube, it was open season on me for every infection that came along. These infections slowed the healing process of my injuries to almost a stand still. I developed pneumonia and blood infections. A decision was made to graft my left arm as well because the burns were not healing as expected. My health continued to falter. The infections, wounds and the medicines also prevented me from receiving tube feeding, so my only source of nourishment was an IV drip.

All of this happened, because I wasn't wearing my safety gear.

During this time several friends, co-workers and family members, some that I hadn't seen in years came to comfort and help my family. Meanwhile, their homes on the east coast of Florida were being damaged by hurricanes Francis and Jeanie. I was amazed when I learned about this later, that they were more concerned with my family and me than their own homes.

After several weeks of the doctors telling my wife "that they had never seen anything like the complications I was having" and "to go home and pray", she called a meeting with all of the medical departments that were involved with my case. She pleaded with them to find some answer to save me. They found that I was allergic to one of the medicines they were treating me with. The reaction was causing complete organ failure. They used two other drugs, not meant for this purpose, with my wife's permission to correct the reaction. There was only one other person who has had the reaction to this medicine, so this was a complete risk with no guarantee. Luckily it began to work.

When I entered the hospital I was a very fit 165lbs. When I awoke from the coma, after a month and a half, I weighed 115lbs. And was still not allowed to eat because of severe pancreatitis and fear of how my digestive system would react. My arms and legs were as small as my 9 year old son's and were thickly bandaged. The pain from the actual burns was over but the graft sites on my legs caused intense pain. All the guys I work with and supervisors came to visit whenever they could. I could see the introspection in the eyes of the electricians.

All of this happened, because I wasn't wearing my safety gear.

The sedation drugs seemed to take weeks to completely wear off. Rehabilitation started almost immediately. I had to build the atrophied muscles in my legs back up in order to be able to walk. It would take over a year and a half of therapy to be able to use my hands and arms because of the scarring. During this time I had surgery on my hand to relieve scar bands and I almost lost my thumb. My wind pipe was also collapsing from scar tissue caused by the breathing tube being in for so long. A surgeon removed about a one inch section of my trachea. And following my prior medical experience, I developed an infection and it ruptured the stitches that held the re-section together. I had a tracheotomy, with a tube inserted to bypass the surgical site to allow it to heal. It remained in for two months. Then they performed another surgery to close the tracheotomy opening.

Once it became obvious that I would not be able to return to work as an electrician, my employer and my supervisor offered me the opportunity to become a project manager and help supervise the men I used to work side by side with. I started back to work in the office at the beginning of 2006.

As you can see this wasn't just my experience but all my family, friends and coworkers were effected as well. I am not able today to do the work that I did and loved or to use my hands to

the extent I once could. My hands and arms have no feeling, no sweat glands, no hair and no pores. The new skin is also very thin and highly susceptible to injury and skin cancer. Your arms are also a major source of cooling for your body. I must wear long sleeves or sun protection at all times. I'm not really able to enjoy sports or events in the sun. Being a native Floridian, this is very different than I used to live my life. BUT ... There are those who have suffered much greater injuries or death from very similar accidents. I am a very lucky and blessed man to even be alive! All of this because I took safety for granted. I didn't follow safety procedures or wear my personal protection equipment.

All of this happened, because I wasn't wearing my safety gear.

When someone complains about the safety gear being hot, uncomfortable or too bulky, I pull up my sleeves and tell them "it's a hell of a lot more comfortable than living with this for the rest of your life... If you make it."

All I am asking you to do is to protect yourself and those working around you by following your safety procedures. Accidents at work not only affect you; think about the effects on your family, your friends, your finances, your company, your co-workers... your entire world. Most of these injuries can be prevented by following your safety rules. Most of these rules were put in place because of accidents like mine. Be safe; do it for yourself and for all the people close to you.

O.1 Introduction.

This informative annex addresses the responsibilities of the facility owner or manager or the employer having responsibility for facility ownership or operations management to perform a risk assessment during the design of electrical systems and installations.

O.1.1 This informative annex covers employee safety-related design concepts for electrical equipment and installations in workplaces covered by the scope of this standard. This informative annex discusses design considerations that have impact on the application of the safety-related work practices only.

O.1.2 This informative annex does not discuss specific design requirements. The facility owner or manager or the employer should choose design options that eliminate hazards or reduce risk and enhance the effectiveness of safety-related work practices.

O.2 General Design Considerations.

O.2.1 Employers, facility owners, and managers who have responsibility for facilities and installations having electrical energy as a potential hazard to employees and other personnel should ensure that electrical hazards risk assessments are performed during the design of electrical systems and installations.

O.2.2 Design option decisions should facilitate the ability to eliminate hazards or reduce risk by doing the following:

- (1) Reducing the likelihood of exposure
- (2) Reducing the magnitude or severity of exposure
- (3) Enabling achievement of an electrically safe work condition

O.2.3 Incident Energy Reduction Methods. The following methods have proved to be effective in reducing incident energy:

- (1) Zone-selective interlocking. A method that allows two or more circuit breakers to communicate with each other so that a short circuit or ground fault will be cleared by the breaker closest to the fault with no intentional delay. Clearing the fault in the shortest time aids in reducing the incident energy.
- (2) Differential relaying. The concept of this protection method is that current flowing into protected equipment must equal the current out of the equipment. If these two currents are not equal, a fault must exist within the equipment, and the relaying can be set to operate for a fast interruption. Differential relaying uses current transformers located on the line and load sides of the protected equipment and fast acting relay.
- (3) Energy-reducing maintenance switching with a local status indicator. An energy-reducing maintenance switch allows a worker to set a circuit breaker trip unit to operate faster while the worker is working within an arc flash boundary, as defined in NFPA 70E, and then to set the circuit breaker back to a normal setting after the work is complete.

O.2.4 Other Methods.

- (1) Energy-reducing active arc flash mitigation system. This system can reduce the arcing duration by creating a low impedance current path, located within a controlled compartment, to cause the arcing fault to transfer to the new current path, while the upstream breaker clears the circuit. The system works without compromising existing selective coordination in the electrical distribution system.

- (2) Arc flash relay. An arc flash relay typically uses light sensors to detect the light produced by an arc flash event. Once a certain level of light is detected the relay will issue a trip signal to an upstream overcurrent device.
- (3) High-resistance grounding. A great majority of electrical faults are of the phase-to-ground type. High-resistance grounding will insert an impedance in the ground return path and will typically limit the fault current to 10 amperes and below (at 5 kV nominal or below), leaving insufficient fault energy and thereby helping reduce the arc flash hazard level. High-resistance grounding will not affect arc flash energy for line-to-line or line-to-line-to-line arcs.
- (4) Current-limiting devices. Current-limiting protective devices reduce incident energy by clearing the fault faster and by reducing the current seen at the arc source. The energy reduction becomes effective for current above the current-limiting threshold of the current-limiting fuse or current limiting circuit breaker.

The Occupational Safety and Health Administration (OSHA) has standards addressing electrical hazards, yet hundreds of fatalities and thousands of injuries still occur as a result of electric shock, electrocution, arc flash and arc blast each year. To help mitigate these hazards, OSHA encouraged the industry, through the National Fire Protection Association (NFPA), to establish NFPA 70E, Standard for Electrical Safety in the Workplace. While the first edition was released in 1979, familiarity with NFPA 70E varies. A brief quiz follows to test your knowledge of the standard. It may demonstrate the need for deeper study.

1. The fundamental premise of NFPA 70E is that a qualified person must decide whether work can be performed energized.

False. NFPA 70E mandates all work to be performed de-energized unless justification is provided. It is not a choice. Work can only be performed energized or “hot” under the following conditions:

- The circuit is less than 50 volts, and overcurrent protection prevents any increase in exposure to electric arcs.
- Working de-energized will create a greater hazard, and the rules and guidelines are specific on what this constitutes. Examples cited include interruption of life support equipment, deactivation of emergency alarm systems, and shutdown of hazardous location ventilation equipment.
- Tasks are infeasible to perform unless the circuit or part is energized, such as in diagnostics and testing, or for circuits that form an integral part of a continuous process that would otherwise need to be completely shut down. Inconvenience should not be mistaken for infeasibility, and caution must be used.

If these conditions are not in place, all circuit parts and equipment must be placed in an electrically safe working condition using a proper lockout/tagout procedure.

2. Journeyman electricians are considered a qualified person based on the definition in NFPA 70E.

False. According to NFPA 70E, a qualified person “has skills and knowledge related to the construction and operation of the electrical equipment and installations and has received safety training to recognize and avoid the hazards involved.” A qualified electrician or journeyman has knowledge and skills for a wide variety of tasks. If unfamiliar with a particular piece of equipment, they fall short of the definition. To ensure qualification, identify the hazards associated with those tasks, along with the specific skills and knowledge employees need. Compare those requirements to the actual skills and knowledge of the employee scheduled to perform the work, and provide any training needed to fill the gaps.

3. The arc flash boundary (AFB) can be greater than the limited approach boundary (LAB).

True. The LAB is based on the shock hazard. The AFB is based on the injury a worker could receive if an arc were to occur. More specifically, the formula for the AFB is the distance at which a person could receive a second-degree burn or where the incident energy is 1.2 calories/cm². This distance may be greater or less than the limited approach.

4. An arc flash hazard analysis may be performed using an incident energy (calculation) method or the hazard/risk category (table) method using Table 130.7(C)(15)(a) for alternating current and Table 130.7(C)(15)(b) for direct current.

True. NFPA 70E finds either method acceptable. Annex D offers various formulas for use depending on the voltage. The tables are specific to certain tasks and conditions. When using the table method, check the footnotes for parameters, such as voltage range and clearing times.

5. OSHA can cite employees for failure to comply with a section of NFPA 70E.

False. This response needs to be qualified. NFPA 70E is a consensus standard, which means citations cannot be issued for it. However, OSHA is able to use it to support a citation. NFPA 70E has been used for citations under the General Duty clause 5(a)(1) and 29 CFR 1910.335(a)(1)(i). Under 5(a)(1) of the OSH Act, an employer "shall furnish to each of his employees employment and a place of employment which are free from recognized hazards that are causing or are likely to cause death or serious physical harm to his employees." Section 1910.335(a)(1)(i) states, "Employees working in areas where there are potential electrical hazards shall be provided with, and shall use, electrical protective equipment that is appropriate for the specific parts of the body to be protected and for the work to be performed." NFPA 70E offers evidence of a hazard that it is feasible to abate it.

Even if you knew all the answers, continue to review NFPA 70E, as updates account for the latest technical information. For more about NFPA 70E or to buy a copy, visit www.nfpa.org. See www.osha.gov for OSHA's electrical regulations.

Source URL: <http://www.ecmag.com/section/safety/nfpa-70e-review>

OSHA www.OSHA.gov

Cal-OSHA www.dir.ca.gov

NFPA www.nfpa.org

Westex www.westex.com

ITU www.goitu.com

Hugh Hoagland www.arcwear.com

Oberon www.labsafety.com

www.arcflashengineering.com

<http://arcflashsupply.com>

Lewellyn www.lewellyn.com

Electrical Contractor Magazine www.ECMag.com

6425. (a) Any employer and any employee having direction, management, control, or custody of any employment, place of employment, or of any other employee, who willfully violates any occupational safety or health standard, order, or special order, or Section 25910 of the Health and Safety Code, and that violation caused death to any employee, or caused permanent or prolonged impairment of the body of any employee, is guilty of a public offense punishable by imprisonment in a county jail for a term not exceeding one year, or by a fine not exceeding one hundred thousand dollars (\$100,000), or by both that imprisonment and fine; or by imprisonment in the state prison for 16 months, or two or three years, or by a fine of not more than two hundred fifty thousand dollars (\$250,000), or by both that imprisonment and fine; and in either case, if the defendant is a corporation or a limited liability company, the fine may not exceed one million five hundred thousand dollars (\$1,500,000).

(b) If the conviction is for a violation committed within seven years after a conviction under subdivision (b), (c), or (d) of Section 6423 or subdivision (c) of Section 6430, punishment shall be by imprisonment in state prison for a term of 16 months, two, or three years, or by a fine not exceeding two hundred fifty thousand dollars (\$250,000), or by both that fine and imprisonment, but if the defendant is a corporation or limited liability company, the fine may not be less than five hundred thousand dollars (\$500,000) or more than two million five hundred thousand dollars (\$2,500,000).

(c) If the conviction is for a violation committed within seven years after a first conviction of the defendant for any crime involving a violation of subdivision (a), punishment shall be by imprisonment pursuant to subdivision (h) of Section 1170 of the Penal Code for two, three, or four years, or by a fine not exceeding two hundred fifty thousand dollars (\$250,000), or by both that fine and imprisonment, but if the defendant is a corporation or a limited liability company, the fine shall not be less than one million dollars (\$1,000,000) but may not exceed three million five hundred thousand dollars (\$3,500,000).

(d) In determining the amount of fine to be imposed under this section, the court shall consider all relevant circumstances, including, but not limited to, the nature, circumstance, extent, and gravity of the violation, any prior history of violations by the defendant, the ability of the defendant to pay, and any other matters the court determines the interests of justice require.

(e) As used in this section, "willfully" has the same definition as it has in Section 7 of the Penal Code. This subdivision is intended to be a codification of existing law.

(f) This section does not prohibit a prosecution under Section 192 of the Penal Code.

Informative Annex K General Categories of Electrical Hazards

This informative annex is not a part of the requirements of this NFPA document but is included for informational purposes only.

K.1 General Categories. There are three general categories of electrical hazards: electrical shock, arc flash, and arc blast.

K.2 Electric Shock. Approximately 30,000 nonfatal electrical shock accidents occur each year. The National Safety Council estimates that about 1000 fatalities each year are due to electrocution, more than half of them while servicing energized systems of less than 600 volts.

Electrocution is the fourth leading cause of industrial fatalities, after traffic, homicide, and construction accidents. The current required to light a 7½-watt, 120-volt lamp, if passed across the chest, is enough to cause a fatality. The most damaging paths through the body are through the lungs, heart, and brain.

K.3 Arc Flash. When an electric current passes through air between ungrounded conductors or between ungrounded

conductors and grounded conductors, the temperatures can reach 35,000°F. Exposure to these extreme temperatures both burns the skin directly and causes ignition of clothing, which adds to the burn injury. The majority of hospital admissions due to electrical accidents are from arc flash burns, not from shocks. Each year more than 2000 people are admitted to burn centers with severe arc flash burns. Arc flashes can and do kill at distances of 3 m (10 ft).

K.4 Arc Blast. The tremendous temperatures of the arc cause the explosive expansion of both the surrounding air and the metal in the arc path. For example, copper expands by a factor of 67,000 times when it turns from a solid to a vapor. The danger associated with this expansion is one of high pressures, sound, and shrapnel. The high pressures can easily exceed hundreds or even thousands of pounds per square foot, knocking workers off ladders, rupturing eardrums, and collapsing lungs. The sounds associated with these pressures can exceed 160 dB. Finally, material and molten metal are expelled away from the arc at speeds exceeding 1120 km/hr (700 mph), fast enough for shrapnel to completely penetrate the human body.