

# IAEA SAFETY STANDARDS SERIES

## Regulations for the Safe Transport of Radioactive Material

1996 Edition (As Amended 2003)

## SAFETY REQUIREMENTS

No. TS-R-1



**IAEA**  
International Atomic Energy Agency

# IAEA SAFETY RELATED PUBLICATIONS

## IAEA SAFETY STANDARDS

Under the terms of Article III of its Statute, the IAEA is authorized to establish standards of safety for protection against ionizing radiation and to provide for the application of these standards to peaceful nuclear activities.

The regulatory related publications by means of which the IAEA establishes safety standards and measures are issued in the **IAEA Safety Standards Series**. This series covers nuclear safety, radiation safety, transport safety and waste safety, and also general safety (that is, of relevance in two or more of the four areas), and the categories within it are **Safety Fundamentals**, **Safety Requirements** and **Safety Guides**.

**Safety Fundamentals** (blue lettering) present basic objectives, concepts and principles of safety and protection in the development and application of nuclear energy for peaceful purposes.

**Safety Requirements** (red lettering) establish the requirements that must be met to ensure safety. These requirements, which are expressed as 'shall' statements, are governed by the objectives and principles presented in the Safety Fundamentals.

**Safety Guides** (green lettering) recommend actions, conditions or procedures for meeting safety requirements. Recommendations in Safety Guides are expressed as 'should' statements, with the implication that it is necessary to take the measures recommended or equivalent alternative measures to comply with the requirements.

The IAEA's safety standards are not legally binding on Member States but may be adopted by them, at their own discretion, for use in national regulations in respect of their own activities. The standards are binding on the IAEA in relation to its own operations and on States in relation to operations assisted by the IAEA.

Information on the IAEA's safety standards programme (including editions in languages other than English) is available at the IAEA Internet site

[www-ns.iaea.org/standards/](http://www-ns.iaea.org/standards/)

or on request to the Safety Co-ordination Section, IAEA, P.O. Box 100, A-1400 Vienna, Austria.

## OTHER SAFETY RELATED PUBLICATIONS

Under the terms of Articles III and VIII.C of its Statute, the IAEA makes available and fosters the exchange of information relating to peaceful nuclear activities and serves as an intermediary among its Member States for this purpose.

Reports on safety and protection in nuclear activities are issued in other series, in particular the **IAEA Safety Reports Series**, as informational publications. Safety Reports may describe good practices and give practical examples and detailed methods that can be used to meet safety requirements. They do not establish requirements or make recommendations.

Other IAEA series that include safety related publications are the **Technical Reports Series**, the **Radiological Assessment Reports Series**, the **INSAG Series**, the **TECDOC Series**, the **Provisional Safety Standards Series**, the **Training Course Series**, the **IAEA Services Series** and the **Computer Manual Series**, and **Practical Radiation Safety Manuals** and **Practical Radiation Technical Manuals**. The IAEA also issues reports on radiological accidents and other special publications.

REGULATIONS  
FOR THE SAFE TRANSPORT  
OF RADIOACTIVE MATERIAL

1996 Edition (As Amended 2003)

Safety Standards Series No. TS-R-1

The following States are Members of the International Atomic Energy Agency:

AFGHANISTAN	GREECE	PARAGUAY
ALBANIA	GUATEMALA	PERU
ALGERIA	HAITI	PHILIPPINES
ANGOLA	HOLY SEE	POLAND
ARGENTINA	HONDURAS	PORTUGAL
ARMENIA	HUNGARY	QATAR
AUSTRALIA	ICELAND	REPUBLIC OF MOLDOVA
AUSTRIA	INDIA	ROMANIA
AZERBAIJAN	INDONESIA	RUSSIAN FEDERATION
BANGLADESH	IRAN, ISLAMIC REPUBLIC OF	SAUDI ARABIA
BELARUS	IRAQ	SENEGAL
BELGIUM	IRELAND	SERBIA AND MONTENEGRO
BENIN	ISRAEL	SEYCHELLES
BOLIVIA	ITALY	SIERRA LEONE
BOSNIA AND HERZEGOVINA	JAMAICA	SIINGAPORE
BOTSWANA	JAPAN	SLOVAKIA
BRAZIL	JORDAN	SLOVENIA
BULGARIA	KAZAKHSTAN	SOUTH AFRICA
BURKINA FASO	KENYA	SPAIN
CAMEROON	KOREA, REPUBLIC OF	SRI LANKA
CANADA	KUWAIT	SUDAN
CENTRAL AFRICAN REPUBLIC	KYRGYZSTAN	SWEDEN
CHILE	LATVIA	SWITZERLAND
CHINA	LEBANON	SYRIAN ARAB REPUBLIC
COLOMBIA	LIBERIA	TAJIKISTAN
COSTA RICA	LIBYAN ARAB JAMAHIRIYA	THAILAND
CÔTE D'IVOIRE	LIECHTENSTEIN	THE FORMER YUGOSLAV REPUBLIC OF MACEDONIA
CROATIA	LITHUANIA	TUNISIA
CUBA	LUXEMBOURG	TURKEY
CYPRUS	MADAGASCAR	UGANDA
CZECH REPUBLIC	MALAYSIA	UKRAINE
DEMOCRATIC REPUBLIC OF THE CONGO	MALI	UNITED ARAB EMIRATES
DENMARK	MALTA	UNITED KINGDOM OF GREAT BRITAIN AND NORTHERN IRELAND
DOMINICAN REPUBLIC	MARSHALL ISLANDS	UNITED REPUBLIC OF TANZANIA
ECUADOR	MAURITIUS	UNITED STATES OF AMERICA
EGYPT	MEXICO	URUGUAY
EL SALVADOR	MONACO	UZBEKISTAN
ERITREA	MONGOLIA	VENEZUELA
ESTONIA	MOROCCO	VIETNAM
ETHIOPIA	MYANMAR	YEMEN
FINLAND	NAMIBIA	ZAMBIA
FRANCE	NETHERLANDS	ZIMBABWE
GABON	NEW ZEALAND	
GEORGIA	NICARAGUA	
GERMANY	NIGER	
GHANA	NIGERIA	
	NORWAY	
	PAKISTAN	
	PANAMA	

The Agency's Statute was approved on 23 October 1956 by the Conference on the Statute of the IAEA held at United Nations Headquarters, New York; it entered into force on 29 July 1957. The Headquarters of the Agency are situated in Vienna. Its principal objective is "to accelerate and enlarge the contribution of atomic energy to peace, health and prosperity throughout the world".

© IAEA, 2004

Permission to reproduce or translate the information contained in this publication may be obtained by writing to the International Atomic Energy Agency, Wagramer Strasse 5, P.O. Box 100, A-1400 Vienna, Austria.

Printed by the IAEA in Austria  
July 2004  
STI/PUB/1194

SAFETY STANDARDS SERIES No. TS-R-1

REGULATIONS  
FOR THE SAFE TRANSPORT  
OF RADIOACTIVE MATERIAL

1996 Edition (As Amended 2003)

INTERNATIONAL ATOMIC ENERGY AGENCY  
VIENNA, 2004

THIS SAFETY SERIES PUBLICATION IS ALSO ISSUED IN  
FRENCH, RUSSIAN AND SPANISH

**IAEA Library Cataloguing in Publication Data**

Regulations for the safe transport of radioactive material : 1996 edition (as amended 2003) — Vienna : International Atomic Energy Agency, 2004.

p. ; 24 cm. — (Safety standards series, ISSN 1020-525X ; no. TS-R-1)  
STI/PUB/1194

ISBN 92-0-105704-0

Includes bibliographical references.

1. Radioactive substances — Transportation — Law and legislation.  
I. International Atomic Energy Agency. II. Series.

IAEAL

04-00375

# **FOREWORD**

**by Mohamed ElBaradei  
Director General**

One of the statutory functions of the IAEA is to establish or adopt standards of safety for the protection of health, life and property in the development and application of nuclear energy for peaceful purposes, and to provide for the application of these standards to its own operations as well as to assisted operations and, at the request of the parties, to operations under any bilateral or multilateral arrangement, or, at the request of a State, to any of that State's activities in the field of nuclear energy.

The following bodies oversee the development of safety standards: the Commission for Safety Standards (CSS); the Nuclear Safety Standards Committee (NUSSC); the Radiation Safety Standards Committee (RASSC); the Transport Safety Standards Committee (TRANSSC); and the Waste Safety Standards Committee (WASSC). Member States are widely represented on these committees.

In order to ensure the broadest international consensus, safety standards are also submitted to all Member States for comment before approval by the IAEA Board of Governors (for Safety Fundamentals and Safety Requirements) or, on behalf of the Director General, by the Publications Committee (for Safety Guides).

The IAEA's safety standards are not legally binding on Member States but may be adopted by them, at their own discretion, for use in national regulations in respect of their own activities. The standards are binding on the IAEA in relation to its own operations and on States in relation to operations assisted by the IAEA. Any State wishing to enter into an agreement with the IAEA for its assistance in connection with the siting, design, construction, commissioning, operation or decommissioning of a nuclear facility or any other activities will be required to follow those parts of the safety standards that pertain to the activities to be covered by the agreement. However, it should be recalled that the final decisions and legal responsibilities in any licensing procedures rest with the States.

Although the safety standards establish an essential basis for safety, the incorporation of more detailed requirements, in accordance with national practice, may also be necessary. Moreover, there will generally be special aspects that need to be assessed by experts on a case by case basis.

The physical protection of fissile and radioactive materials and of nuclear power plants as a whole is mentioned where appropriate but is not treated in

detail; obligations of States in this respect should be addressed on the basis of the relevant instruments and publications developed under the auspices of the IAEA.

#### *EDITORIAL NOTE*

*These Regulations generally use the form 'shall' in making statements about requirements, duties and obligations. Use of the form 'should' is restricted to statements that are a desired option. Use of the form 'may' is limited to statements that are pursuant to an option provided by the Regulations. All terms which are defined in Section II are shown throughout the text in italics when used in the defined sense to enhance recognition of these terms.*

*Reference to standards of other organizations is not to be construed as an endorsement on the part of the IAEA.*



## PREFACE

Director General to apply the Regulations to IAEA operations and IAEA assisted operations. The Director General was also authorized to recommend to Member States and international organizations that the Regulations be taken as the basis for corresponding national and international regulations. By 1969, the Regulations had been adopted by almost all international organizations concerned with transport and used by many Member States for their own regulations.

Through the worldwide adoption of the IAEA's Regulations for all modes of transport, a very high standard of safety in transport has been achieved. In the revisions since the first edition, attempts have been made to find a balance between the need to take account of technical advances and operational experience, and the desirability of providing a stable framework of regulatory requirements. One of the aims of this approach is to allow packages designed to previous versions of the Regulations to continue to be used for a reasonable period of time. It is recognized that not all regulatory changes can be implemented simultaneously; Member States and international organizations are therefore invited, in adopting this revision, to provide for use of both the 'old' requirements and the 'new' ones during a period of transition that may last for a few years. It is further recommended that adoption of these revised Regulations occur within a period of five years from publication to achieve worldwide harmonization of their application. In implementing the provisions of these Regulations, it may be necessary for Member States to issue complementary national regulations. Except as necessary for solely domestic purposes, such national regulations should not conflict with these Regulations.

The IAEA has previously published two companion documents to Safety Series No. 6: one entitled 'Advisory Material for the IAEA Regulations for the Safe Transport of Radioactive Material', Safety Series No. 37, and the other entitled 'Explanatory Material for the IAEA Regulations for the Safe Transport of Radioactive Material', Safety Series No. 7. For the benefit of designers and manufacturers of packagings, consignors, carriers, competent authorities and others, Safety Series No. 37 provided advisory information about the technical requirements of the Regulations and about methods and technology that may be employed to fulfil them; the so called 'how' of these provisions. Safety Series No. 7 provided explanatory information on the intent and rationale of the regulatory requirements; the so called 'why' of these provisions. Its purpose was to help comprehension of the regulatory standards, to promote compliance, public acceptance and future development of the Regulations. In support of the 1996 Edition (Revised) of the Regulations, the IAEA published a companion document "Advisory Material for the IAEA Regulations for the Safe Transport of Radioactive Material, IAEA Safety Standards Series No. TSG1" in 2002, that combines both the advisory and explanatory material. Member States

and international organizations concerned are invited to take note of this companion document and to bring it to the notice of persons and organizations affected by these Regulations.

For convenience, the requirements to be met for the transport of specified types of consignments are included in an abbreviated form as Schedules in this publication.

This publication is an amended version of the 1996 Edition of the Transport Regulations. It includes the minor changes and corrigenda incorporated in the 1996 Edition published in 2000 and it further includes amendments arising from the first cycle of a new biennial review and revision process, as agreed by the Transport Safety Standards Committee (TRANSSC) at its 7th meeting in March 2002 and as endorsed by the Committee on Safety Standards at its meeting in June 2002.

# CONTENTS

*(Paragraph numbers are given in parentheses)*

SECTION I. INTRODUCTION .....	1
Background (101–103) .....	1
Objective (104–105) .....	1
Scope (106–109) .....	2
Structure (110) .....	3
SECTION II. DEFINITIONS (201–248) .....	5
SECTION III. GENERAL PROVISIONS .....	15
Radiation protection (301–307) .....	15
Emergency response (308–309) .....	16
Quality assurance (310) .....	16
Compliance assurance (311) .....	17
Special arrangement (312) .....	17
Non-compliance (313) .....	17
Training (314–316) .....	18
SECTION IV. ACTIVITY LIMITS AND MATERIAL RESTRICTIONS ...	21
Basic radionuclide values (401) .....	21
Determination of basic radionuclide values (402–406) .....	21
Contents limits for packages (407–419) .....	40
SECTION V. REQUIREMENTS AND CONTROLS FOR TRANSPORT .....	45
Requirements before the first shipment (501) .....	45
Requirements before each shipment (502) .....	45
Transport of other goods (503–506) .....	46
Other dangerous properties of contents (507) .....	47
Requirements and controls for contamination and for leaking packages (508–514) .....	47
Requirements and controls for transport of excepted packages (515–520) ....	48
Requirements and controls for transport of LSA material and SCO in industrial packages or unpackaged (521–525) .....	50

Determination of transport index (TI) (526–527) .....	51
Determination of criticality safety index (CSI) (528–529) .....	52
Limits on transport index, criticality safety index and radiation levels for packages and overpacks (530–532) .....	53
Categories (533) .....	53
Marking, labelling and placarding (534–547) .....	54
Consignor’s responsibilities (548–561) .....	64
Transport and storage in transit (562–580) .....	68
Customs operations (581) .....	73
Undeliverable consignments (582) .....	74
 SECTION VI. REQUIREMENTS FOR RADIOACTIVE MATERIALS AND FOR PACKAGINGS AND PACKAGES .....	 75
Requirements for radioactive materials (601–605) .....	75
General requirements for all packagings and packages (606–616) .....	76
Additional requirements for packages transported by air (617–619) .....	77
Requirements for excepted packages (620) .....	77
Requirements for industrial packages (621–628) .....	78
Requirements for packages containing uranium hexafluoride (629–632) .....	80
Requirements for Type A packages (633–649) .....	81
Requirements for Type B(U) packages (650–664) .....	83
Requirements for Type B(M) packages (665–666) .....	85
Requirements for Type C packages (667–670) .....	86
Requirements for packages containing fissile material (671–682) .....	87
 SECTION VII. TEST PROCEDURES .....	 93
Demonstration of compliance (701–702) .....	93
Leaching test for LSA–III material and low dispersible radioactive material (703) .....	93
Tests for special form radioactive material (704–711) .....	94
Tests for low dispersible radioactive material (712) .....	96
Tests for packages (713–737) .....	96
 SECTION VIII. APPROVAL AND ADMINISTRATIVE REQUIREMENTS .....	 103
General (801–802) .....	103
Approval of special form radioactive material and low dispersible radioactive material (803–804) .....	103

Approval of package designs (805–814) .....	104
Transitional arrangements (815–818) .....	106
Notification and registration of serial numbers (819) .....	108
Approval of shipments (820–823) .....	108
Approval of shipments under special arrangement (824–826) .....	109
Competent authority approval certificates (827–829) .....	109
Contents of approval certificates (830–833) .....	112
Validation of certificates (834) .....	117
 REFERENCES .....	 119
 SCHEDULES OF REQUIREMENTS FOR THE TRANSPORT OF SPECIFIED TYPES OF RADIOACTIVE MATERIAL CONSIGNMENTS .....	        121
 Common provisions for Schedules 1–4 .....	 123
Schedule 1      Limited quantities of radioactive material in excepted packages .....	127
Schedule 2      Instruments or articles in excepted packages .....	130
Schedule 3      Articles manufactured from natural uranium, depleted uranium or natural thorium as excepted packages .....	133
Schedule 4      Empty packagings as excepted packages .....	135
 Common provisions for Schedules 5–14 .....	 138
Schedule 5      Low specific activity material (LSA–I) .....	147
Schedule 6      Low specific activity material (LSA–II) .....	152
Schedule 7      Low specific activity material (LSA–III) .....	157
Schedule 8      Surface contaminated objects (SCO–I and SCO–II) .....	162
Schedule 9      Material in Type A packages .....	168
Schedule 10     Material in Type B(U) packages .....	173
Schedule 11     Material in Type B(M) packages .....	178
Schedule 12     Material in Type C packages .....	183
Schedule 13     Fissile material .....	187
Schedule 14     Material transported under special arrangement .....	192
 ANNEX I:      Summary of approval and prior notification requirements .....	  198
 ANNEX II:     Conversion factors and prefixes .....	 203

CONTRIBUTORS TO DRAFTING AND REVIEW .....	205
INDEX .....	223

LIST OF TABLES

Table I	Basic radionuclide values .....	22
Table II	Basic radionuclide values for unknown radionuclides or mixtures .....	41
Table III	Activity limits for excepted packages .....	41
Table IV	Industrial package requirements for LSA material and SCO .....	51
Table V	Conveyance activity limits for LSA material and SCO in industrial packages or unpackaged .....	51
Table VI	Multiplication factors for tanks, freight containers, and unpackaged LSA-I and SCO-I .....	52
Table VII	Categories of packages and overpacks .....	54
Table VIII	Excerpts from list of United Nations numbers, proper shipping names and descriptions, subsidiary risks and their relationship to the Schedules .....	55
Table IX	TI limits for freight containers and conveyances not under exclusive use .....	69
Table X	CSI limits for freight containers and conveyances containing fissile material .....	70
Table XI	Insulation data .....	84
Table XII	Consignment mass limits for exceptions from the requirements for packages containing fissile material .....	88
Table XIII	Free drop distance for testing packages to normal conditions of transport .....	98

# Section I

## INTRODUCTION

### BACKGROUND

101. These Regulations establish standards of safety which provide an acceptable level of control of the radiation, criticality and thermal hazards to persons, property and the environment that are associated with the transport of *radioactive material*. These Regulations utilize the principles set forth in both the “Radiation Protection and the Safety of Radiation Sources”, IAEA Safety Series No. 120 [1] and the “International Basic Safety Standards for Protection against Ionizing Radiation and for the Safety of Radiation Sources”, IAEA Safety Series No. 115 [2], jointly sponsored by the Food and Agriculture Organization of the United Nations, the IAEA, the International Labour Organisation, the OECD Nuclear Energy Agency, the Pan American Health Organization and the World Health Organization. Thus, compliance with these Regulations is deemed to satisfy the principles of the Basic Safety Standards in respect of transport.

102. This Safety Standard is supplemented by a hierarchy of Safety Guides and Safety Practices including “Advisory Material for the IAEA Regulations for the Safe Transport of Radioactive Material (1996 Edition)”, IAEA Safety Standards Series No. TS-G-1.1 (ST-2) [3], “Planning and Preparing for Emergency Response to Transport Accidents Involving Radioactive Material”, IAEA Safety Standards Series No. TS-G-1.2 (ST-3) [4], “Compliance Assurance for the Safe Transport of Radioactive Material”, IAEA Safety Standards Series No. TS-G-1.4 [5] and “Quality Assurance for the Safe Transport of Radioactive Material”, IAEA Safety Standards Series No. TS-G-1.3 [6].

103. In certain parts of these Regulations, a particular action is prescribed, but the responsibility for carrying out the action is not specifically assigned to any particular legal person. Such responsibility may vary according to the laws and customs of different countries and the international conventions into which these countries have entered. For the purpose of these Regulations, it is not necessary to make this assignment, but only to identify the action itself. It remains the prerogative of each government to assign this responsibility.

### OBJECTIVE

104. The objective of these Regulations is to protect persons, property and the environment from the effects of radiation during the transport of *radioactive material*.

## SECTION I

This protection is achieved by requiring:

- (a) containment of the *radioactive contents*;
- (b) control of external *radiation levels*;
- (c) prevention of criticality; and
- (d) prevention of damage caused by heat.

These requirements are satisfied firstly by applying a graded approach to contents limits for *packages* and *conveyances* and to performance standards applied to *package designs* depending upon the hazard of the *radioactive contents*. Secondly, they are satisfied by imposing requirements on the *design* and operation of *packages* and on the maintenance of *packagings*, including a consideration of the nature of the *radioactive contents*. Finally, they are satisfied by requiring administrative controls including, where appropriate, *approval by competent authorities*.

105. In the transport of *radioactive material* the safety of persons, who are either members of the public or workers, is assured when these Regulations are complied with. Confidence in this regard is achieved through *quality assurance* and *compliance assurance* programmes.

### SCOPE

106. These Regulations apply to the transport of *radioactive material* by all modes on land, water or in the air, including transport which is incidental to the use of the *radioactive material*. Transport comprises all operations and conditions associated with and involved in the movement of *radioactive material*; these include the design, manufacture, maintenance and repair of *packaging*, and the preparation, consigning, loading, carriage including in-transit storage, unloading and receipt at the final destination of loads of *radioactive material* and *packages*. A graded approach is applied to the performance standards in these Regulations that is characterized by three general severity levels:

- (a) routine conditions of transport (incident free);
- (b) normal conditions of transport (minor mishaps);
- (c) accident conditions of transport.

107. The Regulations do not apply to:

- (a) radioactive material that is an integral part of the means of transport;



## INTRODUCTION

- (b) radioactive material moved within an establishment which is subject to appropriate safety regulations in force in the establishment and where the movement does not involve public roads or railways;
- (c) radioactive material implanted or incorporated into a person or live animal for diagnosis or treatment;
- (d) radioactive material in consumer products which have received regulatory approval, following their sale to the end user;
- (e) natural material and ores containing naturally occurring radionuclides that either are in their natural state, or have been processed only for purposes other than for the extraction of the radionuclides, and that are not intended to be processed for use of these radionuclides, provided that the activity concentration of the material does not exceed 10 times the values specified in paras 401–406;
- (f) non-radioactive solid objects with radioactive substances present on any surfaces in quantities not in excess of the levels defined in para. 214.

108. These Regulations do not specify controls such as routing or physical protection which may be instituted for reasons other than radiological safety. Any such controls shall take into account radiological and non-radiological hazards, and shall not detract from the standards of safety which these Regulations are intended to provide.

109. For *radioactive material* having subsidiary risks, and for transport of *radioactive material* with other dangerous goods, the relevant transport regulations for dangerous goods of each of the countries through or into which the material is to be transported shall apply in addition to these Regulations.

## STRUCTURE

110. This publication is structured so that Section II defines the terms that are required for the purposes of the Regulations; Section III provides general provisions; Section IV provides activity limits and material restrictions used throughout these Regulations; Section V provides requirements and controls for transport; Section VI provides requirements for radioactive material and for packagings and packages; Section VII provides requirements for test procedures; Section VIII provides requirements for approvals and administration. For convenience, the requirements for the transport of specified types of consignments are included in an abbreviated form as Schedules in this publication.

## Section II

### DEFINITIONS

The following definitions shall apply for the purposes of these Regulations

*A<sub>1</sub>* and *A<sub>2</sub>*

201. *A<sub>1</sub>* shall mean the activity value of *special form radioactive material* which is listed in Table I or derived in Section IV and is used to determine the activity limits for the requirements of these Regulations. *A<sub>2</sub>* shall mean the activity value of *radioactive material*, other than *special form radioactive material*, which is listed in Table I or derived in Section IV and is used to determine the activity limits for the requirements of these Regulations.

*Aircraft*

202. *Cargo aircraft* shall mean any aircraft, other than a *passenger aircraft*, which is carrying goods or property.

203. *Passenger aircraft* shall mean an aircraft that carries any person other than a crew member, a *carrier's* employee in an official capacity, an authorized representative of an appropriate national authority, or a person accompanying a *consignment*.

*Approval*

204. *Multilateral approval* shall mean approval by the relevant *competent authority* both of the country of origin of the *design* or *shipment* and of each country through or into which the *consignment* is to be transported. The term "through or into" specifically excludes "over", i.e. the approval and notification requirements shall not apply to a country over which *radioactive material* is carried in an *aircraft*, provided that there is no scheduled stop in that country.

205. *Unilateral approval* shall mean an approval of a *design* which is required to be given by the *competent authority* of the country of origin of the *design* only.

*Carrier*

206. *Carrier* shall mean any person, organization or government undertaking the carriage of *radioactive material* by any means of transport. The term includes both

## SECTION II

carriers for hire or reward (known as common or contract carriers in some countries) and carriers on own account (known as private carriers in some countries).

### *Competent authority*

207. *Competent authority* shall mean any national or international regulatory body or authority designated or otherwise recognized as such for any purpose in connection with these Regulations.

### *Compliance assurance*

208. *Compliance assurance* shall mean a systematic programme of measures applied by a *competent authority* which is aimed at ensuring that the provisions of these Regulations are met in practice.

### *Confinement system*

209. *Confinement system* shall mean the assembly of *fissile material* and *packaging* components specified by the designer and agreed to by the *competent authority* as intended to preserve criticality safety.

### *Consignee*

210. *Consignee* shall mean any person, organization or government which receives a *consignment*.

### *Consignment*

211. *Consignment* shall mean any *package* or *packages*, or load of *radioactive material*, presented by a *consignor* for transport.

### *Consignor*

212. *Consignor* shall mean any person, organization or government which prepares a *consignment* for transport, and is named as *consignor* in the transport documents.

### *Containment system*

213. *Containment system* shall mean the assembly of components of the *packaging* specified by the designer as intended to retain the *radioactive material* during transport.

## DEFINITIONS

### *Contamination*

214. *Contamination* shall mean the presence of a radioactive substance on a surface in quantities in excess of 0.4 Bq/cm<sup>2</sup> for beta and gamma emitters and *low toxicity alpha emitters*, or 0.04 Bq/cm<sup>2</sup> for all other alpha emitters.

215. *Non-fixed contamination* shall mean *contamination* that can be removed from a surface during routine conditions of transport.

216. *Fixed contamination* shall mean *contamination* other than *non-fixed contamination*.

### *Conveyance*

217. *Conveyance* shall mean

- (a) for transport by road or rail: any *vehicle*,
- (b) for transport by water: any *vessel*, or any hold, compartment, or *defined deck area* of a *vessel*, and
- (c) for transport by air: any *aircraft*.

### *Criticality safety index*

218. *Criticality safety index (CSI)* assigned to a *package*, *overpack* or *freight container* containing *fissile material* shall mean a number which is used to provide control over the accumulation of *packages*, *overpacks* or *freight containers* containing *fissile material*.

### *Defined deck area*

219. *Defined deck area* shall mean the area, of the weather deck of a *vessel*, or of a *vehicle deck* of a roll-on/roll-off ship or a ferry, which is allocated for the stowage of *radioactive material*.

### *Design*

220. *Design* shall mean the description of *special form radioactive material*, *low dispersible radioactive material*, *package* or *packaging* which enables such an item to be fully identified. The description may include specifications, engineering drawings, reports demonstrating compliance with regulatory requirements, and other relevant documentation.

## SECTION II

### *Exclusive use*

221. *Exclusive use* shall mean the sole use, by a single *consignor*, of a *conveyance* or of a large *freight container*, in respect of which all initial, intermediate and final loading and unloading is carried out in accordance with the directions of the *consignor* or *consignee*.

### *Fissile material*

222. *Fissile material* shall mean uranium-233, uranium-235, plutonium-239, plutonium-241, or any combination of these radionuclides. Excepted from this definition is:

- (a) *natural uranium* or *depleted uranium* which is unirradiated, and
- (b) *natural uranium* or *depleted uranium* which has been irradiated in thermal reactors only.

### *Freight container*

223. *Freight container* shall mean an article of transport equipment designed to facilitate the transport of goods, either packaged or unpackaged, by one or more modes of transport without intermediate reloading. It shall be of a permanent enclosed character, rigid and strong enough for repeated use, and must be fitted with devices facilitating its handling, particularly in transfer between *conveyances* and from one mode of transport to another. A small *freight container* is that which has either any overall outer dimension less than 1.5 m, or an internal volume of not more than 3 m<sup>3</sup>. Any other *freight container* is considered to be a large *freight container*.

### *Intermediate bulk container*

224. *Intermediate bulk container (IBC)* shall mean a portable *packaging* that:

- (a) has a capacity of not more than 3 m<sup>3</sup>,
- (b) is designed for mechanical handling,
- (c) is resistant to the stresses produced in handling and transport, as determined by performance tests, and
- (d) is designed to conform to the standards in the chapter on Recommendations on Intermediate Bulk Containers (IBC's) of the United Nations Recommendations on the Transport of Dangerous Goods [7].

## DEFINITIONS

### *Low dispersible radioactive material*

225. *Low dispersible radioactive material* shall mean either a solid *radioactive material* or a solid *radioactive material* in a sealed capsule, that has limited dispersibility and is not in powder form.

### *Low specific activity material*

226. *Low specific activity (LSA) material* shall mean *radioactive material* which by its nature has a limited *specific activity*, or *radioactive material* for which limits of estimated average *specific activity* apply. External shielding materials surrounding the *LSA material* shall not be considered in determining the estimated average *specific activity*.

*LSA material* shall be in one of three groups:

#### (a) *LSA-I*

- (i) Uranium and thorium ores and concentrates of such ores, and other ores containing naturally occurring radionuclides which are intended to be processed for the use of these radionuclides;
- (ii) Solid unirradiated *natural uranium* or *depleted uranium* or natural thorium or their solid or liquid compounds or mixtures;
- (iii) *Radioactive material* for which the  $A_2$  value is unlimited, excluding *fissile material* in quantities not excepted under para. 672; or
- (iv) Other *radioactive material* in which the activity is distributed throughout and the estimated average *specific activity* does not exceed 30 times the values for activity concentration specified in paras 401–406, excluding *fissile material* in quantities not excepted under para. 672.

#### (b) *LSA-II*

- (i) Water with tritium concentration up to 0.8 TBq/L; or
- (ii) Other material in which the activity is distributed throughout and the estimated average *specific activity* does not exceed  $10^{-4} A_2/\text{g}$  for solids and gases, and  $10^{-5} A_2/\text{g}$  for liquids.

#### (c) *LSA-III*

Solids (e.g. consolidated wastes, activated materials), excluding powders, in which:

- (i) The *radioactive material* is distributed throughout a solid or a collection of solid objects, or is essentially uniformly distributed in a solid compact binding agent (such as concrete, bitumen, ceramic, etc.);
- (ii) The *radioactive material* is relatively insoluble, or it is intrinsically contained in a relatively insoluble matrix, so that, even under loss of

## SECTION II

- packaging*, the loss of *radioactive material* per *package* by leaching when placed in water for seven days would not exceed  $0.1 A_2$ ; and
- (iii) The estimated average *specific activity* of the solid, excluding any shielding material, does not exceed  $2 \times 10^{-3} A_2/g$ .

### *Low toxicity alpha emitters*

227. *Low toxicity alpha emitters* are: *natural uranium*; *depleted uranium*; natural thorium; uranium-235 or uranium-238; thorium-232; thorium-228 and thorium-230 when contained in ores or physical and chemical concentrates; or alpha emitters with a half-life of less than 10 days.

### *Maximum normal operating pressure*

228. *Maximum normal operating pressure* shall mean the maximum pressure above atmospheric pressure at mean sea-level that would develop in the *containment system* in a period of one year under the conditions of temperature and solar radiation corresponding to environmental conditions in the absence of venting, external cooling by an ancillary system, or operational controls during transport.

### *Overpack*

229. *Overpack* shall mean an enclosure such as a box or bag which is used by a single *consignor* to facilitate as a handling unit a *consignment* of one or more *packages* for convenience of handling, stowage and carriage.

### *Package*

230. *Package* shall mean the *packaging* with its *radioactive contents* as presented for transport. The types of *packages* covered by these Regulations, which are subject to the activity limits and material restrictions of Section IV and meet the corresponding requirements, are:

- (a) *Excepted package*;
- (b) *Industrial package Type 1 (Type IP-1)*;
- (c) *Industrial package Type 2 (Type IP-2)*;
- (d) *Industrial package Type 3 (Type IP-3)*;
- (e) *Type A package*;
- (f) *Type B(U) package*;
- (g) *Type B(M) package*;
- (h) *Type C package*.

## DEFINITIONS

*Packages* containing *fissile material* or uranium hexafluoride are subject to additional requirements.

### *Packaging*

231. *Packaging* shall mean the assembly of components necessary to enclose the *radioactive contents* completely. It may, in particular, consist of one or more receptacles, absorbent materials, spacing structures, radiation shielding and service equipment for filling, emptying, venting and pressure relief; devices for cooling, absorbing mechanical shocks, handling and tie-down, and thermal insulation; and service devices integral to the *package*. The *packaging* may be a box, drum or similar receptacle, or may also be a *freight container, tank* or *intermediate bulk container*.

### *Quality assurance*

232. *Quality assurance* shall mean a systematic programme of controls and inspections applied by any organization or body involved in the transport of *radioactive material* which is aimed at providing adequate confidence that the standard of safety prescribed in these Regulations is achieved in practice.

### *Radiation level*

233. *Radiation level* shall mean the corresponding dose rate expressed in millisieverts per hour.

### *Radiation Protection Programme*

234. *Radiation Protection Programme* shall mean systematic arrangements which are aimed at providing adequate consideration of radiation protection measures.

### *Radioactive contents*

235. *Radioactive contents* shall mean the *radioactive material* together with any contaminated or activated solids, liquids and gases within the *packaging*.

### *Radioactive material*

236. *Radioactive material* shall mean any material containing radionuclides where both the activity concentration and the total activity in the *consignment* exceed the values specified in paras 401–406.



## SECTION II

### *Shipment*

237. *Shipment* shall mean the specific movement of a *consignment* from origin to destination.

### *Special arrangement*

238. *Special arrangement* shall mean those provisions, approved by the *competent authority*, under which *consignments* which do not satisfy all the applicable requirements of these Regulations may be transported.

### *Special form radioactive material*

239. *Special form radioactive material* shall mean either an indispersible solid *radioactive material* or a sealed capsule containing *radioactive material*.

### *Specific activity*

240. *Specific activity* of a radionuclide shall mean the activity per unit mass of that nuclide. The *specific activity* of a material shall mean the activity per unit mass or volume of the material in which the radionuclides are essentially uniformly distributed.

### *Surface contaminated object*

241. *Surface contaminated object (SCO)* shall mean a solid object which is not itself radioactive but which has *radioactive material* distributed on its surfaces. *SCO* shall be in one of two groups:

- (a) *SCO-I*: A solid object on which:
- (i) the *non-fixed contamination* on the accessible surface averaged over 300 cm<sup>2</sup> (or the area of the surface if less than 300 cm<sup>2</sup>) does not exceed 4 Bq/cm<sup>2</sup> for beta and gamma emitters and *low toxicity alpha emitters*, or 0.4 Bq/cm<sup>2</sup> for all other alpha emitters; and
  - (ii) the *fixed contamination* on the accessible surface averaged over 300 cm<sup>2</sup> (or the area of the surface if less than 300 cm<sup>2</sup>) does not exceed  $4 \times 10^4$  Bq/cm<sup>2</sup> for beta and gamma emitters and *low toxicity alpha emitters*, or  $4 \times 10^3$  Bq/cm<sup>2</sup> for all other alpha emitters; and
  - (iii) the *non-fixed contamination* plus the *fixed contamination* on the inaccessible surface averaged over 300 cm<sup>2</sup> (or the area of the surface if less than 300 cm<sup>2</sup>) does not exceed  $4 \times 10^4$  Bq/cm<sup>2</sup> for beta and gamma

## DEFINITIONS

- emitters and *low toxicity alpha emitters*, or  $4 \times 10^3$  Bq/cm<sup>2</sup> for all other alpha emitters.
- (b) *SCO-II*: A solid object on which either the *fixed* or *non-fixed contamination* on the surface exceeds the applicable limits specified for *SCO-I* in (a) above and on which:
- (i) the *non-fixed contamination* on the accessible surface averaged over 300 cm<sup>2</sup> (or the area of the surface if less than 300 cm<sup>2</sup>) does not exceed 400 Bq/cm<sup>2</sup> for beta and gamma emitters and *low toxicity alpha emitters*, or 40 Bq/cm<sup>2</sup> for all other alpha emitters; and
  - (ii) the *fixed contamination* on the accessible surface, averaged over 300 cm<sup>2</sup> (or the area of the surface if less than 300 cm<sup>2</sup>) does not exceed  $8 \times 10^5$  Bq/cm<sup>2</sup> for beta and gamma emitters and *low toxicity alpha emitters*, or  $8 \times 10^4$  Bq/cm<sup>2</sup> for all other alpha emitters; and
  - (iii) the *non-fixed contamination* plus the *fixed contamination* on the inaccessible surface averaged over 300 cm<sup>2</sup> (or the area of the surface if less than 300 cm<sup>2</sup>) does not exceed  $8 \times 10^5$  Bq/cm<sup>2</sup> for beta and gamma emitters and *low toxicity alpha emitters*, or  $8 \times 10^4$  Bq/cm<sup>2</sup> for all other alpha emitters.

### *Tank*

242. *Tank* shall mean a tank container, a portable tank, a road tank vehicle, a rail tank wagon or a receptacle with a capacity of not less than 450 litres to contain liquids, powders, granules, slurries or solids which are loaded as gas or liquid and subsequently solidified, and of not less than 1000 litres to contain gases. A tank container shall be capable of being carried on land or on sea and of being loaded and discharged without the need of removal of its structural equipment, shall possess stabilizing members and tie-down attachments external to the shell, and shall be capable of being lifted when full.

### *Transport index*

243. *Transport index (TI)* assigned to a *package*, *overpack* or *freight container*, or to unpackaged *LSA-I* or *SCO-I*, shall mean a number which is used to provide control over radiation exposure.

### *Unirradiated thorium*

244. *Unirradiated thorium* shall mean thorium containing not more than  $10^{-7}$  g of uranium-233 per gram of thorium-232.

## SECTION II

### *Unirradiated uranium*

245. *Unirradiated uranium* shall mean uranium containing not more than  $2 \times 10^3$  Bq of plutonium per gram of uranium-235, not more than  $9 \times 10^6$  Bq of fission products per gram of uranium-235 and not more than  $5 \times 10^{-3}$  g of uranium-236 per gram of uranium-235.

### *Uranium — natural, depleted, enriched*

246. *Natural uranium* shall mean chemically separated uranium containing the naturally occurring distribution of uranium isotopes (approximately 99.28% uranium-238, and 0.72% uranium-235 by mass). *Depleted uranium* shall mean uranium containing a lesser mass percentage of uranium-235 than in *natural uranium*. *Enriched uranium* shall mean uranium containing a greater mass percentage of uranium-235 than 0.72%. In all cases, a very small mass percentage of uranium-234 is present.

### *Vehicle*

247. *Vehicle* shall mean a road vehicle (including an articulated vehicle, i.e. a tractor and semi-trailer combination) or railroad car or railway wagon. Each trailer shall be considered as a separate *vehicle*.

### *Vessel*

248. *Vessel* shall mean any seagoing vessel or inland waterway craft used for carrying cargo.

## Section III

### GENERAL PROVISIONS

#### RADIATION PROTECTION

301. A *Radiation Protection Programme* shall be established for the transport of *radioactive material*. The nature and extent of the measures to be employed in the programme shall be related to the magnitude and likelihood of radiation exposures. The programme shall incorporate the requirements of paras 302–303 and 305–309. Programme documents shall be available, on request, for inspection by the relevant *competent authority*.

302. In transport, protection and safety shall be optimized in order that the magnitude of individual doses, the number of persons exposed, and the likelihood of incurring exposure shall be kept as low as reasonably achievable, economic and social factors being taken into account, and doses to persons shall be below the relevant dose limits. A structured and systematic approach shall be adopted and shall include consideration of the interfaces between transport and other activities.

303. Workers shall receive appropriate training concerning the radiation hazards involved and the precautions to be observed in order to ensure restriction of their exposure and that of other persons who might be affected by their actions.

304. The relevant *competent authority* shall arrange for periodic assessments of the radiation doses to persons due to the transport of *radioactive material*, to ensure that the system of protection and safety complies with the Basic Safety Standards [2].

305. For occupational exposures arising from transport activities, where it is assessed that the effective dose:

- (a) is most unlikely to exceed 1 mSv in a year, neither special work patterns nor detailed monitoring nor dose assessment programmes nor individual record keeping shall be required;
- (b) is likely to be between 1 and 6 mSv in a year, a dose assessment programme via work place monitoring or individual monitoring shall be conducted;
- (c) is likely to exceed 6 mSv in a year, individual monitoring shall be conducted.

When individual monitoring or work place monitoring is conducted, appropriate records shall be kept.

### SECTION III

306. *Radioactive material* shall be segregated sufficiently from workers and from members of the public. The following values for dose shall be used for the purpose of calculating segregation distances or *radiation levels*:

- (a) for workers in regularly occupied working areas a dose of 5 mSv in a year;
- (b) for members of the public, in areas where the public has regular access, a dose of 1 mSv in a year to the critical group, with account taken of exposures expected to be delivered by all other relevant sources and practices under control.

307. *Radioactive material* shall be sufficiently segregated from undeveloped photographic film. The basis for determining segregation distances for this purpose shall be that the radiation exposure of undeveloped photographic film due to the transport of *radioactive material* be limited to 0.1 mSv per *consignment* of such film.

#### EMERGENCY RESPONSE

308. In the event of accidents or incidents during the transport of *radioactive material*, emergency provisions, as established by relevant national and/or international organizations, shall be observed to protect persons, property and the environment. Appropriate guidelines for such provisions are contained in Ref. [4].

309. Emergency procedures shall take into account the formation of other dangerous substances that may result from the reaction between the contents of a *consignment* and the environment in the event of an accident.

#### QUALITY ASSURANCE

310. *Quality assurance* programmes based on international, national or other standards acceptable to the *competent authority* shall be established and implemented for the design, manufacture, testing, documentation, use, maintenance and inspection of all *special form radioactive material*, *low dispersible radioactive material* and *packages* and for transport and in-transit storage operations to ensure compliance with the relevant provisions of these Regulations. Certification that the *design* specification has been fully implemented shall be available to the *competent authority*. The manufacturer, *consignor* or user shall be prepared to provide facilities for *competent authority* inspection during manufacture and use and to demonstrate to any cognizant *competent authority* that:

- (a) the manufacturing methods and materials used are in accordance with the approved *design* specifications; and

## GENERAL PROVISIONS

- (b) all *packagings* are periodically inspected and, as necessary, repaired and maintained in good condition so that they continue to comply with all relevant requirements and specifications, even after repeated use.

Where *competent authority approval* is required, such *approval* shall take into account and be contingent upon the adequacy of the *quality assurance* programme.

## COMPLIANCE ASSURANCE

311. The *competent authority* is responsible for assuring compliance with these Regulations. Means to discharge this responsibility include the establishment and execution of a programme for monitoring the design, manufacture, testing, inspection and maintenance of *packaging, special form radioactive material and low dispersible radioactive material*, and the preparation, documentation, handling and stowage of *packages* by *consignors* and *carriers*, to provide evidence that the provisions of these Regulations are being met in practice.

## SPECIAL ARRANGEMENT

312. *Consignments* for which conformity with the other provisions of these Regulations is impracticable shall not be transported except under *special arrangement*. Provided the *competent authority* is satisfied that conformity with the other provisions of these Regulations is impracticable and that the requisite standards of safety established by these Regulations have been demonstrated through means alternative to the other provisions, the *competent authority* may approve *special arrangement* transport operations for single or a planned series of multiple *consignments*. The overall level of safety in transport shall be at least equivalent to that which would be provided if all the applicable requirements had been met. For international *consignments* of this type, *multilateral approval* shall be required.

## NON-COMPLIANCE

313. In the event of non-compliance with any limit in these Regulations applicable to *radiation level* or *contamination*:

- (a) the *consignor* shall be informed of the non-compliance by:
  - (i) the *carrier* if the non-compliance is identified during transport; or
  - (ii) the *consignee* if the non-compliance is identified at receipt;
- (b) the *carrier, consignor* or *consignee*, as appropriate shall:
  - (i) take immediate steps to mitigate the consequences of the non-compliance;

### SECTION III

- (ii) investigate the non-compliance and its causes, circumstances and consequences;
  - (iii) take appropriate action to remedy the causes and circumstances that led to the non-compliance and to prevent a recurrence of circumstances similar to those that led to the non-compliance;
  - (iv) communicate to the relevant *competent authority(ies)* on the causes of the non-compliance and on corrective or preventive actions taken or to be taken; and
- (c) the communication of the non-compliance to the *consignor* and relevant *competent authority(ies)*, respectively, shall be made as soon as practicable and it shall be immediate whenever an emergency exposure situation has developed or is developing.

#### TRAINING

314. Persons engaged in the transport of *radioactive material* shall receive training in the contents of these Regulations commensurate with their responsibilities.

315. Individuals such as those who classify *radioactive material*; pack *radioactive material*; mark and label *radioactive material*; prepare transport documents for *radioactive material*; offer or accept *radioactive material* for transport; carry or handle *radioactive material* in transport; mark or placard or load or unload packages of *radioactive material* into or from transport *vehicles*, bulk *packagings* or *freight containers*; or are otherwise directly involved in the transport of *radioactive material* as determined by the *competent authority*; shall receive the following training:

- (a) General awareness/familiarization training:
  - (i) Each person shall receive training designed to provide familiarity with the general provisions of these Regulations;
  - (ii) Such training shall include a description of the categories of *radioactive material*; labelling, marking, placarding and *packaging* and segregation requirements; a description of the purpose and content of the *radioactive material* transport document; and a description of available emergency response documents;
- (b) Function specific training: Each person shall receive detailed training concerning specific *radioactive material* transport requirements which are applicable to the function that person performs;
- (c) Safety training: Commensurate with the risk of exposure in the event of a release and the functions performed, each person shall receive training on:

## GENERAL PROVISIONS

- (i) Methods and procedures for accident avoidance, such as proper use of package handling equipment and appropriate methods of stowage of *radioactive material*;
- (ii) Available emergency response information and how to use it;
- (iii) General dangers presented by the various categories of *radioactive material* and how to prevent exposure to those hazards, including if appropriate the use of personal protective clothing and equipment; and
- (iv) Immediate procedures to be followed in the event of an unintentional release of *radioactive material*, including any emergency response procedures for which the person is responsible and personal protection procedures to be followed.

316. The training required in para. 315 shall be provided or verified upon employment in a position involving *radioactive material* transport and shall be periodically supplemented with retraining as deemed appropriate by the *competent authority*.



## Section IV

### ACTIVITY LIMITS AND MATERIAL RESTRICTIONS

#### BASIC RADIONUCLIDE VALUES

401. The following basic values for individual radionuclides are given in Table I:

- (a)  $A_1$  and  $A_2$  in TBq;
- (b) activity concentration for exempt material in Bq/g; and
- (c) activity limits for exempt consignments in Bq.

#### DETERMINATION OF BASIC RADIONUCLIDE VALUES

402. For individual radionuclides which are not listed in Table I the determination of the basic radionuclide values referred to in para. 401 shall require *competent authority* approval or, for international transport, *multilateral approval*. Where the chemical form of each radionuclide is known, it is permissible to use the  $A_2$  value related to its solubility class as recommended by the International Commission on Radiological Protection, if the chemical forms under both normal and accident conditions of transport are taken into consideration. Alternatively, the radionuclide values in Table II may be used without obtaining *competent authority* approval.

403. In the calculations of  $A_1$  and  $A_2$  for a radionuclide not in Table I, a single radioactive decay chain in which the radionuclides are present in their naturally occurring proportions, and in which no daughter nuclide has a half-life either longer than 10 days or longer than that of the parent nuclide, shall be considered as a single radionuclide; and the activity to be taken into account and the  $A_1$  or  $A_2$  value to be applied shall be those corresponding to the parent nuclide of that chain. In the case of radioactive decay chains in which any daughter nuclide has a half-life either longer than 10 days or greater than that of the parent nuclide, the parent and such daughter nuclides shall be considered as mixtures of different nuclides.

404. For mixtures of radionuclides, the determination of the basic radionuclide values referred to in para. 401 may be determined as follows:

$$X_m = \frac{1}{\sum_i \frac{f(i)}{X(i)}}$$

*Text continued on page 40*

## SECTION IV

TABLE I. BASIC RADIONUCLIDE VALUES

Radionuclide (atomic number)	$A_1$	$A_2$	Activity concentration for exempt material	Activity limit for an exempt consignment
	(TBq)	(TBq)	(Bq/g)	(Bq)
Actinium (89)				
Ac-225 (a)	$8 \times 10^{-1}$	$6 \times 10^{-3}$	$1 \times 10^1$	$1 \times 10^4$
Ac-227 (a)	$9 \times 10^{-1}$	$9 \times 10^{-5}$	$1 \times 10^{-1}$	$1 \times 10^3$
Ac-228	$6 \times 10^{-1}$	$5 \times 10^{-1}$	$1 \times 10^1$	$1 \times 10^6$
Silver (47)				
Ag-105	$2 \times 10^0$	$2 \times 10^0$	$1 \times 10^2$	$1 \times 10^6$
Ag-108m (a)	$7 \times 10^{-1}$	$7 \times 10^{-1}$	$1 \times 10^1$ (b)	$1 \times 10^6$ (b)
Ag-110m (a)	$4 \times 10^{-1}$	$4 \times 10^{-1}$	$1 \times 10^1$	$1 \times 10^6$
Ag-111	$2 \times 10^0$	$6 \times 10^{-1}$	$1 \times 10^3$	$1 \times 10^6$
Aluminium (13)				
Al-26	$1 \times 10^{-1}$	$1 \times 10^{-1}$	$1 \times 10^1$	$1 \times 10^5$
Americium (95)				
Am-241	$1 \times 10^1$	$1 \times 10^{-3}$	$1 \times 10^0$	$1 \times 10^4$
Am-242m (a)	$1 \times 10^1$	$1 \times 10^{-3}$	$1 \times 10^0$ (b)	$1 \times 10^4$ (b)
Am-243 (a)	$5 \times 10^0$	$1 \times 10^{-3}$	$1 \times 10^0$ (b)	$1 \times 10^3$ (b)
Argon (18)				
Ar-37	$4 \times 10^1$	$4 \times 10^1$	$1 \times 10^6$	$1 \times 10^8$
Ar-39	$4 \times 10^1$	$2 \times 10^1$	$1 \times 10^7$	$1 \times 10^4$
Ar-41	$3 \times 10^{-1}$	$3 \times 10^{-1}$	$1 \times 10^2$	$1 \times 10^9$
Arsenic (33)				
As-72	$3 \times 10^{-1}$	$3 \times 10^{-1}$	$1 \times 10^1$	$1 \times 10^5$
As-73	$4 \times 10^1$	$4 \times 10^1$	$1 \times 10^3$	$1 \times 10^7$
As-74	$1 \times 10^0$	$9 \times 10^{-1}$	$1 \times 10^1$	$1 \times 10^6$
As-76	$3 \times 10^{-1}$	$3 \times 10^{-1}$	$1 \times 10^2$	$1 \times 10^5$
As-77	$2 \times 10^1$	$7 \times 10^{-1}$	$1 \times 10^3$	$1 \times 10^6$
Astatine (85)				
At-211 (a)	$2 \times 10^1$	$5 \times 10^{-1}$	$1 \times 10^3$	$1 \times 10^7$
Gold (79)				
Au-193	$7 \times 10^0$	$2 \times 10^0$	$1 \times 10^2$	$1 \times 10^7$

For footnotes see pages 38 and 39.

ACTIVITY LIMITS AND MATERIAL RESTRICTIONS

TABLE I. (cont.)

Radionuclide (atomic number)	$A_1$	$A_2$	Activity concentration for exempt material	Activity limit for an exempt consignment
	(TBq)	(TBq)	(Bq/g)	(Bq)
Au-194	$1 \times 10^0$	$1 \times 10^0$	$1 \times 10^1$	$1 \times 10^6$
Au-195	$1 \times 10^1$	$6 \times 10^0$	$1 \times 10^2$	$1 \times 10^7$
Au-198	$1 \times 10^0$	$6 \times 10^{-1}$	$1 \times 10^2$	$1 \times 10^6$
Au-199	$1 \times 10^1$	$6 \times 10^{-1}$	$1 \times 10^2$	$1 \times 10^6$
Barium (56)				
Ba-131 (a)	$2 \times 10^0$	$2 \times 10^0$	$1 \times 10^2$	$1 \times 10^6$
Ba-133	$3 \times 10^0$	$3 \times 10^0$	$1 \times 10^2$	$1 \times 10^6$
Ba-133m	$2 \times 10^1$	$6 \times 10^{-1}$	$1 \times 10^2$	$1 \times 10^6$
Ba-140 (a)	$5 \times 10^{-1}$	$3 \times 10^{-1}$	$1 \times 10^1$ (b)	$1 \times 10^5$ (b)
Beryllium (4)				
Be-7	$2 \times 10^1$	$2 \times 10^1$	$1 \times 10^3$	$1 \times 10^7$
Be-10	$4 \times 10^1$	$6 \times 10^{-1}$	$1 \times 10^4$	$1 \times 10^6$
Bismuth (83)				
Bi-205	$7 \times 10^{-1}$	$7 \times 10^{-1}$	$1 \times 10^1$	$1 \times 10^6$
Bi-206	$3 \times 10^{-1}$	$3 \times 10^{-1}$	$1 \times 10^1$	$1 \times 10^5$
Bi-207	$7 \times 10^{-1}$	$7 \times 10^{-1}$	$1 \times 10^1$	$1 \times 10^6$
Bi-210	$1 \times 10^0$	$6 \times 10^{-1}$	$1 \times 10^3$	$1 \times 10^6$
Bi-210m (a)	$6 \times 10^{-1}$	$2 \times 10^{-2}$	$1 \times 10^1$	$1 \times 10^5$
Bi-212 (a)	$7 \times 10^{-1}$	$6 \times 10^{-1}$	$1 \times 10^1$ (b)	$1 \times 10^5$ (b)
Berkelium (97)				
Bk-247	$8 \times 10^0$	$8 \times 10^{-4}$	$1 \times 10^0$	$1 \times 10^4$
Bk-249 (a)	$4 \times 10^1$	$3 \times 10^{-1}$	$1 \times 10^3$	$1 \times 10^6$
Bromine (35)				
Br-76	$4 \times 10^{-1}$	$4 \times 10^{-1}$	$1 \times 10^1$	$1 \times 10^5$
Br-77	$3 \times 10^0$	$3 \times 10^0$	$1 \times 10^2$	$1 \times 10^6$
Br-82	$4 \times 10^{-1}$	$4 \times 10^{-1}$	$1 \times 10^1$	$1 \times 10^6$
Carbon (6)				
C-11	$1 \times 10^0$	$6 \times 10^{-1}$	$1 \times 10^1$	$1 \times 10^6$
C-14	$4 \times 10^1$	$3 \times 10^0$	$1 \times 10^4$	$1 \times 10^7$

For footnotes see pages 38 and 39.

## SECTION IV

TABLE I. (cont.)

Radionuclide (atomic number)	$A_1$	$A_2$	Activity concentration for exempt material	Activity limit for an exempt consignment
	(TBq)	(TBq)	(Bq/g)	(Bq)
Calcium (20)				
Ca-41	Unlimited	Unlimited	$1 \times 10^5$	$1 \times 10^7$
Ca-45	$4 \times 10^1$	$1 \times 10^0$	$1 \times 10^4$	$1 \times 10^7$
Ca-47 (a)	$3 \times 10^0$	$3 \times 10^{-1}$	$1 \times 10^1$	$1 \times 10^6$
Cadmium (48)				
Cd-109	$3 \times 10^1$	$2 \times 10^0$	$1 \times 10^4$	$1 \times 10^6$
Cd-113m	$4 \times 10^1$	$5 \times 10^{-1}$	$1 \times 10^3$	$1 \times 10^6$
Cd-115 (a)	$3 \times 10^0$	$4 \times 10^{-1}$	$1 \times 10^2$	$1 \times 10^6$
Cd-115m	$5 \times 10^{-1}$	$5 \times 10^{-1}$	$1 \times 10^3$	$1 \times 10^6$
Cerium (58)				
Ce-139	$7 \times 10^0$	$2 \times 10^0$	$1 \times 10^2$	$1 \times 10^6$
Ce-141	$2 \times 10^1$	$6 \times 10^{-1}$	$1 \times 10^2$	$1 \times 10^7$
Ce-143	$9 \times 10^{-1}$	$6 \times 10^{-1}$	$1 \times 10^2$	$1 \times 10^6$
Ce-144 (a)	$2 \times 10^{-1}$	$2 \times 10^{-1}$	$1 \times 10^2$ (b)	$1 \times 10^5$ (b)
Californium (98)				
Cf-248	$4 \times 10^1$	$6 \times 10^{-3}$	$1 \times 10^1$	$1 \times 10^4$
Cf-249	$3 \times 10^0$	$8 \times 10^{-4}$	$1 \times 10^0$	$1 \times 10^3$
Cf-250	$2 \times 10^1$	$2 \times 10^{-3}$	$1 \times 10^1$	$1 \times 10^4$
Cf-251	$7 \times 10^0$	$7 \times 10^{-4}$	$1 \times 10^0$	$1 \times 10^3$
Cf-252	$1 \times 10^{-1}$	$3 \times 10^{-3}$	$1 \times 10^1$	$1 \times 10^4$
Cf-253 (a)	$4 \times 10^1$	$4 \times 10^{-2}$	$1 \times 10^2$	$1 \times 10^5$
Cf-254	$1 \times 10^{-3}$	$1 \times 10^{-3}$	$1 \times 10^0$	$1 \times 10^3$
Chlorine (17)				
Cl-36	$1 \times 10^1$	$6 \times 10^{-1}$	$1 \times 10^4$	$1 \times 10^6$
Cl-38	$2 \times 10^{-1}$	$2 \times 10^{-1}$	$1 \times 10^1$	$1 \times 10^5$
Curium (96)				
Cm-240	$4 \times 10^1$	$2 \times 10^{-2}$	$1 \times 10^2$	$1 \times 10^5$
Cm-241	$2 \times 10^0$	$1 \times 10^0$	$1 \times 10^2$	$1 \times 10^6$
Cm-242	$4 \times 10^1$	$1 \times 10^{-2}$	$1 \times 10^2$	$1 \times 10^5$

For footnotes see pages 38 and 39.

ACTIVITY LIMITS AND MATERIAL RESTRICTIONS

TABLE I. (cont.)

Radionuclide (atomic number)	$A_1$	$A_2$	Activity concentration for exempt material	Activity limit for an exempt consignment
	(TBq)	(TBq)	(Bq/g)	(Bq)
Cm-243	$9 \times 10^0$	$1 \times 10^{-3}$	$1 \times 10^0$	$1 \times 10^4$
Cm-244	$2 \times 10^1$	$2 \times 10^{-3}$	$1 \times 10^1$	$1 \times 10^4$
Cm-245	$9 \times 10^0$	$9 \times 10^{-4}$	$1 \times 10^0$	$1 \times 10^3$
Cm-246	$9 \times 10^0$	$9 \times 10^{-4}$	$1 \times 10^0$	$1 \times 10^3$
Cm-247 (a)	$3 \times 10^0$	$1 \times 10^{-3}$	$1 \times 10^0$	$1 \times 10^4$
Cm-248	$2 \times 10^{-2}$	$3 \times 10^{-4}$	$1 \times 10^0$	$1 \times 10^3$
Cobalt (27)				
Co-55	$5 \times 10^{-1}$	$5 \times 10^{-1}$	$1 \times 10^1$	$1 \times 10^6$
Co-56	$3 \times 10^{-1}$	$3 \times 10^{-1}$	$1 \times 10^1$	$1 \times 10^5$
Co-57	$1 \times 10^1$	$1 \times 10^1$	$1 \times 10^2$	$1 \times 10^6$
Co-58	$1 \times 10^0$	$1 \times 10^0$	$1 \times 10^1$	$1 \times 10^6$
Co-58m	$4 \times 10^1$	$4 \times 10^1$	$1 \times 10^4$	$1 \times 10^7$
Co-60	$4 \times 10^{-1}$	$4 \times 10^{-1}$	$1 \times 10^1$	$1 \times 10^5$
Chromium (24)				
Cr-51	$3 \times 10^1$	$3 \times 10^1$	$1 \times 10^3$	$1 \times 10^7$
Caesium (55)				
Cs-129	$4 \times 10^0$	$4 \times 10^0$	$1 \times 10^2$	$1 \times 10^5$
Cs-131	$3 \times 10^1$	$3 \times 10^1$	$1 \times 10^3$	$1 \times 10^6$
Cs-132	$1 \times 10^0$	$1 \times 10^0$	$1 \times 10^1$	$1 \times 10^5$
Cs-134	$7 \times 10^{-1}$	$7 \times 10^{-1}$	$1 \times 10^1$	$1 \times 10^4$
Cs-134m	$4 \times 10^1$	$6 \times 10^{-1}$	$1 \times 10^3$	$1 \times 10^5$
Cs-135	$4 \times 10^1$	$1 \times 10^0$	$1 \times 10^4$	$1 \times 10^7$
Cs-136	$5 \times 10^{-1}$	$5 \times 10^{-1}$	$1 \times 10^1$	$1 \times 10^5$
Cs-137 (a)	$2 \times 10^0$	$6 \times 10^{-1}$	$1 \times 10^1$ (b)	$1 \times 10^4$ (b)
Copper (29)				
Cu-64	$6 \times 10^0$	$1 \times 10^0$	$1 \times 10^2$	$1 \times 10^6$
Cu-67	$1 \times 10^1$	$7 \times 10^{-1}$	$1 \times 10^2$	$1 \times 10^6$
Dysprosium (66)				
Dy-159	$2 \times 10^1$	$2 \times 10^1$	$1 \times 10^3$	$1 \times 10^7$

For footnotes see pages 38 and 39.

## SECTION IV

TABLE I. (cont.)

Radionuclide (atomic number)	$A_1$	$A_2$	Activity concentration for exempt material	Activity limit for an exempt consignment
	(TBq)	(TBq)	(Bq/g)	(Bq)
Dy-165	$9 \times 10^{-1}$	$6 \times 10^{-1}$	$1 \times 10^3$	$1 \times 10^6$
Dy-166 (a)	$9 \times 10^{-1}$	$3 \times 10^{-1}$	$1 \times 10^3$	$1 \times 10^6$
Erbium (68)				
Er-169	$4 \times 10^1$	$1 \times 10^0$	$1 \times 10^4$	$1 \times 10^7$
Er-171	$8 \times 10^{-1}$	$5 \times 10^{-1}$	$1 \times 10^2$	$1 \times 10^6$
Europium (63)				
Eu-147	$2 \times 10^0$	$2 \times 10^0$	$1 \times 10^2$	$1 \times 10^6$
Eu-148	$5 \times 10^{-1}$	$5 \times 10^{-1}$	$1 \times 10^1$	$1 \times 10^6$
Eu-149	$2 \times 10^1$	$2 \times 10^1$	$1 \times 10^2$	$1 \times 10^7$
Eu-150 (short lived)	$2 \times 10^0$	$7 \times 10^{-1}$	$1 \times 10^3$	$1 \times 10^6$
Eu-150 (long lived)	$7 \times 10^{-1}$	$7 \times 10^{-1}$	$1 \times 10^1$	$1 \times 10^6$
Eu-152	$1 \times 10^0$	$1 \times 10^0$	$1 \times 10^1$	$1 \times 10^6$
Eu-152m	$8 \times 10^{-1}$	$8 \times 10^{-1}$	$1 \times 10^2$	$1 \times 10^6$
Eu-154	$9 \times 10^{-1}$	$6 \times 10^{-1}$	$1 \times 10^1$	$1 \times 10^6$
Eu-155	$2 \times 10^1$	$3 \times 10^0$	$1 \times 10^2$	$1 \times 10^7$
Eu-156	$7 \times 10^{-1}$	$7 \times 10^{-1}$	$1 \times 10^1$	$1 \times 10^6$
Fluorine (9)				
F-18	$1 \times 10^0$	$6 \times 10^{-1}$	$1 \times 10^1$	$1 \times 10^6$
Iron (26)				
Fe-52 (a)	$3 \times 10^{-1}$	$3 \times 10^{-1}$	$1 \times 10^1$	$1 \times 10^6$
Fe-55	$4 \times 10^1$	$4 \times 10^1$	$1 \times 10^4$	$1 \times 10^6$
Fe-59	$9 \times 10^{-1}$	$9 \times 10^{-1}$	$1 \times 10^1$	$1 \times 10^6$
Fe-60 (a)	$4 \times 10^1$	$2 \times 10^{-1}$	$1 \times 10^2$	$1 \times 10^5$
Gallium (31)				
Ga-67	$7 \times 10^0$	$3 \times 10^0$	$1 \times 10^2$	$1 \times 10^6$
Ga-68	$5 \times 10^{-1}$	$5 \times 10^{-1}$	$1 \times 10^1$	$1 \times 10^5$
Ga-72	$4 \times 10^{-1}$	$4 \times 10^{-1}$	$1 \times 10^1$	$1 \times 10^5$
Gadolinium (64)				
Gd-146 (a)	$5 \times 10^{-1}$	$5 \times 10^{-1}$	$1 \times 10^1$	$1 \times 10^6$

For footnotes see pages 38 and 39.

ACTIVITY LIMITS AND MATERIAL RESTRICTIONS

TABLE I. (cont.)

Radionuclide (atomic number)	$A_1$	$A_2$	Activity concentration for exempt material	Activity limit for an exempt consignment
	(TBq)	(TBq)	(Bq/g)	(Bq)
Gd-148	$2 \times 10^1$	$2 \times 10^{-3}$	$1 \times 10^1$	$1 \times 10^4$
Gd-153	$1 \times 10^1$	$9 \times 10^0$	$1 \times 10^2$	$1 \times 10^7$
Gd-159	$3 \times 10^0$	$6 \times 10^{-1}$	$1 \times 10^3$	$1 \times 10^6$
Germanium (32)				
Ge-68 (a)	$5 \times 10^{-1}$	$5 \times 10^{-1}$	$1 \times 10^1$	$1 \times 10^5$
Ge-71	$4 \times 10^1$	$4 \times 10^1$	$1 \times 10^4$	$1 \times 10^8$
Ge-77	$3 \times 10^{-1}$	$3 \times 10^{-1}$	$1 \times 10^1$	$1 \times 10^5$
Hafnium (72)				
Hf-172 (a)	$6 \times 10^{-1}$	$6 \times 10^{-1}$	$1 \times 10^1$	$1 \times 10^6$
Hf-175	$3 \times 10^0$	$3 \times 10^0$	$1 \times 10^2$	$1 \times 10^6$
Hf-181	$2 \times 10^0$	$5 \times 10^{-1}$	$1 \times 10^1$	$1 \times 10^6$
Hf-182	Unlimited	Unlimited	$1 \times 10^2$	$1 \times 10^6$
Mercury (80)				
Hg-194 (a)	$1 \times 10^0$	$1 \times 10^0$	$1 \times 10^1$	$1 \times 10^6$
Hg-195m (a)	$3 \times 10^0$	$7 \times 10^{-1}$	$1 \times 10^2$	$1 \times 10^6$
Hg-197	$2 \times 10^1$	$1 \times 10^1$	$1 \times 10^2$	$1 \times 10^7$
Hg-197m	$1 \times 10^1$	$4 \times 10^{-1}$	$1 \times 10^2$	$1 \times 10^6$
Hg-203	$5 \times 10^0$	$1 \times 10^0$	$1 \times 10^2$	$1 \times 10^5$
Holmium (67)				
Ho-166	$4 \times 10^{-1}$	$4 \times 10^{-1}$	$1 \times 10^3$	$1 \times 10^5$
Ho-166m	$6 \times 10^{-1}$	$5 \times 10^{-1}$	$1 \times 10^1$	$1 \times 10^6$
Iodine (53)				
I-123	$6 \times 10^0$	$3 \times 10^0$	$1 \times 10^2$	$1 \times 10^7$
I-124	$1 \times 10^0$	$1 \times 10^0$	$1 \times 10^1$	$1 \times 10^6$
I-125	$2 \times 10^1$	$3 \times 10^0$	$1 \times 10^3$	$1 \times 10^6$
I-126	$2 \times 10^0$	$1 \times 10^0$	$1 \times 10^2$	$1 \times 10^6$
I-129	Unlimited	Unlimited	$1 \times 10^2$	$1 \times 10^5$
I-131	$3 \times 10^0$	$7 \times 10^{-1}$	$1 \times 10^2$	$1 \times 10^6$
I-132	$4 \times 10^{-1}$	$4 \times 10^{-1}$	$1 \times 10^1$	$1 \times 10^5$

For footnotes see pages 38 and 39.

## SECTION IV

TABLE I. (cont.)

Radionuclide (atomic number)	$A_1$	$A_2$	Activity concentration for exempt material	Activity limit for an exempt consignment
	(TBq)	(TBq)	(Bq/g)	(Bq)
I-133	$7 \times 10^{-1}$	$6 \times 10^{-1}$	$1 \times 10^1$	$1 \times 10^6$
I-134	$3 \times 10^{-1}$	$3 \times 10^{-1}$	$1 \times 10^1$	$1 \times 10^5$
I-135 (a)	$6 \times 10^{-1}$	$6 \times 10^{-1}$	$1 \times 10^1$	$1 \times 10^6$
Indium (49)				
In-111	$3 \times 10^0$	$3 \times 10^0$	$1 \times 10^2$	$1 \times 10^6$
In-113m	$4 \times 10^0$	$2 \times 10^0$	$1 \times 10^2$	$1 \times 10^6$
In-114m (a)	$1 \times 10^1$	$5 \times 10^{-1}$	$1 \times 10^2$	$1 \times 10^6$
In-115m	$7 \times 10^0$	$1 \times 10^0$	$1 \times 10^2$	$1 \times 10^6$
Iridium (77)				
Ir-189 (a)	$1 \times 10^1$	$1 \times 10^1$	$1 \times 10^2$	$1 \times 10^7$
Ir-190	$7 \times 10^{-1}$	$7 \times 10^{-1}$	$1 \times 10^1$	$1 \times 10^6$
Ir-192	$1 \times 10^0$ (c)	$6 \times 10^{-1}$	$1 \times 10^1$	$1 \times 10^4$
Ir-194	$3 \times 10^{-1}$	$3 \times 10^{-1}$	$1 \times 10^2$	$1 \times 10^5$
Potassium (19)				
K-40	$9 \times 10^{-1}$	$9 \times 10^{-1}$	$1 \times 10^2$	$1 \times 10^6$
K-42	$2 \times 10^{-1}$	$2 \times 10^{-1}$	$1 \times 10^2$	$1 \times 10^6$
K-43	$7 \times 10^{-1}$	$6 \times 10^{-1}$	$1 \times 10^1$	$1 \times 10^6$
Krypton (36)				
Kr-81	$4 \times 10^1$	$4 \times 10^1$	$1 \times 10^4$	$1 \times 10^7$
Kr-85	$1 \times 10^1$	$1 \times 10^1$	$1 \times 10^5$	$1 \times 10^4$
Kr-85m	$8 \times 10^0$	$3 \times 10^0$	$1 \times 10^3$	$1 \times 10^{10}$
Kr-87	$2 \times 10^{-1}$	$2 \times 10^{-1}$	$1 \times 10^2$	$1 \times 10^9$
Lanthanum (57)				
La-137	$3 \times 10^1$	$6 \times 10^0$	$1 \times 10^3$	$1 \times 10^7$
La-140	$4 \times 10^{-1}$	$4 \times 10^{-1}$	$1 \times 10^1$	$1 \times 10^5$
Lutetium (71)				
Lu-172	$6 \times 10^{-1}$	$6 \times 10^{-1}$	$1 \times 10^1$	$1 \times 10^6$
Lu-173	$8 \times 10^0$	$8 \times 10^0$	$1 \times 10^2$	$1 \times 10^7$
Lu-174	$9 \times 10^0$	$9 \times 10^0$	$1 \times 10^2$	$1 \times 10^7$

For footnotes see pages 38 and 39.



ACTIVITY LIMITS AND MATERIAL RESTRICTIONS

TABLE I. (cont.)

Radionuclide (atomic number)	$A_1$	$A_2$	Activity concentration for exempt material	Activity limit for an exempt consignment
	(TBq)	(TBq)	(Bq/g)	(Bq)
Lu-174m	$2 \times 10^1$	$1 \times 10^1$	$1 \times 10^2$	$1 \times 10^7$
Lu-177	$3 \times 10^1$	$7 \times 10^{-1}$	$1 \times 10^3$	$1 \times 10^7$
Magnesium (12)				
Mg-28 (a)	$3 \times 10^{-1}$	$3 \times 10^{-1}$	$1 \times 10^1$	$1 \times 10^5$
Manganese (25)				
Mn-52	$3 \times 10^{-1}$	$3 \times 10^{-1}$	$1 \times 10^1$	$1 \times 10^5$
Mn-53	Unlimited	Unlimited	$1 \times 10^4$	$1 \times 10^9$
Mn-54	$1 \times 10^0$	$1 \times 10^0$	$1 \times 10^1$	$1 \times 10^6$
Mn-56	$3 \times 10^{-1}$	$3 \times 10^{-1}$	$1 \times 10^1$	$1 \times 10^5$
Molybdenum (42)				
Mo-93	$4 \times 10^1$	$2 \times 10^1$	$1 \times 10^3$	$1 \times 10^8$
Mo-99 (a)	$1 \times 10^0$	$6 \times 10^{-1}$	$1 \times 10^2$	$1 \times 10^6$
Nitrogen (7)				
N-13	$9 \times 10^{-1}$	$6 \times 10^{-1}$	$1 \times 10^2$	$1 \times 10^9$
Sodium (11)				
Na-22	$5 \times 10^{-1}$	$5 \times 10^{-1}$	$1 \times 10^1$	$1 \times 10^6$
Na-24	$2 \times 10^{-1}$	$2 \times 10^{-1}$	$1 \times 10^1$	$1 \times 10^5$
Niobium (41)				
Nb-93m	$4 \times 10^1$	$3 \times 10^1$	$1 \times 10^4$	$1 \times 10^7$
Nb-94	$7 \times 10^{-1}$	$7 \times 10^{-1}$	$1 \times 10^1$	$1 \times 10^6$
Nb-95	$1 \times 10^0$	$1 \times 10^0$	$1 \times 10^1$	$1 \times 10^6$
Nb-97	$9 \times 10^{-1}$	$6 \times 10^{-1}$	$1 \times 10^1$	$1 \times 10^6$
Neodymium (60)				
Nd-147	$6 \times 10^0$	$6 \times 10^{-1}$	$1 \times 10^2$	$1 \times 10^6$
Nd-149	$6 \times 10^{-1}$	$5 \times 10^{-1}$	$1 \times 10^2$	$1 \times 10^6$
Nickel (28)				
Ni-59	Unlimited	Unlimited	$1 \times 10^4$	$1 \times 10^8$
Ni-63	$4 \times 10^1$	$3 \times 10^1$	$1 \times 10^5$	$1 \times 10^8$
Ni-65	$4 \times 10^{-1}$	$4 \times 10^{-1}$	$1 \times 10^1$	$1 \times 10^6$

For footnotes see pages 38 and 39.

## SECTION IV

TABLE I. (cont.)

Radionuclide (atomic number)	$A_1$	$A_2$	Activity concentration for exempt material	Activity limit for an exempt consignment
	(TBq)	(TBq)	(Bq/g)	(Bq)
Neptunium (93)				
Np-235	$4 \times 10^1$	$4 \times 10^1$	$1 \times 10^3$	$1 \times 10^7$
Np-236 (short lived)	$2 \times 10^1$	$2 \times 10^0$	$1 \times 10^3$	$1 \times 10^7$
Np-236 (long lived)	$9 \times 10^0$	$2 \times 10^{-2}$	$1 \times 10^2$	$1 \times 10^5$
Np-237	$2 \times 10^1$	$2 \times 10^{-3}$	$1 \times 10^0$ (b)	$1 \times 10^3$ (b)
Np-239	$7 \times 10^0$	$4 \times 10^{-1}$	$1 \times 10^2$	$1 \times 10^7$
Osmium (76)				
Os-185	$1 \times 10^0$	$1 \times 10^0$	$1 \times 10^1$	$1 \times 10^6$
Os-191	$1 \times 10^1$	$2 \times 10^0$	$1 \times 10^2$	$1 \times 10^7$
Os-191m	$4 \times 10^1$	$3 \times 10^1$	$1 \times 10^3$	$1 \times 10^7$
Os-193	$2 \times 10^0$	$6 \times 10^{-1}$	$1 \times 10^2$	$1 \times 10^6$
Os-194 (a)	$3 \times 10^{-1}$	$3 \times 10^{-1}$	$1 \times 10^2$	$1 \times 10^5$
Phosphorus (15)				
P-32	$5 \times 10^{-1}$	$5 \times 10^{-1}$	$1 \times 10^3$	$1 \times 10^5$
P-33	$4 \times 10^1$	$1 \times 10^0$	$1 \times 10^5$	$1 \times 10^8$
Protactinium (91)				
Pa-230 (a)	$2 \times 10^0$	$7 \times 10^{-2}$	$1 \times 10^1$	$1 \times 10^6$
Pa-231	$4 \times 10^0$	$4 \times 10^{-4}$	$1 \times 10^0$	$1 \times 10^3$
Pa-233	$5 \times 10^0$	$7 \times 10^{-1}$	$1 \times 10^2$	$1 \times 10^7$
Lead (82)				
Pb-201	$1 \times 10^0$	$1 \times 10^0$	$1 \times 10^1$	$1 \times 10^6$
Pb-202	$4 \times 10^1$	$2 \times 10^1$	$1 \times 10^3$	$1 \times 10^6$
Pb-203	$4 \times 10^0$	$3 \times 10^0$	$1 \times 10^2$	$1 \times 10^6$
Pb-205	Unlimited	Unlimited	$1 \times 10^4$	$1 \times 10^7$
Pb-210 (a)	$1 \times 10^0$	$5 \times 10^{-2}$	$1 \times 10^1$ (b)	$1 \times 10^4$ (b)
Pb-212 (a)	$7 \times 10^{-1}$	$2 \times 10^{-1}$	$1 \times 10^1$ (b)	$1 \times 10^5$ (b)
Palladium (46)				
Pd-103 (a)	$4 \times 10^1$	$4 \times 10^1$	$1 \times 10^3$	$1 \times 10^8$
Pd-107	Unlimited	Unlimited	$1 \times 10^5$	$1 \times 10^8$

For footnotes see pages 38 and 39.

ACTIVITY LIMITS AND MATERIAL RESTRICTIONS

TABLE I. (cont.)

Radionuclide (atomic number)	$A_1$	$A_2$	Activity concentration for exempt material	Activity limit for an exempt consignment
	(TBq)	(TBq)	(Bq/g)	(Bq)
Pd-109	$2 \times 10^0$	$5 \times 10^{-1}$	$1 \times 10^3$	$1 \times 10^6$
Promethium (61)				
Pm-143	$3 \times 10^0$	$3 \times 10^0$	$1 \times 10^2$	$1 \times 10^6$
Pm-144	$7 \times 10^{-1}$	$7 \times 10^{-1}$	$1 \times 10^1$	$1 \times 10^6$
Pm-145	$3 \times 10^1$	$1 \times 10^1$	$1 \times 10^3$	$1 \times 10^7$
Pm-147	$4 \times 10^1$	$2 \times 10^0$	$1 \times 10^4$	$1 \times 10^7$
Pm-148m (a)	$8 \times 10^{-1}$	$7 \times 10^{-1}$	$1 \times 10^1$	$1 \times 10^6$
Pm-149	$2 \times 10^0$	$6 \times 10^{-1}$	$1 \times 10^3$	$1 \times 10^6$
Pm-151	$2 \times 10^0$	$6 \times 10^{-1}$	$1 \times 10^2$	$1 \times 10^6$
Polonium (84)				
Po-210	$4 \times 10^1$	$2 \times 10^{-2}$	$1 \times 10^1$	$1 \times 10^4$
Praseodymium (59)				
Pr-142	$4 \times 10^{-1}$	$4 \times 10^{-1}$	$1 \times 10^2$	$1 \times 10^5$
Pr-143	$3 \times 10^0$	$6 \times 10^{-1}$	$1 \times 10^4$	$1 \times 10^6$
Platinum (78)				
Pt-188 (a)	$1 \times 10^0$	$8 \times 10^{-1}$	$1 \times 10^1$	$1 \times 10^6$
Pt-191	$4 \times 10^0$	$3 \times 10^0$	$1 \times 10^2$	$1 \times 10^6$
Pt-193	$4 \times 10^1$	$4 \times 10^1$	$1 \times 10^4$	$1 \times 10^7$
Pt-193m	$4 \times 10^1$	$5 \times 10^{-1}$	$1 \times 10^3$	$1 \times 10^7$
Pt-195m	$1 \times 10^1$	$5 \times 10^{-1}$	$1 \times 10^2$	$1 \times 10^6$
Pt-197	$2 \times 10^1$	$6 \times 10^{-1}$	$1 \times 10^3$	$1 \times 10^6$
Pt-197m	$1 \times 10^1$	$6 \times 10^{-1}$	$1 \times 10^2$	$1 \times 10^6$
Plutonium (94)				
Pu-236	$3 \times 10^1$	$3 \times 10^{-3}$	$1 \times 10^1$	$1 \times 10^4$
Pu-237	$2 \times 10^1$	$2 \times 10^1$	$1 \times 10^3$	$1 \times 10^7$
Pu-238	$1 \times 10^1$	$1 \times 10^{-3}$	$1 \times 10^0$	$1 \times 10^4$
Pu-239	$1 \times 10^1$	$1 \times 10^{-3}$	$1 \times 10^0$	$1 \times 10^4$
Pu-240	$1 \times 10^1$	$1 \times 10^{-3}$	$1 \times 10^0$	$1 \times 10^3$
Pu-241 (a)	$4 \times 10^1$	$6 \times 10^{-2}$	$1 \times 10^2$	$1 \times 10^5$

For footnotes see pages 38 and 39.

## SECTION IV

TABLE I. (cont.)

Radionuclide (atomic number)	$A_1$	$A_2$	Activity concentration for exempt material	Activity limit for an exempt consignment
	(TBq)	(TBq)	(Bq/g)	(Bq)
Pu-242	$1 \times 10^1$	$1 \times 10^{-3}$	$1 \times 10^0$	$1 \times 10^4$
Pu-244 (a)	$4 \times 10^{-1}$	$1 \times 10^{-3}$	$1 \times 10^0$	$1 \times 10^4$
Radium (88)				
Ra-223 (a)	$4 \times 10^{-1}$	$7 \times 10^{-3}$	$1 \times 10^2$ (b)	$1 \times 10^5$ (b)
Ra-224 (a)	$4 \times 10^{-1}$	$2 \times 10^{-2}$	$1 \times 10^1$ (b)	$1 \times 10^5$ (b)
Ra-225 (a)	$2 \times 10^{-1}$	$4 \times 10^{-3}$	$1 \times 10^2$	$1 \times 10^5$
Ra-226 (a)	$2 \times 10^{-1}$	$3 \times 10^{-3}$	$1 \times 10^1$ (b)	$1 \times 10^4$ (b)
Ra-228 (a)	$6 \times 10^{-1}$	$2 \times 10^{-2}$	$1 \times 10^1$ (b)	$1 \times 10^5$ (b)
Rubidium (37)				
Rb-81	$2 \times 10^0$	$8 \times 10^{-1}$	$1 \times 10^1$	$1 \times 10^6$
Rb-83 (a)	$2 \times 10^0$	$2 \times 10^0$	$1 \times 10^2$	$1 \times 10^6$
Rb-84	$1 \times 10^0$	$1 \times 10^0$	$1 \times 10^1$	$1 \times 10^6$
Rb-86	$5 \times 10^{-1}$	$5 \times 10^{-1}$	$1 \times 10^2$	$1 \times 10^5$
Rb-87	Unlimited	Unlimited	$1 \times 10^4$	$1 \times 10^7$
Rb (nat)	Unlimited	Unlimited	$1 \times 10^4$	$1 \times 10^7$
Rhenium (75)				
Re-184	$1 \times 10^0$	$1 \times 10^0$	$1 \times 10^1$	$1 \times 10^6$
Re-184m	$3 \times 10^0$	$1 \times 10^0$	$1 \times 10^2$	$1 \times 10^6$
Re-186	$2 \times 10^0$	$6 \times 10^{-1}$	$1 \times 10^3$	$1 \times 10^6$
Re-187	Unlimited	Unlimited	$1 \times 10^6$	$1 \times 10^9$
Re-188	$4 \times 10^{-1}$	$4 \times 10^{-1}$	$1 \times 10^2$	$1 \times 10^5$
Re-189 (a)	$3 \times 10^0$	$6 \times 10^{-1}$	$1 \times 10^2$	$1 \times 10^6$
Re (nat)	Unlimited	Unlimited	$1 \times 10^6$	$1 \times 10^9$
Rhodium (45)				
Rh-99	$2 \times 10^0$	$2 \times 10^0$	$1 \times 10^1$	$1 \times 10^6$
Rh-101	$4 \times 10^0$	$3 \times 10^0$	$1 \times 10^2$	$1 \times 10^7$
Rh-102	$5 \times 10^{-1}$	$5 \times 10^{-1}$	$1 \times 10^1$	$1 \times 10^6$
Rh-102m	$2 \times 10^0$	$2 \times 10^0$	$1 \times 10^2$	$1 \times 10^6$
Rh-103m	$4 \times 10^1$	$4 \times 10^1$	$1 \times 10^4$	$1 \times 10^8$

For footnotes see pages 38 and 39.

ACTIVITY LIMITS AND MATERIAL RESTRICTIONS

TABLE I. (cont.)

Radionuclide (atomic number)	$A_1$	$A_2$	Activity concentration for exempt material	Activity limit for an exempt consignment
	(TBq)	(TBq)	(Bq/g)	(Bq)
Rh-105	$1 \times 10^1$	$8 \times 10^{-1}$	$1 \times 10^2$	$1 \times 10^7$
Radon (86)				
Rn-222 (a)	$3 \times 10^{-1}$	$4 \times 10^{-3}$	$1 \times 10^1$ (b)	$1 \times 10^8$ (b)
Ruthenium (44)				
Ru-97	$5 \times 10^0$	$5 \times 10^0$	$1 \times 10^2$	$1 \times 10^7$
Ru-103 (a)	$2 \times 10^0$	$2 \times 10^0$	$1 \times 10^2$	$1 \times 10^6$
Ru-105	$1 \times 10^0$	$6 \times 10^{-1}$	$1 \times 10^1$	$1 \times 10^6$
Ru-106 (a)	$2 \times 10^{-1}$	$2 \times 10^{-1}$	$1 \times 10^2$ (b)	$1 \times 10^5$ (b)
Sulphur (16)				
S-35	$4 \times 10^1$	$3 \times 10^0$	$1 \times 10^5$	$1 \times 10^8$
Antimony (51)				
Sb-122	$4 \times 10^{-1}$	$4 \times 10^{-1}$	$1 \times 10^2$	$1 \times 10^4$
Sb-124	$6 \times 10^{-1}$	$6 \times 10^{-1}$	$1 \times 10^1$	$1 \times 10^6$
Sb-125	$2 \times 10^0$	$1 \times 10^0$	$1 \times 10^2$	$1 \times 10^6$
Sb-126	$4 \times 10^{-1}$	$4 \times 10^{-1}$	$1 \times 10^1$	$1 \times 10^5$
Scandium (21)				
Sc-44	$5 \times 10^{-1}$	$5 \times 10^{-1}$	$1 \times 10^1$	$1 \times 10^5$
Sc-46	$5 \times 10^{-1}$	$5 \times 10^{-1}$	$1 \times 10^1$	$1 \times 10^6$
Sc-47	$1 \times 10^1$	$7 \times 10^{-1}$	$1 \times 10^2$	$1 \times 10^6$
Sc-48	$3 \times 10^{-1}$	$3 \times 10^{-1}$	$1 \times 10^1$	$1 \times 10^5$
Selenium (34)				
Se-75	$3 \times 10^0$	$3 \times 10^0$	$1 \times 10^2$	$1 \times 10^6$
Se-79	$4 \times 10^1$	$2 \times 10^0$	$1 \times 10^4$	$1 \times 10^7$
Silicon (14)				
Si-31	$6 \times 10^{-1}$	$6 \times 10^{-1}$	$1 \times 10^3$	$1 \times 10^6$
Si-32	$4 \times 10^1$	$5 \times 10^{-1}$	$1 \times 10^3$	$1 \times 10^6$
Samarium (62)				
Sm-145	$1 \times 10^1$	$1 \times 10^1$	$1 \times 10^2$	$1 \times 10^7$
Sm-147	Unlimited	Unlimited	$1 \times 10^1$	$1 \times 10^4$

For footnotes see pages 38 and 39.

## SECTION IV

TABLE I. (cont.)

Radionuclide (atomic number)	$A_1$	$A_2$	Activity concentration for exempt material	Activity limit for an exempt consignment
	(TBq)	(TBq)	(Bq/g)	(Bq)
Sm-151	$4 \times 10^1$	$1 \times 10^1$	$1 \times 10^4$	$1 \times 10^8$
Sm-153	$9 \times 10^0$	$6 \times 10^{-1}$	$1 \times 10^2$	$1 \times 10^6$
Tin (50)				
Sn-113 (a)	$4 \times 10^0$	$2 \times 10^0$	$1 \times 10^3$	$1 \times 10^7$
Sn-117m	$7 \times 10^0$	$4 \times 10^{-1}$	$1 \times 10^2$	$1 \times 10^6$
Sn-119m	$4 \times 10^1$	$3 \times 10^1$	$1 \times 10^3$	$1 \times 10^7$
Sn-121m (a)	$4 \times 10^1$	$9 \times 10^{-1}$	$1 \times 10^3$	$1 \times 10^7$
Sn-123	$8 \times 10^{-1}$	$6 \times 10^{-1}$	$1 \times 10^3$	$1 \times 10^6$
Sn-125	$4 \times 10^{-1}$	$4 \times 10^{-1}$	$1 \times 10^2$	$1 \times 10^5$
Sn-126 (a)	$6 \times 10^{-1}$	$4 \times 10^{-1}$	$1 \times 10^1$	$1 \times 10^5$
Strontium (38)				
Sr-82 (a)	$2 \times 10^{-1}$	$2 \times 10^{-1}$	$1 \times 10^1$	$1 \times 10^5$
Sr-85	$2 \times 10^0$	$2 \times 10^0$	$1 \times 10^2$	$1 \times 10^6$
Sr-85m	$5 \times 10^0$	$5 \times 10^0$	$1 \times 10^2$	$1 \times 10^7$
Sr-87m	$3 \times 10^0$	$3 \times 10^0$	$1 \times 10^2$	$1 \times 10^6$
Sr-89	$6 \times 10^{-1}$	$6 \times 10^{-1}$	$1 \times 10^3$	$1 \times 10^6$
Sr-90 (a)	$3 \times 10^{-1}$	$3 \times 10^{-1}$	$1 \times 10^2$ (b)	$1 \times 10^4$ (b)
Sr-91 (a)	$3 \times 10^{-1}$	$3 \times 10^{-1}$	$1 \times 10^1$	$1 \times 10^5$
Sr-92 (a)	$1 \times 10^0$	$3 \times 10^{-1}$	$1 \times 10^1$	$1 \times 10^6$
Tritium (1)				
T(H-3)	$4 \times 10^1$	$4 \times 10^1$	$1 \times 10^6$	$1 \times 10^9$
Tantalum (73)				
Ta-178 (long lived)	$1 \times 10^0$	$8 \times 10^{-1}$	$1 \times 10^1$	$1 \times 10^6$
Ta-179	$3 \times 10^1$	$3 \times 10^1$	$1 \times 10^3$	$1 \times 10^7$
Ta-182	$9 \times 10^{-1}$	$5 \times 10^{-1}$	$1 \times 10^1$	$1 \times 10^4$
Terbium (65)				
Tb-157	$4 \times 10^1$	$4 \times 10^1$	$1 \times 10^4$	$1 \times 10^7$
Tb-158	$1 \times 10^0$	$1 \times 10^0$	$1 \times 10^1$	$1 \times 10^6$
Tb-160	$1 \times 10^0$	$6 \times 10^{-1}$	$1 \times 10^1$	$1 \times 10^6$

For footnotes see pages 38 and 39.

ACTIVITY LIMITS AND MATERIAL RESTRICTIONS

TABLE I. (cont.)

Radionuclide (atomic number)	$A_1$	$A_2$	Activity concentration for exempt material	Activity limit for an exempt consignment
	(TBq)	(TBq)	(Bq/g)	(Bq)
Technetium (43)				
Tc-95m (a)	$2 \times 10^0$	$2 \times 10^0$	$1 \times 10^1$	$1 \times 10^6$
Tc-96	$4 \times 10^{-1}$	$4 \times 10^{-1}$	$1 \times 10^1$	$1 \times 10^6$
Tc-96m (a)	$4 \times 10^{-1}$	$4 \times 10^{-1}$	$1 \times 10^3$	$1 \times 10^7$
Tc-97	Unlimited	Unlimited	$1 \times 10^3$	$1 \times 10^8$
Tc-97m	$4 \times 10^1$	$1 \times 10^0$	$1 \times 10^3$	$1 \times 10^7$
Tc-98	$8 \times 10^{-1}$	$7 \times 10^{-1}$	$1 \times 10^1$	$1 \times 10^6$
Tc-99	$4 \times 10^1$	$9 \times 10^{-1}$	$1 \times 10^4$	$1 \times 10^7$
Tc-99m	$1 \times 10^1$	$4 \times 10^0$	$1 \times 10^2$	$1 \times 10^7$
Tellurium (52)				
Te-121	$2 \times 10^0$	$2 \times 10^0$	$1 \times 10^1$	$1 \times 10^6$
Te-121m	$5 \times 10^0$	$3 \times 10^0$	$1 \times 10^2$	$1 \times 10^5$
Te-123m	$8 \times 10^0$	$1 \times 10^0$	$1 \times 10^2$	$1 \times 10^7$
Te-125m	$2 \times 10^1$	$9 \times 10^{-1}$	$1 \times 10^3$	$1 \times 10^7$
Te-127	$2 \times 10^1$	$7 \times 10^{-1}$	$1 \times 10^3$	$1 \times 10^6$
Te-127m (a)	$2 \times 10^1$	$5 \times 10^{-1}$	$1 \times 10^3$	$1 \times 10^7$
Te-129	$7 \times 10^{-1}$	$6 \times 10^{-1}$	$1 \times 10^2$	$1 \times 10^6$
Te-129m (a)	$8 \times 10^{-1}$	$4 \times 10^{-1}$	$1 \times 10^3$	$1 \times 10^6$
Te-131m (a)	$7 \times 10^{-1}$	$5 \times 10^{-1}$	$1 \times 10^1$	$1 \times 10^6$
Te-132 (a)	$5 \times 10^{-1}$	$4 \times 10^{-1}$	$1 \times 10^2$	$1 \times 10^7$
Thorium (90)				
Th-227	$1 \times 10^1$	$5 \times 10^{-3}$	$1 \times 10^1$	$1 \times 10^4$
Th-228 (a)	$5 \times 10^{-1}$	$1 \times 10^{-3}$	$1 \times 10^0$ (b)	$1 \times 10^4$ (b)
Th-229	$5 \times 10^0$	$5 \times 10^{-4}$	$1 \times 10^0$ (b)	$1 \times 10^3$ (b)
Th-230	$1 \times 10^1$	$1 \times 10^{-3}$	$1 \times 10^0$	$1 \times 10^4$
Th-231	$4 \times 10^1$	$2 \times 10^{-2}$	$1 \times 10^3$	$1 \times 10^7$
Th-232	Unlimited	Unlimited	$1 \times 10^1$	$1 \times 10^4$
Th-234 (a)	$3 \times 10^{-1}$	$3 \times 10^{-1}$	$1 \times 10^3$ (b)	$1 \times 10^5$ (b)
Th (nat)	Unlimited	Unlimited	$1 \times 10^0$ (b)	$1 \times 10^3$ (b)

For footnotes see pages 38 and 39.

## SECTION IV

TABLE I. (cont.)

Radionuclide (atomic number)	$A_1$	$A_2$	Activity concentration for exempt material	Activity limit for an exempt consignment
	(TBq)	(TBq)	(Bq/g)	(Bq)
Titanium (22)				
Ti-44 (a)	$5 \times 10^{-1}$	$4 \times 10^{-1}$	$1 \times 10^1$	$1 \times 10^5$
Thallium (81)				
Tl-200	$9 \times 10^{-1}$	$9 \times 10^{-1}$	$1 \times 10^1$	$1 \times 10^6$
Tl-201	$1 \times 10^1$	$4 \times 10^0$	$1 \times 10^2$	$1 \times 10^6$
Tl-202	$2 \times 10^0$	$2 \times 10^0$	$1 \times 10^2$	$1 \times 10^6$
Tl-204	$1 \times 10^1$	$7 \times 10^{-1}$	$1 \times 10^4$	$1 \times 10^4$
Thulium (69)				
Tm-167	$7 \times 10^0$	$8 \times 10^{-1}$	$1 \times 10^2$	$1 \times 10^6$
Tm-170	$3 \times 10^0$	$6 \times 10^{-1}$	$1 \times 10^3$	$1 \times 10^6$
Tm-171	$4 \times 10^1$	$4 \times 10^1$	$1 \times 10^4$	$1 \times 10^8$
Uranium (92)				
U-230 (fast lung absorption) (a)(d)	$4 \times 10^1$	$1 \times 10^{-1}$	$1 \times 10^1$ (b)	$1 \times 10^5$ (b)
U-230 (medium lung absorption)(a)(e)	$4 \times 10^1$	$4 \times 10^{-3}$	$1 \times 10^1$	$1 \times 10^4$
U-230 (slow lung absorption) (a)(f)	$3 \times 10^1$	$3 \times 10^{-3}$	$1 \times 10^1$	$1 \times 10^4$
U-232 (fast lung absorption)(d)	$4 \times 10^1$	$1 \times 10^{-2}$	$1 \times 10^0$ (b)	$1 \times 10^3$ (b)
U-232 (medium lung absorption)(e)	$4 \times 10^1$	$7 \times 10^{-3}$	$1 \times 10^1$	$1 \times 10^4$
U-232 (slow lung absorption)(f)	$1 \times 10^1$	$1 \times 10^{-3}$	$1 \times 10^1$	$1 \times 10^4$
U-233 (fast lung absorption)(d)	$4 \times 10^1$	$9 \times 10^{-2}$	$1 \times 10^1$	$1 \times 10^4$
U-233 (medium lung absorption)(e)	$4 \times 10^1$	$2 \times 10^{-2}$	$1 \times 10^2$	$1 \times 10^5$
U-233 (slow lung absorption)(f)	$4 \times 10^1$	$6 \times 10^{-3}$	$1 \times 10^1$	$1 \times 10^5$
U-234 (fast lung absorption)(d)	$4 \times 10^1$	$9 \times 10^{-2}$	$1 \times 10^1$	$1 \times 10^4$
U-234 (medium lung absorption)(e)	$4 \times 10^1$	$2 \times 10^{-2}$	$1 \times 10^2$	$1 \times 10^5$

-----  
For footnotes see pages 38 and 39.



ACTIVITY LIMITS AND MATERIAL RESTRICTIONS

TABLE I. (cont.)

Radionuclide (atomic number)	$A_1$	$A_2$	Activity concentration for exempt material	Activity limit for an exempt consignment
	(TBq)	(TBq)	(Bq/g)	(Bq)
U-234 (slow lung absorption)(f)	$4 \times 10^1$	$6 \times 10^{-3}$	$1 \times 10^1$	$1 \times 10^5$
U-235 (all lung absorption types)(a),(d),(e),(f)	Unlimited	Unlimited	$1 \times 10^1$ (b)	$1 \times 10^4$ (b)
U-236 (fast lung absorption)(d)	Unlimited	Unlimited	$1 \times 10^1$	$1 \times 10^4$
U-236 (medium lung absorption)(e)	$4 \times 10^1$	$2 \times 10^{-2}$	$1 \times 10^2$	$1 \times 10^5$
U-236 (slow lung absorption)(f)	$4 \times 10^1$	$6 \times 10^{-3}$	$1 \times 10^1$	$1 \times 10^4$
U-238 (all lung absorption types)(d),(e),(f)	Unlimited	Unlimited	$1 \times 10^1$ (b)	$1 \times 10^4$ (b)
U (nat)	Unlimited	Unlimited	$1 \times 10^0$ (b)	$1 \times 10^3$ (b)
U (enriched to 20% or less)(g)	Unlimited	Unlimited	$1 \times 10^0$	$1 \times 10^3$
U (dep)	Unlimited	Unlimited	$1 \times 10^0$	$1 \times 10^3$
Vanadium (23)				
V-48	$4 \times 10^{-1}$	$4 \times 10^{-1}$	$1 \times 10^1$	$1 \times 10^5$
V-49	$4 \times 10^1$	$4 \times 10^1$	$1 \times 10^4$	$1 \times 10^7$
Tungsten (74)				
W-178 (a)	$9 \times 10^0$	$5 \times 10^0$	$1 \times 10^1$	$1 \times 10^6$
W-181	$3 \times 10^1$	$3 \times 10^1$	$1 \times 10^3$	$1 \times 10^7$
W-185	$4 \times 10^1$	$8 \times 10^{-1}$	$1 \times 10^4$	$1 \times 10^7$
W-187	$2 \times 10^0$	$6 \times 10^{-1}$	$1 \times 10^2$	$1 \times 10^6$
W-188 (a)	$4 \times 10^{-1}$	$3 \times 10^{-1}$	$1 \times 10^2$	$1 \times 10^5$
Xenon (54)				
Xe-122 (a)	$4 \times 10^{-1}$	$4 \times 10^{-1}$	$1 \times 10^2$	$1 \times 10^9$
Xe-123	$2 \times 10^0$	$7 \times 10^{-1}$	$1 \times 10^2$	$1 \times 10^9$
Xe-127	$4 \times 10^0$	$2 \times 10^0$	$1 \times 10^3$	$1 \times 10^5$
Xe-131m	$4 \times 10^1$	$4 \times 10^1$	$1 \times 10^4$	$1 \times 10^4$

For footnotes see pages 38 and 39.

## SECTION IV

TABLE I. (cont.)

Radionuclide (atomic number)	$A_1$	$A_2$	Activity concentration for exempt material	Activity limit for an exempt consignment
	(TBq)	(TBq)	(Bq/g)	(Bq)
Xe-133	$2 \times 10^1$	$1 \times 10^1$	$1 \times 10^3$	$1 \times 10^4$
Xe-135	$3 \times 10^0$	$2 \times 10^0$	$1 \times 10^3$	$1 \times 10^{10}$
Yttrium (39)				
Y-87 (a)	$1 \times 10^0$	$1 \times 10^0$	$1 \times 10^1$	$1 \times 10^6$
Y-88	$4 \times 10^{-1}$	$4 \times 10^{-1}$	$1 \times 10^1$	$1 \times 10^6$
Y-90	$3 \times 10^{-1}$	$3 \times 10^{-1}$	$1 \times 10^3$	$1 \times 10^5$
Y-91	$6 \times 10^{-1}$	$6 \times 10^{-1}$	$1 \times 10^3$	$1 \times 10^6$
Y-91m	$2 \times 10^0$	$2 \times 10^0$	$1 \times 10^2$	$1 \times 10^6$
Y-92	$2 \times 10^{-1}$	$2 \times 10^{-1}$	$1 \times 10^2$	$1 \times 10^5$
Y-93	$3 \times 10^{-1}$	$3 \times 10^{-1}$	$1 \times 10^2$	$1 \times 10^5$
Ytterbium (70)				
Yb-169	$4 \times 10^0$	$1 \times 10^0$	$1 \times 10^2$	$1 \times 10^7$
Yb-175	$3 \times 10^1$	$9 \times 10^{-1}$	$1 \times 10^3$	$1 \times 10^7$
Zinc (30)				
Zn-65	$2 \times 10^0$	$2 \times 10^0$	$1 \times 10^1$	$1 \times 10^6$
Zn-69	$3 \times 10^0$	$6 \times 10^{-1}$	$1 \times 10^4$	$1 \times 10^6$
Zn-69m (a)	$3 \times 10^0$	$6 \times 10^{-1}$	$1 \times 10^2$	$1 \times 10^6$
Zirconium (40)				
Zr-88	$3 \times 10^0$	$3 \times 10^0$	$1 \times 10^2$	$1 \times 10^6$
Zr-93	Unlimited	Unlimited	$1 \times 10^3$ (b)	$1 \times 10^7$ (b)
Zr-95 (a)	$2 \times 10^0$	$8 \times 10^{-1}$	$1 \times 10^1$	$1 \times 10^6$
Zr-97 (a)	$4 \times 10^{-1}$	$4 \times 10^{-1}$	$1 \times 10^1$ (b)	$1 \times 10^5$ (b)

(a)  $A_1$  and/or  $A_2$  values include contributions from daughter nuclides with half-lives less than 10 days.

(b) Parent nuclides and their progeny included in secular equilibrium are listed in the following:

Sr-90	Y-90
Zr-93	Nb-93m
Zr-97	Nb-97
Ru-106	Rh-106

## ACTIVITY LIMITS AND MATERIAL RESTRICTIONS

Cs-137	Ba-137m
Ce-134	La-134
Ce-144	Pr-144
Ba-140	La-140
Bi-212	Tl-208 (0.36), Po-212 (0.64)
Pb-210	Bi-210, Po-210
Pb-212	Bi-212, Tl-208 (0.36), Po-212 (0.64)
Rn-220	Po-216
Rn-222	Po-218, Pb-214, Bi-214, Po-214
Ra-223	Rn-219, Po-215, Pb-211, Bi-211, Tl-207
Ra-224	Rn-220, Po-216, Pb-212, Bi-212, Tl-208 (0.36), Po-212 (0.64)
Ra-226	Rn-222, Po-218, Pb-214, Bi-214, Po-214, Pb-210, Bi-210, Po-210
Ra-228	Ac-228
Th-226	Ra-222, Rn-218, Po-214
Th-228	Ra-224, Rn-220, Po-216, Pb-212, Bi-212, Tl-208 (0.36), Po-212 (0.64)
Th-229	Ra-225, Ac-225, Fr-221, At-217, Bi-213, Po-213, Pb-209
Th-nat	Ra-228, Ac-228, Th-228, Ra-224, Rn-220, Po-216, Pb-212, Bi-212, Tl-208 (0.36), Po-212 (0.64)
Th-234	Pa-234m
U-230	Th-226, Ra-222, Rn-218, Po-214
U-232	Th-228, Ra-224, Rn-220, Po-216, Pb-212, Bi-212, Tl-208 (0.36), Po-212 (0.64)
U-235	Th-231
U-238	Th-234, Pa-234m
U-nat	Th-234, Pa-234m, U-234, Th-230, Ra-226, Rn-222, Po-218, Pb-214, Bi-214, Po-214, Pb-210, Bi-210, Po-210
U-240	Np-240m
Np-237	Pa-233
Am-242m	Am-242
Am-243	Np-239

- (c) The quantity may be determined from a measurement of the rate of decay or a measurement of the radiation level at a prescribed distance from the source.
- (d) These values apply only to compounds of uranium that take the chemical form of  $UF_6$ ,  $UO_2F_2$  and  $UO_2(NO_3)_2$  in both normal and accident conditions of transport.
- (e) These values apply only to compounds of uranium that take the chemical form of  $UO_3$ ,  $UF_4$ ,  $UCl_4$  and hexavalent compounds in both normal and accident conditions of transport.
- (f) These values apply to all compounds of uranium other than those specified in (d) and (e) above.
- (g) These values apply to *unirradiated uranium* only.

## SECTION IV

where,

f(i) is the fraction of activity or activity concentration of radionuclide i in the mixture;

X(i) is the appropriate value of  $A_1$  or  $A_2$ , or the activity concentration for exempt material or the activity limit for an exempt consignment as appropriate for the radionuclide i; and

$X_m$  is the derived value of  $A_1$  or  $A_2$ , or the activity concentration for exempt material or the activity limit for an exempt consignment in the case of a mixture.

405. When the identity of each radionuclide is known but the individual activities of some of the radionuclides are not known, the radionuclides may be grouped and the lowest radionuclide value, as appropriate, for the radionuclides in each group may be used in applying the formulas in paras 404 and 414. Groups may be based on the total alpha activity and the total beta/gamma activity when these are known, using the lowest radionuclide values for the alpha emitters or beta/gamma emitters, respectively.

406. For individual radionuclides or for mixtures of radionuclides for which relevant data are not available, the values shown in Table II shall be used.

### CONTENTS LIMITS FOR PACKAGES

407. The quantity of *radioactive material* in a *package* shall not exceed the relevant limits specified in paras 408–419.

#### **Excepted packages**

408. For *radioactive material* other than articles manufactured of *natural uranium*, *depleted uranium* or natural thorium, an *excepted package* shall not contain activities greater than the following:

- (a) where the *radioactive material* is enclosed in or is included as a component part of an instrument or other manufactured article, such as a clock or electronic apparatus, the limits specified in columns 2 and 3 of Table III for each individual item and each *package*, respectively; and
- (b) where the *radioactive material* is not so enclosed in or is not included as a component of an instrument or other manufactured article, the *package* limits specified in column 4 of Table III.

ACTIVITY LIMITS AND MATERIAL RESTRICTIONS

TABLE II. BASIC RADIONUCLIDE VALUES FOR UNKNOWN RADIO-NUCLIDES OR MIXTURES

<i>Radioactive contents</i>	$A_1$	$A_2$	Activity concentration for exempt material	Activity limit for an exempt consignment
	(TBq)	(TBq)	(Bq/g)	(Bq)
Only beta or gamma emitting nuclides are known to be present	0.1	0.02	$1 \times 10^1$	$1 \times 10^4$
Only alpha emitting nuclides are known to be present	0.2	$9 \times 10^{-5}$	$1 \times 10^{-1}$	$1 \times 10^3$
No relevant data are available	0.001	$9 \times 10^{-5}$	$1 \times 10^{-1}$	$1 \times 10^3$

409. For articles manufactured of *natural uranium*, *depleted uranium* or natural thorium, an *excepted package* may contain any quantity of such material provided that the outer surface of the uranium or thorium is enclosed in an inactive sheath made of metal or some other substantial material.

410. For transport by post, the total activity in each *excepted package* shall not exceed one tenth of the relevant limit specified in Table III.

TABLE III. ACTIVITY LIMITS FOR EXCEPTED PACKAGES

Physical state of contents	Instrument or article		Materials
	Item limits <sup>a</sup>	Package limits <sup>a</sup>	Package limits <sup>a</sup>
Solids:			
<i>special form</i>	$10^{-2} A_1$	$A_1$	$10^{-3} A_1$
other forms	$10^{-2} A_2$	$A_2$	$10^{-3} A_2$
Liquids	$10^{-3} A_2$	$10^{-1} A_2$	$10^{-4} A_2$
Gases			
tritium	$2 \times 10^{-2} A_2$	$2 \times 10^{-1} A_2$	$2 \times 10^{-2} A_2$
<i>special form</i>	$10^{-3} A_1$	$10^{-2} A_1$	$10^{-3} A_1$
other forms	$10^{-3} A_2$	$10^{-2} A_2$	$10^{-3} A_2$

<sup>a</sup> For mixtures of radionuclides, see paras 404–406.

## SECTION IV

### Type IP-1, Type IP-2 and Type IP-3

411. The *radioactive contents* in a single *package* of *LSA material* or in a single *package* of *SCO* shall be so restricted that the *radiation level* specified in para. 521 shall not be exceeded, and the activity in a single *package* shall also be so restricted that the activity limits for a *conveyance* specified in para. 525 shall not be exceeded.

412. A single *package* of non-combustible solid *LSA-II* or *LSA-III material*, if carried by air, shall not contain an activity greater than  $3000 A_2$ .

### Type A packages

413. *Type A packages* shall not contain activities greater than the following:

- (a) for *special form radioactive material* —  $A_1$ ; or
- (b) for all other *radioactive material* —  $A_2$ .

414. For mixtures of radionuclides whose identities and respective activities are known, the following condition shall apply to the *radioactive contents* of a *Type A package*:

$$\sum_i \frac{B(i)}{A_1(i)} + \sum_j \frac{C(j)}{A_2(j)} \leq 1$$

where

B(i) is the activity of radionuclide i as *special form radioactive material* and  $A_1(i)$  is the  $A_1$  value for radionuclide i; and

C(j) is the activity of radionuclide j as other than *special form radioactive material* and  $A_2(j)$  is the  $A_2$  value for radionuclide j.

### Type B(U) and Type B(M) packages

415. *Type B(U)* and *Type B(M) packages* shall not contain:

- (a) activities greater than those authorized for the *package design*,
- (b) radionuclides different from those authorized for the *package design*, or
- (c) contents in a form, or a physical or chemical state different from those authorized for the *package design*,

as specified in their certificates of approval.

## ACTIVITY LIMITS AND MATERIAL RESTRICTIONS

416. *Type B(U)* and *Type B(M)* packages, if transported by air, shall meet the requirements of para. 415 and shall not contain activities greater than the following:

- (a) for *low dispersible radioactive material* — as authorized for the *package design* as specified in the certificate of approval,
- (b) for *special form radioactive material* —  $3000 A_1$  or  $100\,000 A_2$ , whichever is the lower; or
- (c) for all other *radioactive material* —  $3000 A_2$ .

### **Type C packages**

417. *Type C* packages shall not contain:

- (a) activities greater than those authorized for the *package design*,
- (b) radionuclides different from those authorized for the *package design*, or
- (c) contents in a form, or physical or chemical state different from those authorized for the *package design*,

as specified in their certificates of approval.

### **Packages containing fissile material**

418. Packages containing *fissile material* shall not contain:

- (a) a mass of *fissile material* different from that authorized for the *package design*,
- (b) any radionuclide or *fissile material* different from those authorized for the *package design*, or
- (c) contents in a form or physical or chemical state, or in a spatial arrangement, different from those authorized for the *package design*,

as specified in their certificates of approval where appropriate.

### **Packages containing uranium hexafluoride**

419. The mass of uranium hexafluoride in a *package* shall not exceed a value that would lead to an ullage smaller than 5% at the maximum temperature of the *package* as specified for the plant systems where the *package* shall be used. The uranium hexafluoride shall be in solid form and the internal pressure of the *package* shall be below atmospheric pressure when presented for transport.

## Section V

### REQUIREMENTS AND CONTROLS FOR TRANSPORT

#### REQUIREMENTS BEFORE THE FIRST SHIPMENT

501. Before the first *shipment* of any *package*, the following requirements shall be fulfilled:

- (a) If the design pressure of the *containment system* exceeds 35 kPa (gauge), it shall be ensured that the *containment system* of each *package* conforms to the approved design requirements relating to the capability of that system to maintain its integrity under that pressure.
- (b) For each *Type B(U)*, *Type B(M)* and *Type C package* and for each *package* containing *fissile material*, it shall be ensured that the effectiveness of its shielding and containment and, where necessary, the heat transfer characteristics and the effectiveness of the *confinement system*, are within the limits applicable to or specified for the approved *design*.
- (c) For *packages* containing *fissile material*, where, in order to comply with the requirements of para. 671, neutron poisons are specifically included as components of the *package*, checks shall be performed to confirm the presence and distribution of those neutron poisons.

#### REQUIREMENTS BEFORE EACH SHIPMENT

502. Before each *shipment* of any *package*, the following requirements shall be fulfilled:

- (a) For any *package* it shall be ensured that all the requirements specified in the relevant provisions of these Regulations have been satisfied.
- (b) It shall be ensured that lifting attachments which do not meet the requirements of para. 607 have been removed or otherwise rendered incapable of being used for lifting the *package*, in accordance with para. 608.
- (c) For each *Type B(U)*, *Type B(M)* and *Type C package* and for each *package* containing *fissile material*, it shall be ensured that all the requirements specified in the approval certificates have been satisfied.
- (d) Each *Type B(U)*, *Type B(M)* and *Type C package* shall be held until equilibrium conditions have been approached closely enough to demonstrate compliance with the requirements for temperature and pressure unless an exemption from these requirements has received *unilateral approval*.



## SECTION V

- (e) For each *Type B(U)*, *Type B(M)* and *Type C package*, it shall be ensured by inspection and/or appropriate tests that all closures, valve and other openings of the *containment system* through which the *radioactive contents* might escape are properly closed and, where appropriate, sealed in the manner for which the demonstrations of compliance with the requirements of paras 656 and 669 were made.
- (f) For each *special form radioactive material*, it shall be ensured that all the requirements specified in the approval certificate and the relevant provisions of these Regulations have been satisfied.
- (g) For *packages* containing *fissile material* the measurement specified in para. 674(b) and the tests to demonstrate closure of each *package* as specified in para. 677 shall be performed where applicable.
- (h) For each *low dispersible radioactive material*, it shall be ensured that all the requirements specified in the approval certificate and the relevant provisions of these Regulations have been satisfied.

### TRANSPORT OF OTHER GOODS

503. A *package* shall not contain any other items except such articles and documents as are necessary for the use of the *radioactive material*. This requirement shall not preclude the transport of *low specific activity material* or *surface contaminated objects* with other items. The transport of such articles and documents in a *package*, or of *low specific activity material* or *surface contaminated objects* with other items may be permitted provided that there is no interaction between them and the *packaging* or its *radioactive contents* that would reduce the safety of the *package*.

504. *Tanks* and *intermediate bulk containers* used for the transport of *radioactive material* shall not be used for the storage or transport of other goods unless decontaminated below the level of 0.4 Bq/cm<sup>2</sup> for beta and gamma emitters and *low toxicity alpha emitters* and 0.04 Bq/cm<sup>2</sup> for all other alpha emitters.

505. The transport of other goods with *consignments* being transported under *exclusive use* shall be permitted provided the arrangements are controlled only by the *consignor* and it is not prohibited by other regulations.

506. *Consignments* shall be segregated from other dangerous goods during transport in compliance with the relevant transport regulations for dangerous goods of each of the countries through or into which the materials will be transported, and, where applicable, with the regulations of the cognizant transport organizations, as well as these Regulations.

## REQUIREMENTS AND CONTROLS FOR TRANSPORT

### OTHER DANGEROUS PROPERTIES OF CONTENTS

507. In addition to the radioactive and fissile properties, any other dangerous properties of the contents of the *package*, such as explosiveness, flammability, pyrophoricity, chemical toxicity and corrosiveness, shall be taken into account in the packing, labelling, marking, placarding, storage and transport in order to be in compliance with the relevant transport regulations for dangerous goods of each of the countries through or into which the materials will be transported, and, where applicable, with the regulations of the cognizant transport organizations, as well as these Regulations.

### REQUIREMENTS AND CONTROLS FOR CONTAMINATION AND FOR LEAKING PACKAGES

508. The *non-fixed contamination* on the external surfaces of any *package* shall be kept as low as practicable and, under routine conditions of transport, shall not exceed the following limits:

- (a) 4 Bq/cm<sup>2</sup> for beta and gamma emitters and *low toxicity alpha emitters*, and
- (b) 0.4 Bq/cm<sup>2</sup> for all other alpha emitters.

These limits are applicable when averaged over any area of 300 cm<sup>2</sup> of any part of the surface.

509. Except as provided in para. 514, the level of *non-fixed contamination* on the external and internal surfaces of *overpacks, freight containers, tanks, intermediate bulk containers* and *conveyances* shall not exceed the limits specified in para. 508.

510. If it is evident that a *package* is damaged or leaking, or if it is suspected that the *package* may have leaked or been damaged, access to the *package* shall be restricted and a qualified person shall, as soon as possible, assess the extent of *contamination* and the resultant *radiation level* of the *package*. The scope of the assessment shall include the *package*, the *conveyance*, the adjacent loading and unloading areas, and, if necessary, all other material which has been carried in the *conveyance*. When necessary, additional steps for the protection of persons, property and the environment, in accordance with provisions established by the relevant *competent authority*, shall be taken to overcome and minimize the consequences of such leakage or damage.

511. *Packages* which are damaged or leaking *radioactive contents* in excess of allowable limits for normal conditions of transport may be removed to an acceptable

## SECTION V

interim location under supervision, but shall not be forwarded until repaired or reconditioned and decontaminated.

512. A *conveyance* and equipment used regularly for the transport of *radioactive material* shall be periodically checked to determine the level of *contamination*. The frequency of such checks shall be related to the likelihood of *contamination* and the extent to which *radioactive material* is transported.

513. Except as provided in para. 514, any *conveyance*, or equipment or part thereof which has become contaminated above the limits specified in para. 508 in the course of the transport of *radioactive material*, or which shows a *radiation level* in excess of 5  $\mu\text{Sv/h}$  at the surface, shall be decontaminated as soon as possible by a qualified person and shall not be re-used unless the *non-fixed contamination* does not exceed the limits specified in para. 508, and the *radiation level* resulting from the *fixed contamination* on surfaces after decontamination is less than 5  $\mu\text{Sv/h}$  at the surface.

514. A *freight container, tank, intermediate bulk container* or *conveyance* dedicated to the transport of unpackaged *radioactive material* under *exclusive use* shall be excepted from the requirements of paras 509 and 513 solely with regard to its internal surfaces and only for as long as it remains under that specific *exclusive use*.

### REQUIREMENTS AND CONTROLS FOR TRANSPORT OF EXCEPTED PACKAGES

515. *Excepted packages* shall be subject only to the following provisions in Sections V and VI:

- (a) The requirements specified in paras 507, 508, 511, 516, 534–536, 549(c), 554 and, as applicable 517–520;
- (b) The requirements for *excepted packages* specified in para. 620;
- (c) If the *excepted package* contains *fissile material*, one of the fissile exceptions provided by para. 672 shall apply and the requirement of para. 634 shall be met; and
- (d) The requirements in paras 579 and 580 if transported by post.

516. The *radiation level* at any point on the external surface of an *excepted package* shall not exceed 5  $\mu\text{Sv/h}$ .

517. *Radioactive material* which is enclosed in or is included as a component part of an instrument or other manufactured article, with activity not exceeding the item and

## REQUIREMENTS AND CONTROLS FOR TRANSPORT

*package* limits specified in columns 2 and 3 respectively of Table III, may be transported in an *excepted package* provided that:

- (a) The *radiation level* at 10 cm from any point on the external surface of any unpackaged instrument or article is not greater than 0.1 mSv/h; and
- (b) Each instrument or article bears the marking “RADIOACTIVE” except:
  - (i) radioluminescent timepieces or devices,
  - (ii) consumer products that either have received regulatory approval according to para. 107(d) or do not individually exceed the activity limit for an exempt *consignment* in Table I (column 5), provided that such products are transported in a *package* that bears the marking “RADIOACTIVE” on an internal surface in such a manner that warning of the presence of *radioactive material* is visible on opening the *package*; and
- (c) The active material is completely enclosed by non-active components (a device performing the sole function of containing *radioactive material* shall not be considered to be an instrument or manufactured article).

518. *Radioactive material* in forms other than as specified in para. 517, with an activity not exceeding the limit specified in column 4 of Table III, may be transported in an *excepted package* provided that:

- (a) the *package* retains its *radioactive contents* under routine conditions of transport; and
- (b) the *package* bears the marking “RADIOACTIVE” on an internal surface in such a manner that a warning of the presence of *radioactive material* is visible on opening the *package*.

519. A manufactured article in which the sole *radioactive material* is *unirradiated natural uranium, unirradiated depleted uranium* or *unirradiated natural thorium* may be transported as an *excepted package* provided that the outer surface of the uranium or thorium is enclosed in an inactive sheath made of metal or some other substantial material.

### **Additional requirements and controls for transport of empty packagings**

520. An empty *packaging* which had previously contained *radioactive material* may be transported as an *excepted package* provided that:

- (a) It is in a well maintained condition and securely closed;
- (b) The outer surface of any uranium or thorium in its structure is covered with an inactive sheath made of metal or some other substantial material;

## SECTION V

- (c) The level of internal *non-fixed contamination* does not exceed one hundred times the levels specified in para. 508; and
- (d) Any labels which may have been displayed on it in conformity with para. 541 are no longer visible.

### REQUIREMENTS AND CONTROLS FOR TRANSPORT OF LSA MATERIAL AND SCO IN INDUSTRIAL PACKAGES OR UNPACKAGED

521. The quantity of *LSA material* or *SCO* in a single *Type IP-1*, *Type IP-2*, *Type IP-3*, or object or collection of objects, whichever is appropriate, shall be so restricted that the external *radiation level* at 3 m from the unshielded material or object or collection of objects does not exceed 10 mSv/h.

522. *LSA material* and *SCO* which is or contains *fissile material* shall meet the applicable requirements of paras 568, 569 and 671.

523. *LSA material* and *SCO* in groups *LSA-I* and *SCO-I* may be transported unpackaged under the following conditions:

- (a) All unpackaged material other than ores containing only naturally occurring radionuclides shall be transported in such a manner that under routine conditions of transport there will be no escape of the *radioactive contents* from the *conveyance* nor will there be any loss of shielding;
- (b) Each *conveyance* shall be under *exclusive use*, except when only transporting *SCO-I* on which the *contamination* on the accessible and the inaccessible surfaces is not greater than ten times the applicable level specified in para. 214; and
- (c) For *SCO-I* where it is suspected that *non-fixed contamination* exists on inaccessible surfaces in excess of the values specified in para. 241(a)(i), measures shall be taken to ensure that the *radioactive material* is not released into the *conveyance*.

524. *LSA material* and *SCO*, except as otherwise specified in para. 523, shall be packaged in accordance with Table IV.

525. The total activity in a single hold or compartment of an inland water craft, or in another *conveyance*, for carriage of *LSA material* or *SCO* in *Type IP-1*, *Type IP-2*, *Type IP-3* or unpackaged, shall not exceed the limits shown in Table V.

**REQUIREMENTS AND CONTROLS FOR TRANSPORT**

TABLE IV. INDUSTRIAL PACKAGE REQUIREMENTS FOR LSA MATERIAL AND SCO

<i>Radioactive contents</i>	<i>Industrial package type</i>	
	<i>Exclusive use</i>	<i>Not under exclusive use</i>
<i>LSA-I</i>		
Solid <sup>a</sup>	<i>Type IP-1</i>	<i>Type IP-1</i>
Liquid	<i>Type IP-1</i>	<i>Type IP-2</i>
<i>LSA-II</i>		
Solid	<i>Type IP-2</i>	<i>Type IP-2</i>
Liquid and gas	<i>Type IP-2</i>	<i>Type IP-3</i>
<i>LSA-III</i>	<i>Type IP-2</i>	<i>Type IP-3</i>
<i>SCO-I</i> <sup>a</sup>	<i>Type IP-1</i>	<i>Type IP-1</i>
<i>SCO-II</i>	<i>Type IP-2</i>	<i>Type IP-2</i>

<sup>a</sup> Under the conditions specified in para. 523, *LSA-I material* and *SCO-I* may be transported unpackaged.

TABLE V. CONVEYANCE ACTIVITY LIMITS FOR LSA MATERIAL AND SCO IN INDUSTRIAL PACKAGES OR UNPACKAGED

Nature of material	Activity limit for conveyances other than by inland waterway	Activity limit for a hold or compartment of an inland water craft
<i>LSA-I</i>	No limit	No limit
<i>LSA-II</i> and <i>LSA-III</i> non-combustible solids	No limit	100 $A_2$
<i>LSA-II</i> and <i>LSA-III</i> combustible solids, and all liquids and gases	100 $A_2$	10 $A_2$
SCO	100 $A_2$	10 $A_2$

**DETERMINATION OF TRANSPORT INDEX (TI)**

526. The *transport index (TI)* for a *package, overpack or freight container*, or for unpackaged *LSA-I* or *SCO-I*, shall be the number derived in accordance with the following procedure:

SECTION V

- (a) Determine the maximum *radiation level* in units of millisieverts per hour (mSv/h) at a distance of 1 m from the external surfaces of the *package, overpack, freight container*, or unpackaged *LSA-I* and *SCO-I*. The value determined shall be multiplied by 100 and the resulting number is the *transport index*. For uranium and thorium ores and their concentrates, the maximum *radiation level* at any point 1 m from the external surface of the load may be taken as:
- 0.4 mSv/h for ores and physical concentrates of uranium and thorium;
  - 0.3 mSv/h for chemical concentrates of thorium;
  - 0.02 mSv/h for chemical concentrates of uranium, other than uranium hexafluoride.
- (b) For *tanks, freight containers* and unpackaged *LSA-I* and *SCO-I*, the value determined in step (a) above shall be multiplied by the appropriate factor from Table VI.
- (c) The value obtained in steps (a) and (b) above shall be rounded up to the first decimal place (e.g. 1.13 becomes 1.2), except that a value of 0.05 or less may be considered as zero.

TABLE VI. MULTIPLICATION FACTORS FOR TANKS, FREIGHT CONTAINERS, AND UNPACKAGED LSA-I AND SCO-I

Size of load <sup>a</sup>	Multiplication factor
size of load ≤ 1 m <sup>2</sup>	1
1 m <sup>2</sup> < size of load ≤ 5 m <sup>2</sup>	2
5 m <sup>2</sup> < size of load ≤ 20 m <sup>2</sup>	3
20 m <sup>2</sup> < size of load	10

<sup>a</sup> Largest cross-sectional area of the load being measured.

527. The *transport index* for each *overpack, freight container* or *conveyance* shall be determined as either the sum of the *TIs* of all the *packages* contained, or by direct measurement of *radiation level*, except in the case of non-rigid *overpacks* for which the *transport index* shall be determined only as the sum of the *TIs* of all the *packages*.

DETERMINATION OF CRITICALITY SAFETY INDEX (CSI)

528. The *criticality safety index (CSI)* for *packages* containing *fissile material* shall be obtained by dividing the number 50 by the smaller of the two values of *N* derived in paras 681 and 682 (i.e.  $CSI = 50/N$ ). The value of the *criticality safety index* may

## REQUIREMENTS AND CONTROLS FOR TRANSPORT

be zero, provided that an unlimited number of *packages* is subcritical (i.e. N is effectively equal to infinity in both cases).

529. The *criticality safety index* for each *overpack* or *freight container* shall be determined as the sum of the *CSIs* of all the *packages* contained. The same procedure shall be followed for determining the total sum of the *CSIs* in a *consignment* or aboard a *conveyance*.

### LIMITS ON TRANSPORT INDEX, CRITICALITY SAFETY INDEX AND RADIATION LEVELS FOR PACKAGES AND OVERPACKS

530. Except for *consignments* under *exclusive use*, the *transport index* of any *package* or *overpack* shall not exceed 10, nor shall the *criticality safety index* of any *package* or *overpack* exceed 50.

531. Except for *packages* or *overpacks* transported under *exclusive use* by rail or by road under the conditions specified in subpara. 572(a), or under *exclusive use* and *special arrangement* by vessel or by air under the conditions specified in paras 574 or 578 respectively, the maximum *radiation level* at any point on any external surface of a *package* or *overpack* shall not exceed 2 mSv/h.

532. The maximum *radiation level* at any point on any external surface of a *package* or *overpack* under *exclusive use* shall not exceed 10 mSv/h.

### CATEGORIES

533. *Packages* and *overpacks* shall be assigned to either category I-WHITE, II-YELLOW or III-YELLOW in accordance with the conditions specified in Table VII and with the following requirements:

- (a) For a *package* or *overpack*, both the *transport index* and the surface *radiation level* conditions shall be taken into account in determining which is the appropriate category. Where the *transport index* satisfies the condition for one category but the surface *radiation level* satisfies the condition for a different category, the *package* or *overpack* shall be assigned to the higher category. For this purpose, category I-WHITE shall be regarded as the lowest category.
- (b) The *transport index* shall be determined following the procedures specified in paras 526 and 527.



SECTION V

- (c) If the surface *radiation level* is greater than 2 mSv/h, the *package* or *overpack* shall be transported under *exclusive use* and under the provisions of paras 572(a), 574 or 578, as appropriate.
- (d) A *package* transported under a *special arrangement* shall be assigned to category III-YELLOW.
- (e) An *overpack* which contains *packages* transported under *special arrangement* shall be assigned to category III-YELLOW.

TABLE VII. CATEGORIES OF PACKAGES AND OVERPACKS

Conditions		
<i>Transport index</i>	Maximum <i>radiation level</i> at any point on external surface	Category
0 <sup>a</sup>	Not more than 0.005 mSv/h	I-WHITE
More than 0 but not more than 1 <sup>a</sup>	More than 0.005 mSv/h but not more than 0.5 mSv/h	II-YELLOW
More than 1 but not more than 10	More than 0.5 mSv/h but not more than 2 mSv/h	III-YELLOW
More than 10	More than 2 mSv/h but not more than 10 mSv/h	III-YELLOW <sup>b</sup>

<sup>a</sup> If the measured *TI* is not greater than 0.05, the value quoted may be zero in accordance with para. 526(c).

<sup>b</sup> Shall also be transported under *exclusive use*.

MARKING, LABELLING AND PLACARDING

**Marking**

534. Each *package* shall be legibly and durably marked on the outside of the *packaging* with an identification of either the *consignor* or *consignee*, or both.

535. For each *package*, other than *excepted packages*, the United Nations number (see Table VIII), preceded by the letters “UN”, and the proper shipping name (see Table VIII) shall be legibly and durably marked on the outside of the *packaging*. In the case of *excepted packages*, other than those accepted for international movement by post, only the United Nations number, preceded by the letters “UN”, shall be required. For *packages* accepted for international movement by post the requirement of para. 580 shall apply.

**REQUIREMENTS AND CONTROLS FOR TRANSPORT**

TABLE VIII. EXCERPTS FROM LIST OF UNITED NATIONS NUMBERS, PROPER SHIPPING NAMES AND DESCRIPTIONS, SUBSIDIARY RISKS AND THEIR RELATIONSHIP TO THE SCHEDULES

Schedule	UN No.	PROPER SHIPPING NAME <sup>a</sup> and description	Subsidiary risks
1	2910	RADIOACTIVE MATERIAL, EXCEPTED PACKAGE — LIMITED QUANTITY OF MATERIAL	
2	2911	RADIOACTIVE MATERIAL, EXCEPTED PACKAGE — INSTRUMENTS or ARTICLES	
3	2909	RADIOACTIVE MATERIAL, EXCEPTED PACKAGE — ARTICLES MANUFACTURED FROM NATURAL URANIUM or DEPLETED URANIUM or NATURAL THORIUM	
4	2908	RADIOACTIVE MATERIAL, EXCEPTED PACKAGE — EMPTY PACKAGING	
5	2912	RADIOACTIVE MATERIAL, LOW SPECIFIC ACTIVITY (LSA-I) non fissile or fissile-excepted <sup>b</sup>	
6	3321	RADIOACTIVE MATERIAL, LOW SPECIFIC ACTIVITY (LSA-II) non fissile or fissile-excepted <sup>b</sup>	
7	3322	RADIOACTIVE MATERIAL, LOW SPECIFIC ACTIVITY (LSA-III) non fissile or fissile-excepted <sup>b</sup>	
8	2913	RADIOACTIVE MATERIAL, SURFACE CONTAMINATED OBJECTS (SCO-I or SCO-II) non fissile or fissile-excepted <sup>b</sup>	
9	2915	RADIOACTIVE MATERIAL, TYPE A PACKAGE, non-special form, non fissile or fissile-excepted <sup>b</sup>	
9	3332	RADIOACTIVE MATERIAL, TYPE A PACKAGE, SPECIAL FORM non fissile or fissile-excepted <sup>b</sup>	
10	2916	RADIOACTIVE MATERIAL, TYPE B(U) PACKAGE, non fissile or fissile-excepted <sup>b</sup>	
11	2917	RADIOACTIVE MATERIAL, TYPE B(M) PACKAGE, non fissile or fissile-excepted <sup>b</sup>	
12	3323	RADIOACTIVE MATERIAL, TYPE C PACKAGE, non fissile or fissile-excepted <sup>b</sup>	
14	2919	RADIOACTIVE MATERIAL, TRANSPORTED UNDER SPECIAL ARRANGEMENT, non fissile or fissile-excepted <sup>b</sup>	

For footnotes see page 56.

## SECTION V

TABLE VIII. (cont.)

<sup>c</sup>	2978	RADIOACTIVE MATERIAL, URANIUM HEXA-FLUORIDE non fissile or fissile-excepted <sup>b</sup>	corrosive (UN Class 8)
6+13	3324	RADIOACTIVE MATERIAL, LOW SPECIFIC ACTIVITY (LSA-II), FISSILE	
7+13	3325	RADIOACTIVE MATERIAL, LOW SPECIFIC ACTIVITY (LSA-III), FISSILE	
8+13	3326	RADIOACTIVE MATERIAL, SURFACE CONTAMINATED OBJECTS (SCO-I or SCO-II), FISSILE	
9+13	3327	RADIOACTIVE MATERIAL, TYPE A PACKAGE, FISSILE non-special form	
9+13	3333	RADIOACTIVE MATERIAL, TYPE A PACKAGE, SPECIAL FORM, FISSILE	
10+13	3328	RADIOACTIVE MATERIAL, TYPE B(U) PACKAGE, FISSILE	
11+13	3329	RADIOACTIVE MATERIAL, TYPE B(M) PACKAGE, FISSILE	
12+13	3330	RADIOACTIVE MATERIAL, TYPE C PACKAGE, FISSILE	
14+13	3331	RADIOACTIVE MATERIAL, TRANSPORTED UNDER SPECIAL ARRANGEMENT, FISSILE	
<sup>c</sup> +13	2977	RADIOACTIVE MATERIAL, URANIUM HEXA-FLUORIDE, FISSILE	corrosive (UN Class 8)

<sup>a</sup> The “PROPER SHIPPING NAME” is found in the column “PROPER SHIPPING NAME and description” and is restricted to that part shown in CAPITAL LETTERS. In the case of UN 2909, UN 2911, UN 2913 and UN 3326 where alternative PROPER SHIPPING NAMES are separated by the word “or”, only the relevant PROPER SHIPPING NAME shall be used.

<sup>b</sup> “Fissile-excepted” applies only to those packages complying with para. 672.

<sup>c</sup> UN 2977 and UN 2978 are special cases without a unique relationship with the Schedules.

536. Each *package* of gross mass exceeding 50 kg shall have its permissible gross mass legibly and durably marked on the outside of the *packaging*.

537. Each *package* which conforms to:

- (a) an *IP-1*, an *IP-2* or an *IP-3 design* shall be legibly and durably marked on the outside of the *packaging* with “TYPE IP-1”, “TYPE IP-2” or “TYPE IP-3” as appropriate;

## REQUIREMENTS AND CONTROLS FOR TRANSPORT

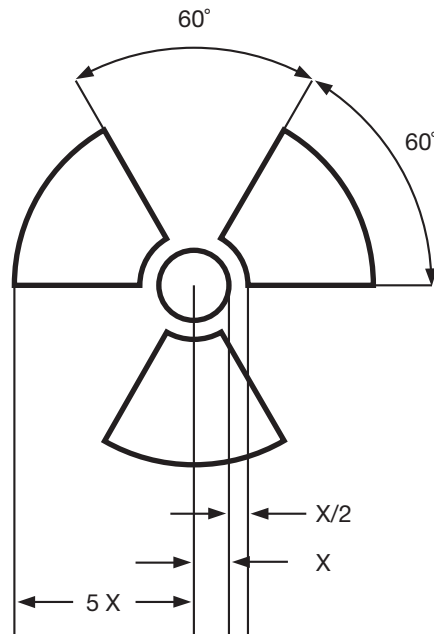

FIG. 1. Basic trefoil symbol with proportions based on a central circle of radius  $X$ . The minimum allowable size of  $X$  shall be 4 mm.

- (b) a *Type A* package design shall be legibly and durably marked on the outside of the *packaging* with “TYPE A”;
- (c) an *IP-2*, an *IP-3* or a *Type A* package design shall be legibly and durably marked on the outside of the *packaging* with the international *vehicle* registration code (VRI Code) of the country of origin of *design* and the name of the manufacturers, or other identification of the *packaging* specified by the *competent authority*.

538. Each *package* which conforms to a *design* approved under paras 805–814 or 816–817 shall be legibly and durably marked on the outside of the *packaging* with:

- (a) The identification mark allocated to that *design* by the *competent authority*;
- (b) A serial number to uniquely identify each *packaging* which conforms to that *design*;
- (c) In the case of a *Type B(U)* or *Type B(M)* package design, with “TYPE B(U)” or “TYPE B(M)”;
- (d) In the case of a *Type C* package design, with “TYPE C”.

539. Each *package* which conforms to a *Type B(U)*, *Type B(M)* or *Type C* package design shall have the outside of the outermost receptacle which is resistant to the effects of fire and water plainly marked by embossing, stamping or other means resistant to the effects of fire and water with the trefoil symbol shown in Fig. 1.

SECTION V

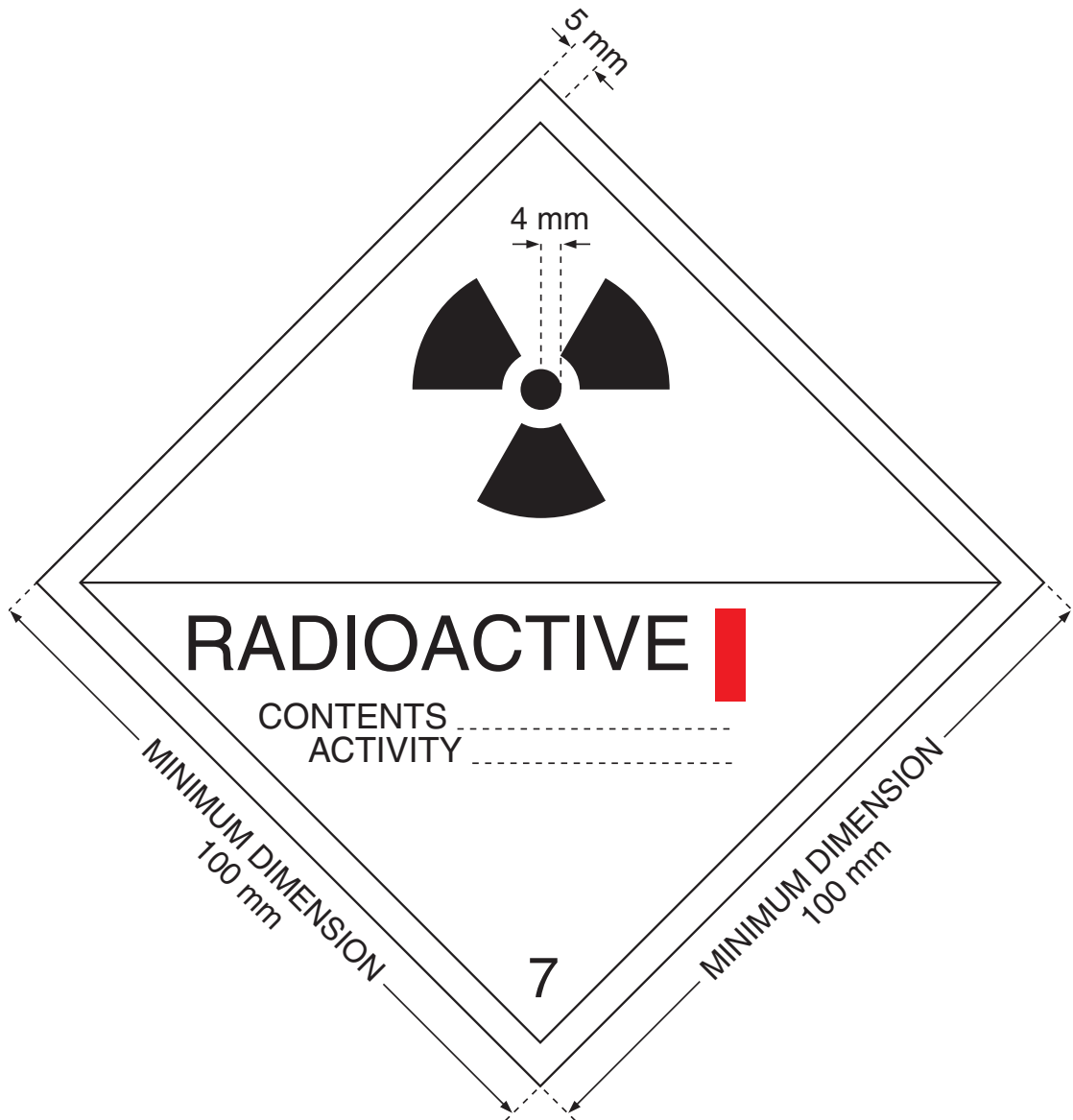

FIG. 2. Category I-WHITE label. The background colour of the label shall be white, the colour of the trefoil and the printing shall be black, and the colour of the category bar shall be red.

540. Where *LSA-I* or *SCO-I* material is contained in receptacles or wrapping materials and is transported under *exclusive use* as permitted by para. 523, the outer surface of these receptacles or wrapping materials may bear the marking 'RADIOACTIVE LSA-I' or 'RADIOACTIVE SCO-I' as appropriate.

**Labelling**

541. Each *package*, *overpack* and *freight container* shall bear the labels which conform to the models in Fig. 2, Fig. 3 or Fig. 4, except as allowed under the

REQUIREMENTS AND CONTROLS FOR TRANSPORT

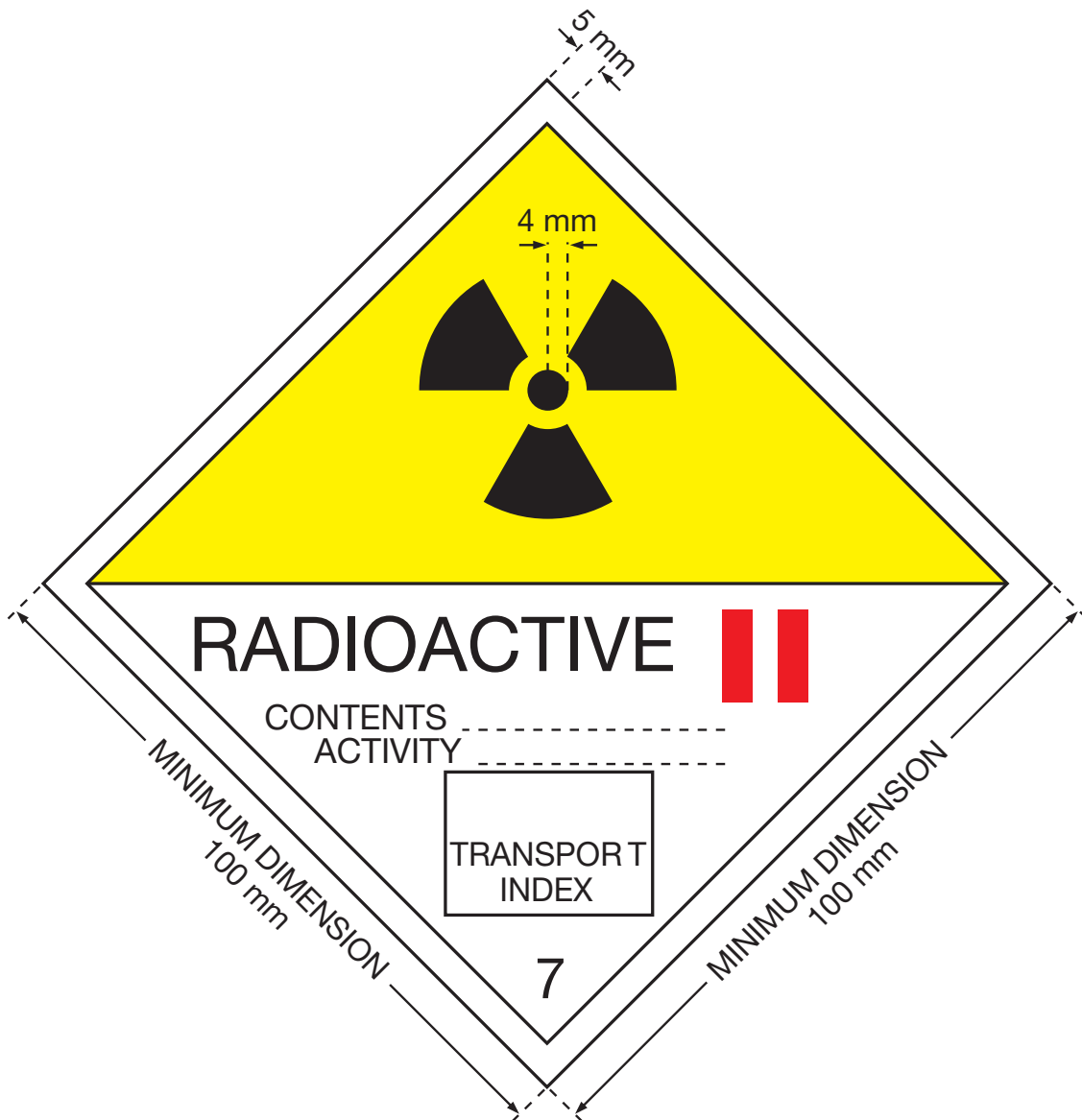

FIG. 3. Category II-YELLOW label. The background colour of the upper half of the label shall be yellow and the lower half white, the colour of the trefoil and the printing shall be black, and the colour of the category bars shall be red.

alternative provisions of para. 546 for large *freight containers* and *tanks*, according to the appropriate category. In addition, each *package*, *overpack* and *freight container* containing *fissile material*, other than *fissile material* excepted under the provisions of para. 672, shall bear labels which conform to the model in Fig. 5. Any labels which do not relate to the contents shall be removed or covered. For *radioactive material* having other dangerous properties see para. 507.

542. The labels conforming to the models in Fig. 2, Fig. 3 and Fig. 4 shall be affixed to two opposite sides of the outside of a *package* or *overpack* or on the outside of all

SECTION V

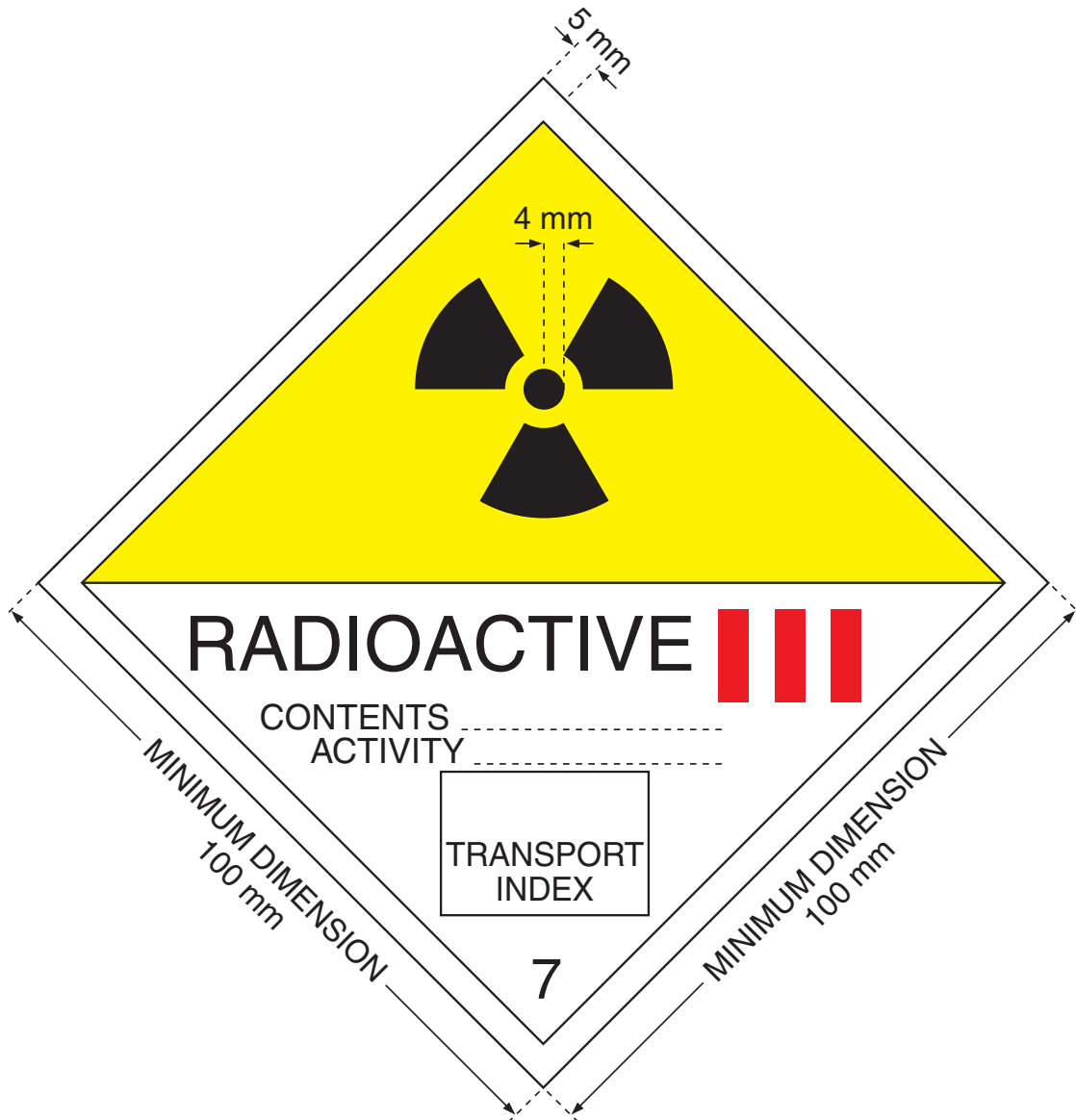

FIG. 4. Category III-YELLOW label. The background colour of the upper half of the label shall be yellow and the lower half white, the colour of the trefoil and the printing shall be black, and the colour of the category bars shall be red.

four sides of a *freight container* or *tank*. The labels conforming to the model in Fig. 5, where applicable, shall be affixed adjacent to the labels conforming to the models in Fig. 2, Fig. 3 and Fig. 4. The labels shall not cover the markings specified in paras 534–539.

**Labelling for radioactive contents**

543. Each label conforming to the models in Fig. 2, Fig. 3 and Fig. 4 shall be completed with the following information:

REQUIREMENTS AND CONTROLS FOR TRANSPORT

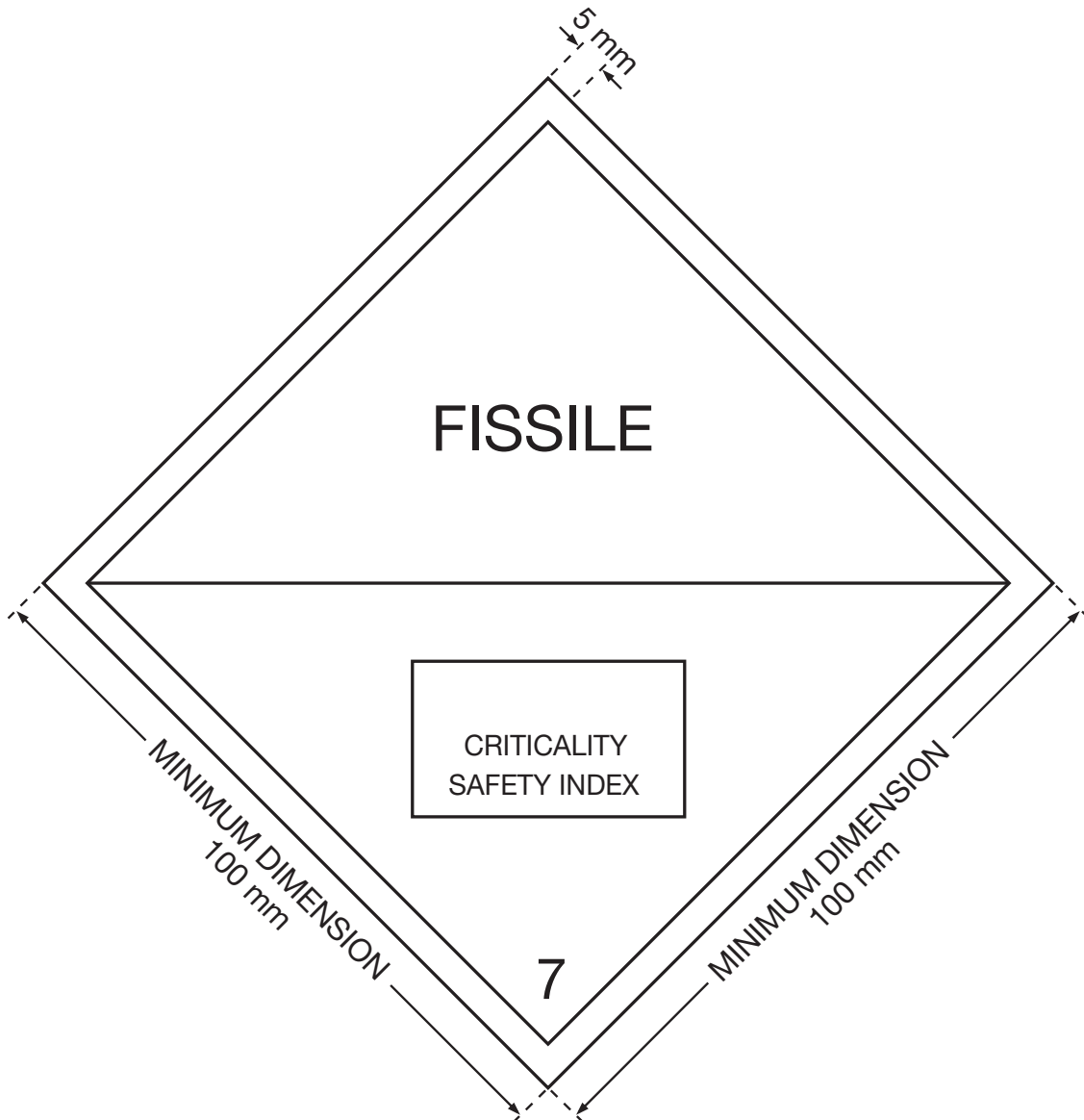

FIG. 5. Criticality safety index label. The background colour of the label shall be white, the colour of the printing shall be black.

- (a) Contents:
- (i) Except for *LSA-I material*, the name(s) of the radionuclide(s) as taken from Table I, using the symbols prescribed therein. For mixtures of radionuclides, the most restrictive nuclides must be listed to the extent the space on the line permits. The group of *LSA* or *SCO* shall be shown following the name(s) of the radionuclide(s). The terms “LSA-II”, “LSA-III”, “SCO-I” and “SCO-II” shall be used for this purpose.
  - (ii) For *LSA-I material*, the term “LSA-I” is all that is necessary; the name of the radionuclide is not necessary.



SECTION V

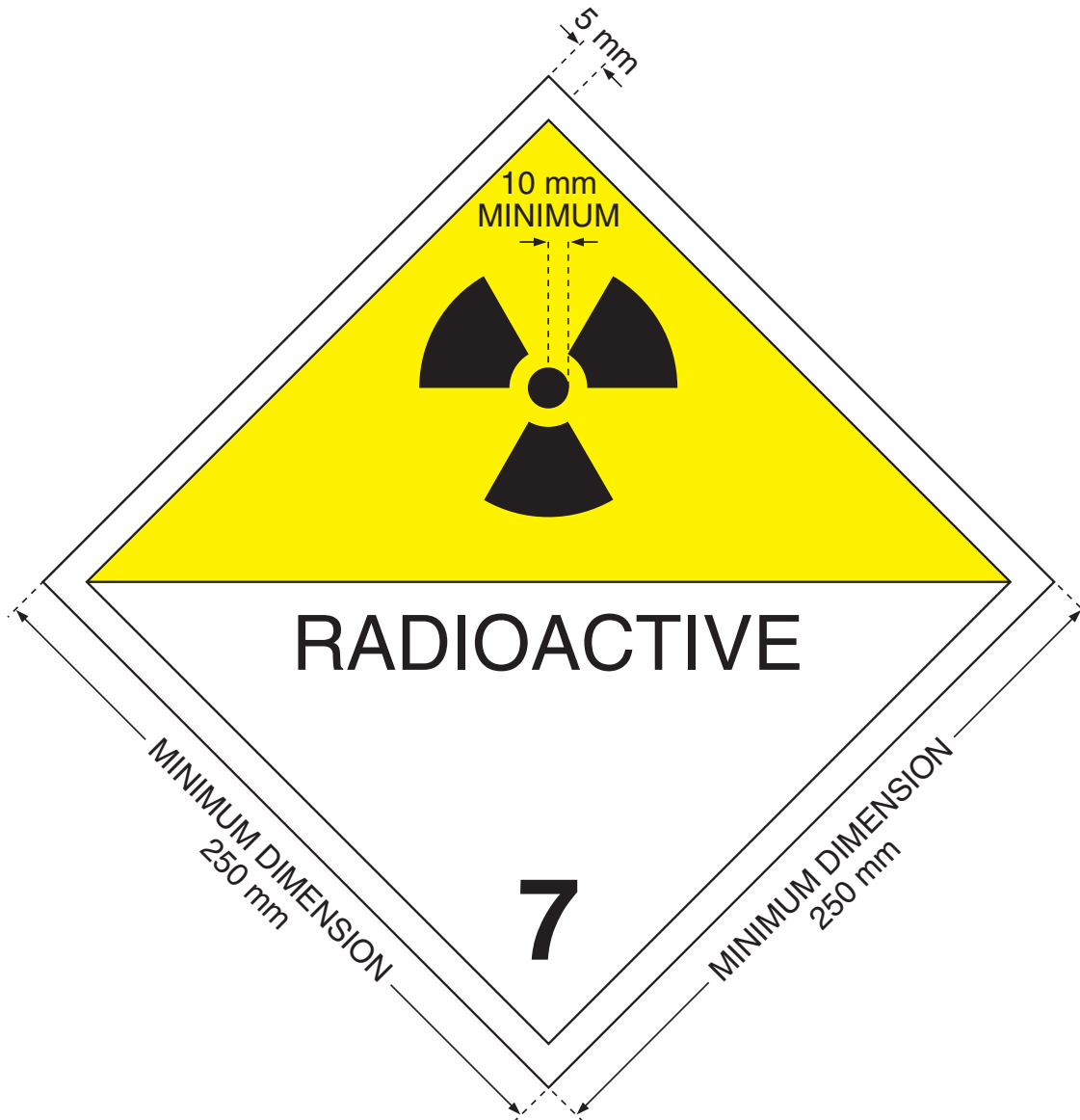

FIG. 6. Placard. Except as permitted by para. 570 minimum dimensions shall be as shown; when different dimensions are used the relative proportions must be maintained. The number '7' shall not be less than 25 mm high. The background colour of the upper half of the placard shall be yellow and of the lower half white, the colour of the trefoil and the printing shall be black. The use of the word "RADIOACTIVE" in the bottom half is optional to allow the alternative use of this placard to display the appropriate United Nations number for the consignment.

- (b) Activity: The maximum activity of the *radioactive contents* during transport expressed in units of becquerels (Bq) with the appropriate SI prefix (see Annex II). For *fissile material*, the mass of *fissile material* in units of grams (g), or multiples thereof, may be used in place of activity.

## REQUIREMENTS AND CONTROLS FOR TRANSPORT

- (c) For *overpacks* and *freight containers* the “contents” and “activity” entries on the label shall bear the information required in subparas 543(a) and 543(b), respectively, totalled together for the entire contents of the *overpack* or *freight container* except that on labels for *overpacks* or *freight containers* containing mixed loads of *packages* containing different radionuclides, such entries may read “See Transport Documents”.
- (d) *Transport index*: See paras 526 and 527. (No *transport index* entry is required for category I-WHITE.)

### Labelling for criticality safety

544. Each label conforming to the model in Fig. 5 shall be completed with the *criticality safety index (CSI)* as stated in the certificate of approval for *special arrangement* or the certificate of approval for the *package design* issued by the *competent authority*.

545. For *overpacks* and *freight containers*, the *criticality safety index (CSI)* on the label shall bear the information required in para. 544 totalled together for the fissile contents of the *overpack* or *freight container*.

### Placarding

546. Large *freight containers* carrying *packages* other than *excepted packages*, and *tanks* shall bear four placards which conform with the model given in Fig. 6. The placards shall be affixed in a vertical orientation to each side wall and each end wall of the large *freight container* or *tank*. Any placards which do not relate to the contents shall be removed. Instead of using both labels and placards, it is permitted as an alternative to use enlarged labels only, as shown in Fig. 2, Fig. 3, Fig. 4 and Fig. 5 where appropriate, with dimensions of the minimum size shown in Fig. 6.

547. Where the *consignment* in the *freight container* or *tank* is unpackaged *LSA-I* or *SCO-I* or where an *exclusive use consignment* in a *freight container* is packaged *radioactive material* with a single United Nations number, the appropriate United Nations number for the *consignment* (see Table VIII) shall also be displayed, in black digits not less than 65 mm high, either:

- (a) in the lower half of the placard shown in Fig. 6 and against the white background, or
- (b) on the placard shown in Fig. 7.

## SECTION V

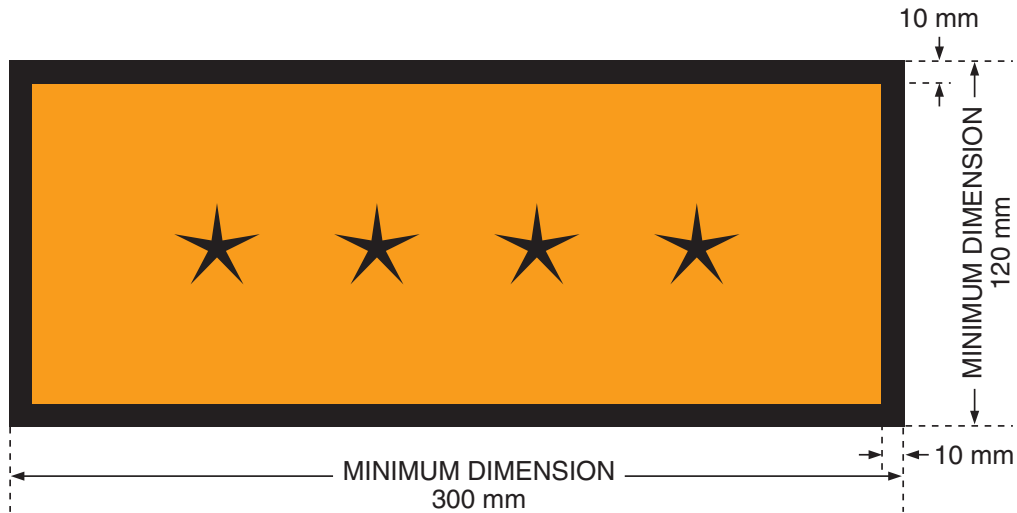

FIG. 7. Placard for separate display of United Nations number. The background colour of the placard shall be orange and the border and United Nations number shall be black. The symbol “\*\*\*\*” denotes the space in which the appropriate United Nations number for radioactive material, as specified in Table VIII, shall be displayed.

When the alternative given in (b) above is used, the subsidiary placard shall be affixed immediately adjacent to the main placard, on all four sides of the *freight container* or *tank*.

### CONSIGNOR’S RESPONSIBILITIES

548. Compliance with the requirements of paras 520(d) and 534–547 for marking, labelling and placarding shall be the responsibility of the *consignor*.

#### Particulars of consignment

549. The *consignor* shall include in the transport documents with each *consignment* the following information, as applicable in the order given:

- (a) The proper shipping name, as specified in Table VIII;
- (b) The United Nations Class number “7”;
- (c) The United Nations number assigned to the material as specified in Table VIII, preceded by the letters “UN”;
- (d) The name or symbol of each radionuclide or, for mixtures of radionuclides, an appropriate general description or a list of the most restrictive nuclides;

## REQUIREMENTS AND CONTROLS FOR TRANSPORT

- (e) A description of the physical and chemical form of the material, or a notation that the material is *special form radioactive material* or *low dispersible radioactive material*. A generic chemical description is acceptable for chemical form;
- (f) The maximum activity of the *radioactive contents* during transport expressed in units of becquerels (Bq) with an appropriate SI prefix (see Annex II). For *fissile material*, the mass of *fissile material* in units of grams (g), or appropriate multiples thereof, may be used in place of activity;
- (g) The category of the *package*, i.e. I-WHITE, II-YELLOW, III-YELLOW;
- (h) The *transport index* (categories II-YELLOW and III-YELLOW only);
- (i) For *consignments* including *fissile material* other than *consignments* excepted under para. 672, the *criticality safety index*;
- (j) The identification mark for each *competent authority* approval certificate (*special form radioactive material, low dispersible radioactive material, special arrangement, package design, or shipment*) applicable to the *consignment*;
- (k) For *consignments* of more than one *package*, the information contained in para. 549(a) to (j) shall be given for each *package*. For *packages* in an *overpack, freight container* or *conveyance*, a detailed statement of the contents of each *package* within the *overpack, freight container* or *conveyance* and, where appropriate, of each *overpack, freight container* or *conveyance* shall be included. If *packages* are to be removed from the *overpack, freight container* or *conveyance* at a point of intermediate unloading, appropriate transport documents shall be made available;
- (l) Where a *consignment* is required to be shipped under *exclusive use*, the statement “EXCLUSIVE USE SHIPMENT”; and
- (m) For *LSA-II, LSA-III, SCO-I* and *SCO-II*, the total activity of the *consignment* as a multiple of  $A_2$ .

### Consignor’s declaration

550. The *consignor* shall include in the transport documents a declaration in the following terms or in terms having an equivalent meaning:

“I hereby declare that the contents of this consignment are fully and accurately described above by the proper shipping name and are classified, packed, marked and labelled, and are in all respects in proper condition for transport by (insert mode(s) of transport involved) according to the applicable international and national governmental regulations.”

551. If the intent of the declaration is already a condition of transport within a particular international convention, the *consignor* need not provide such a declaration for that part of the transport covered by the convention.

## SECTION V

552. The declaration shall be signed and dated by the *consignor*. Facsimile signatures are acceptable where applicable laws and regulations recognize the legal validity of facsimile signatures.

553. The declaration shall be made on the same transport document which contains the particulars of *consignment* listed in para. 549.

### **Removal or covering of labels**

554. When an empty *packaging* is transported as an *excepted package* under the provisions of para. 520, the previously displayed labels shall not be visible.

### **Information for carriers**

555. The *consignor* shall provide in the transport documents a statement regarding actions, if any, that are required to be taken by the *carrier*. The statement shall be in the languages deemed necessary by the *carrier* or the authorities concerned, and shall include at least the following points:

- (a) Supplementary requirements for loading, stowage, carriage, handling and unloading of the *package, overpack* or *freight container* including any special stowage provisions for the safe dissipation of heat (see para. 565), or a statement that no such requirements are necessary;
- (b) Restrictions on the mode of transport or *conveyance* and any necessary routing instructions;
- (c) Emergency arrangements appropriate to the *consignment*.

556. The applicable *competent authority* certificates need not necessarily accompany the *consignment*. The *consignor* shall make them available to the *carrier(s)* before loading and unloading.

### **Notification of competent authorities**

557. Before the first *shipment* of any *package* requiring *competent authority* approval, the *consignor* shall ensure that copies of each applicable *competent authority* certificate applying to that *package design* have been submitted to the *competent authority* of each country through or into which the *consignment* is to be transported. The *consignor* is not required to await an acknowledgement from the *competent authority*, nor is the *competent authority* required to make such acknowledgement of receipt of the certificate.

## REQUIREMENTS AND CONTROLS FOR TRANSPORT

558. For each *shipment* listed in (a), (b), (c) or (d) below, the *consignor* shall notify the *competent authority* of each country through or into which the *consignment* is to be transported. This notification shall be in the hands of each *competent authority* prior to the commencement of the *shipment*, and preferably at least 7 days in advance.

- (a) *Type C packages* containing *radioactive material* with an activity greater than 3000  $A_1$  or 3000  $A_2$ , as appropriate, or 1000 TBq, whichever is the lower;
- (b) *Type B(U) packages* containing *radioactive material* with an activity greater than 3000  $A_1$  or 3000  $A_2$ , as appropriate, or 1000 TBq, whichever is the lower;
- (c) *Type B(M) packages*;
- (d) *Shipment under special arrangement*.

559. The *consignment* notification shall include:

- (a) Sufficient information to enable the identification of the *package* or *packages* including all applicable certificate numbers and identification marks;
- (b) Information on the date of *shipment*, the expected date of arrival and proposed routing;
- (c) The names of the *radioactive materials* or nuclides;
- (d) Descriptions of the physical and chemical forms of the *radioactive material*, or whether it is *special form radioactive material* or *low dispersible radioactive material*; and
- (e) The maximum activity of the *radioactive contents* during transport expressed in units of becquerels (Bq) with an appropriate SI prefix (see Annex II). For *fissile material*, the mass of *fissile material* in units of grams (g), or multiples thereof, may be used in place of activity.

560. The *consignor* is not required to send a separate notification if the required information has been included in the application for *shipment* approval; see para. 822.

### Possession of certificates and instructions

561. The *consignor* shall have in his or her possession a copy of each certificate required under Section VIII of these Regulations and a copy of the instructions with regard to the proper closing of the *package* and other preparations for *shipment* before making any *shipment* under the terms of the certificates.

## SECTION V

### TRANSPORT AND STORAGE IN TRANSIT

#### **Segregation during transport and storage in transit**

562. *Packages, overpacks and freight containers* containing *radioactive material* shall be segregated during transport and during storage in transit:

- (a) from places occupied by persons and from undeveloped photographic film, for radiation exposure control purposes, in accordance with paras 306 and 307, and
- (b) from other dangerous goods in accordance with para. 506.

563. Category II-YELLOW or III-YELLOW *packages* or *overpacks* shall not be carried in compartments occupied by passengers, except those exclusively reserved for couriers specially authorized to accompany such *packages* or *overpacks*.

#### **Stowage during transport and storage in transit**

564. *Consignments* shall be securely stowed.

565. Provided that its average surface heat flux does not exceed  $15 \text{ W/m}^2$  and that the immediately surrounding cargo is not in sacks or bags, a *package* or *overpack* may be carried or stored among packaged general cargo without any special stowage provisions except as may be specifically required by the *competent authority* in an applicable approval certificate.

566. Loading of *freight containers* and accumulation of *packages, overpacks* and *freight containers* shall be controlled as follows:

- (a) Except under the condition of *exclusive use*, the total number of *packages, overpacks* and *freight containers* aboard a single *conveyance* shall be so limited that the total sum of the *transport indexes* aboard the *conveyance* does not exceed the values shown in Table IX. For *consignments* of *LSA-I material* there shall be no limit on the sum of the *transport indexes*.
- (b) Where a *consignment* is transported under *exclusive use*, there shall be no limit on the sum of the *transport indexes* aboard a single *conveyance*.
- (c) The *radiation level* under routine conditions of transport shall not exceed  $2 \text{ mSv/h}$  at any point on, and  $0.1 \text{ mSv/h}$  at 2 m from, the external surface of the *conveyance*, except for *consignments* transported under *exclusive use* by road or rail, for which the radiation limits around the *vehicle* are set forth in para. 572(b) and (c).

## REQUIREMENTS AND CONTROLS FOR TRANSPORT

TABLE IX. TI LIMITS FOR FREIGHT CONTAINERS AND CONVEYANCES NOT UNDER EXCLUSIVE USE

Type of <i>freight container</i> or <i>conveyance</i>	Limit on total sum of <i>transport indexes</i> in a <i>freight container</i> or aboard a <i>conveyance</i>
<i>Freight container</i> — Small	50
<i>Freight container</i> — Large	50
<i>Vehicle</i>	50
<i>Aircraft</i>	
<i>Passenger</i>	50
<i>Cargo</i>	200
Inland water-way <i>vessel</i>	50
Seagoing <i>vessel</i> <sup>a</sup>	
(1) Hold, compartment or <i>defined deck area</i> :	
<i>Packages, overpacks, small freight containers</i>	50
<i>Large freight containers</i>	200
(2) Total <i>vessel</i> :	
<i>Packages, overpacks, small freight containers</i>	200
<i>Large freight containers</i>	No limit

<sup>a</sup> *Packages* or *overpacks* carried in or on a *vehicle* which are in accordance with the provisions of para. 572 may be transported by *vessels* provided that they are not removed from the *vehicle* at any time while on board the *vessel*.

(d) The total sum of the *criticality safety indexes* in a *freight container* and aboard a *conveyance* shall not exceed the values shown in Table X.

567. Any *package* or *overpack* having either a *transport index* greater than 10, or any *consignment* having a *criticality safety index* greater than 50, shall be transported only under *exclusive use*.

### **Segregation of packages containing fissile material during transport and storage in transit**

568. Any group of *packages, overpacks* and *freight containers* containing *fissile material* stored in transit in any one storage area shall be so limited that the total sum of the *criticality safety indexes* in the group does not exceed 50. Each group shall be stored so as to maintain a spacing of at least 6 m from other such groups.



SECTION V

569. Where the total sum of the *criticality safety indexes* on board a *conveyance* or in a *freight container* exceeds 50, as permitted in Table X, storage shall be such as to maintain a spacing of at least 6 m from other groups of *packages, overpacks* or *freight containers* containing *fissile material* or other *conveyances* carrying *radioactive material*.

TABLE X. CSI LIMITS FOR FREIGHT CONTAINERS AND CONVEYANCES CONTAINING FISSILE MATERIAL

Type of <i>freight container</i> or <i>conveyance</i>	Limit on total sum of <i>criticality safety indexes</i> in a <i>freight container</i> or aboard a <i>conveyance</i>	
	Not under <i>exclusive use</i>	Under <i>exclusive use</i>
<i>Freight container</i> — Small	50	n.a.
<i>Freight container</i> — Large	50	100
<i>Vehicle</i>	50	100
<i>Aircraft</i>		
<i>Passenger</i>	50	n.a.
<i>Cargo</i>	50	100
Inland water-way <i>vessel</i>	50	100
Seagoing <i>vessel</i> <sup>a</sup>		
(1) Hold, compartment or <i>defined deck area</i> : <i>Packages, overpacks, small freight containers</i>	50	100
Large <i>freight containers</i>	50	100
(2) Total <i>vessel</i> : <i>Packages, overpacks, small freight containers</i>	200 <sup>b</sup>	200 <sup>c</sup>
Large <i>freight containers</i>	No limit <sup>b</sup>	No limit <sup>c</sup>

<sup>a</sup> *Packages* or *overpacks* carried in or on a *vehicle* which are in accordance with the provisions of para. 572 may be transported by *vessels* provided that they are not removed from the *vehicle* at any time while on board the *vessel*. In that case the entries under the heading ‘under *exclusive use*’ apply.

<sup>b</sup> The *consignment* shall be so handled and stowed that the total sum of *CSI*’s in any group does not exceed 50, and that each group is handled and stowed so that the groups are separated from each other by at least 6 m.

<sup>c</sup> The *consignment* shall be so handled and stowed that the total sum of *CSI*’s in any group does not exceed 100, and that each group is handled and stowed so that the groups are separated from each other by at least 6 m. The intervening space between groups may be occupied by other cargo in accordance with para. 505.

## REQUIREMENTS AND CONTROLS FOR TRANSPORT

### Additional requirements relating to transport by rail and by road

570. Rail and road *vehicles* carrying *packages*, *overpacks* or *freight containers* labelled with any of the labels shown in Fig. 2, Fig. 3, Fig. 4 or Fig. 5, or carrying *consignments* under *exclusive use*, shall display the placard shown in Fig. 6 on each of:

- (a) The two external lateral walls in the case of a rail *vehicle*;
- (b) The two external lateral walls and the external rear wall in the case of a road *vehicle*.

In the case of a *vehicle* without sides, the placards may be affixed directly on the cargo-carrying unit provided that they are readily visible; in the case of physically large *tanks* or *freight containers*, the placards on the *tanks* or *freight containers* shall suffice. In the case of *vehicles* which have insufficient area to allow the fixing of larger placards, the dimensions of the placard as described in Fig. 6 may be reduced to 100 mm. Any placards which do not relate to the contents shall be removed.

571. Where the *consignment* in or on the *vehicle* is unpackaged *LSA-I material* or *SCO-I* or where an *exclusive use consignment* is packaged *radioactive material* with a single United Nations number, the appropriate United Nations number (see Table VIII) shall also be displayed, in black digits not less than 65 mm high, either:

- (a) In the lower half of the placard shown in Fig. 6, against the white background,  
or
- (b) On the placard shown in Fig. 7.

When the alternative given in (b) above is used, the subsidiary placard shall be affixed immediately adjacent to the main placard, either on the two external lateral walls in the case of a rail *vehicle* or the two external lateral walls and the external rear wall in the case of a road *vehicle*.

572. For *consignments* under *exclusive use*, the *radiation level* shall not exceed:

- (a) 10 mSv/h at any point on the external surface of any *package* or *overpack*, and may only exceed 2 mSv/h provided that:
  - (i) the *vehicle* is equipped with an enclosure which, during routine conditions of transport, prevents the access of unauthorized persons to the interior of the enclosure, and

## SECTION V

- (ii) provisions are made to secure the *package* or *overpack* so that its position within the *vehicle* enclosure remains fixed during routine conditions of transport, and
- (iii) there is no loading or unloading during the *shipment*;
- (b) 2 mSv/h at any point on the outer surfaces of the *vehicle*, including the upper and lower surfaces, or, in the case of an open *vehicle*, at any point on the vertical planes projected from the outer edges of the *vehicle*, on the upper surface of the load, and on the lower external surface of the *vehicle*; and
- (c) 0.1 mSv/h at any point 2 m from the vertical planes represented by the outer lateral surfaces of the *vehicle*, or, if the load is transported in an open *vehicle*, at any point 2 m from the vertical planes projected from the outer edges of the *vehicle*.

573. In the case of road *vehicles*, no persons other than the driver and assistants shall be permitted in *vehicles* carrying *packages*, *overpacks* or *freight containers* bearing category II-YELLOW or III-YELLOW labels.

### **Additional requirements relating to transport by vessels**

574. *Packages* or *overpacks* having a surface *radiation level* greater than 2 mSv/h, unless being carried in or on a *vehicle* under *exclusive use* in accordance with Table IX, footnote (a), shall not be transported by *vessel* except under *special arrangement*.

575. The transport of *consignments* by means of a special use *vessel* which, by virtue of its design, or by reason of its being chartered, is dedicated to the purpose of carrying *radioactive material*, shall be excepted from the requirements specified in para. 566 provided that the following conditions are met:

- (a) A *radiation protection programme* for the *shipment* shall be approved by the *competent authority* of the flag state of the *vessel* and, when requested, by the *competent authority* at each port of call;
- (b) Stowage arrangements shall be predetermined for the whole voyage including any *consignments* to be loaded at ports of call en route; and
- (c) The loading, carriage and unloading of the *consignments* shall be supervised by persons qualified in the transport of *radioactive material*.

### **Additional requirements relating to transport by air**

576. *Type B(M) packages* and *consignments* under *exclusive use* shall not be transported on *passenger aircraft*.

## REQUIREMENTS AND CONTROLS FOR TRANSPORT

577. Vented *Type B(M) packages*, *packages* which require external cooling by an ancillary cooling system, *packages* subject to operational controls during transport, and *packages* containing liquid pyrophoric materials shall not be transported by air.

578. *Packages* or *overpacks* having a surface *radiation level* greater than 2 mSv/h shall not be transported by air except by *special arrangement*.

### **Additional requirements relating to transport by post**

579. A *consignment* that conforms with the requirements of para. 515, and in which the activity of the *radioactive contents* does not exceed one tenth of the limits prescribed in Table III, may be accepted for domestic movement by national postal authorities, subject to such additional requirements as those authorities may prescribe.

580. A *consignment* that conforms with the requirements of para. 515, and in which the activity of the *radioactive contents* does not exceed one tenth of the limits prescribed in Table III, may be accepted for international movement by post, subject in particular to the following additional requirements as prescribed by the Acts of the Universal Postal Union:

- (a) it shall be deposited with the postal service only by *consignors* authorized by the national authority;
- (b) it shall be dispatched by the quickest route, normally by air;
- (c) it shall be plainly and durably marked on the outside with the words “RADIOACTIVE MATERIAL — QUANTITIES PERMITTED FOR MOVEMENT BY POST”; these words shall be crossed out if the *packaging* is returned empty;
- (d) it shall carry on the outside the name and address of the *consignor* with the request that the *consignment* be returned in the case of non-delivery; and
- (e) the name and address of the *consignor* and the contents of the *consignment* shall be indicated on the internal *packaging*.

## CUSTOMS OPERATIONS

581. Customs operations involving the inspection of the *radioactive contents* of a *package* shall be carried out only in a place where adequate means of controlling radiation exposure are provided and in the presence of qualified persons. Any *package* opened on customs instructions shall, before being forwarded to the *consignee*, be restored to its original condition.

## SECTION V

### UNDELIVERABLE CONSIGNMENTS

582. Where a *consignment* is undeliverable, the *consignment* shall be placed in a safe location and the appropriate *competent authority* shall be informed as soon as possible and a request made for instructions on further action.

## Section VI

### REQUIREMENTS FOR RADIOACTIVE MATERIALS AND FOR PACKAGINGS AND PACKAGES

#### REQUIREMENTS FOR RADIOACTIVE MATERIALS

##### Requirements for LSA-III material

601. *LSA-III material* shall be a solid of such a nature that if the entire contents of a *package* were subjected to the test specified in para. 703 the activity in the water would not exceed  $0.1 A_2$ .

##### Requirements for special form radioactive material

602. *Special form radioactive material* shall have at least one dimension not less than 5 mm.

603. *Special form radioactive material* shall be of such a nature or shall be so designed that if it is subjected to the tests specified in paras 704–711, it shall meet the following requirements:

- (a) It would not break or shatter under the impact, percussion and bending tests in paras 705, 706, 707 and 709(a) as applicable;
- (b) It would not melt or disperse in the heat test in para. 708 or para. 709(b) as applicable; and
- (c) The activity in the water from the leaching tests specified in paras 710 and 711 would not exceed 2 kBq; or alternatively for sealed sources, the leakage rate for the volumetric leakage assessment test specified in the International Organization for Standardization document ISO 9978: “Radiation Protection — Sealed Radioactive Sources — Leakage Test Methods” [8], would not exceed the applicable acceptance threshold acceptable to the *competent authority*.

604. When a sealed capsule constitutes part of the *special form radioactive material*, the capsule shall be so manufactured that it can be opened only by destroying it.

##### Requirements for low dispersible radioactive material

605. *Low dispersible radioactive material* shall be such that the total amount of this *radioactive material* in a *package* shall meet the following requirements:

## SECTION VI

- (a) The *radiation level* at 3 m from the unshielded *radioactive material* does not exceed 10 mSv/h;
- (b) If subjected to the tests specified in paras 736 and 737, the airborne release in gaseous and particulate forms of up to 100 µm aerodynamic equivalent diameter would not exceed 100  $A_2$ . A separate specimen may be used for each test; and
- (c) If subjected to the test specified in para. 703 the activity in the water would not exceed 100  $A_2$ . In the application of this test, the damaging effects of the tests specified in (b) above shall be taken into account.

### GENERAL REQUIREMENTS FOR ALL PACKAGINGS AND PACKAGES

606. The *package* shall be so designed in relation to its mass, volume and shape that it can be easily and safely transported. In addition, the *package* shall be so designed that it can be properly secured in or on the *conveyance* during transport.

607. The *design* shall be such that any lifting attachments on the *package* will not fail when used in the intended manner and that, if failure of the attachments should occur, the ability of the *package* to meet other requirements of these Regulations would not be impaired. The *design* shall take account of appropriate safety factors to cover snatch lifting.

608. Attachments and any other features on the outer surface of the *package* which could be used to lift it shall be designed either to support its mass in accordance with the requirements of para. 607 or shall be removable or otherwise rendered incapable of being used during transport.

609. As far as practicable, the *packaging* shall be so designed and finished that the external surfaces are free from protruding features and can be easily decontaminated.

610. As far as practicable, the outer layer of the *package* shall be so designed as to prevent the collection and the retention of water.

611. Any features added to the *package* at the time of transport which are not part of the *package* shall not reduce its safety.

612. The *package* shall be capable of withstanding the effects of any acceleration, vibration or vibration resonance which may arise under routine conditions of transport without any deterioration in the effectiveness of the closing devices on the various receptacles or in the integrity of the *package* as a whole. In particular, nuts,

## RADIOACTIVE MATERIALS AND PACKAGINGS AND PACKAGES

bolts and other securing devices shall be so designed as to prevent them from becoming loose or being released unintentionally, even after repeated use.

613. The materials of the *packaging* and any components or structures shall be physically and chemically compatible with each other and with the *radioactive contents*. Account shall be taken of their behaviour under irradiation.

614. All valves through which the *radioactive contents* could otherwise escape shall be protected against unauthorized operation.

615. The design of the *package* shall take into account ambient temperatures and pressures that are likely to be encountered in routine conditions of transport.

616. For *radioactive material* having other dangerous properties the *package design* shall take into account those properties; see paras 109 and 507.

## ADDITIONAL REQUIREMENTS FOR PACKAGES TRANSPORTED BY AIR

617. For *packages* to be transported by air, the temperature of the accessible surfaces shall not exceed 50°C at an ambient temperature of 38°C with no account taken for insolation.

618. *Packages* to be transported by air shall be so designed that, if they were exposed to ambient temperatures ranging from –40°C to +55°C, the integrity of containment would not be impaired.

619. *Packages* containing *radioactive material*, to be transported by air, shall be capable of withstanding, without leakage, an internal pressure that produces a pressure differential of not less than the *maximum normal operating pressure* plus 95 kPa.

## REQUIREMENTS FOR EXCEPTED PACKAGES

620. An *excepted package* shall be designed to meet the requirements specified in paras 606–616 and in addition, the requirements of paras 617–619 if carried by air.



## SECTION VI

### REQUIREMENTS FOR INDUSTRIAL PACKAGES

#### Requirements for Type IP-1

621. A *Type IP-1* shall be designed to meet the requirements specified in paras 606–616 and 634, and, in addition, the requirements of paras 617–619 if carried by air.

#### Requirements for Type IP-2

622. A *package*, to be qualified as a *Type IP-2*, shall be designed to meet the requirements for *Type IP-1* as specified in para. 621 and, in addition, if it were subjected to the tests specified in paras 722 and 723, it would prevent:

- (a) loss or dispersal of the *radioactive contents*; and
- (b) loss of shielding integrity which would result in more than a 20% increase in the *radiation level* at any external surface of the *package*.

#### Requirements for Type IP-3

623. A *package*, to be qualified as a *Type IP-3*, shall be designed to meet the requirements for *Type IP-1* as specified in para. 621 and, in addition, the requirements specified in paras 634–647.

#### Alternative requirements for Type IP-2 and Type IP-3

624. *Packages* may be used as *Type IP-2* provided that:

- (a) They satisfy the requirements for *Type IP-1* specified in para. 621;
- (b) They are designed to conform to the standards prescribed in the chapter on General Recommendations on Packing of the United Nations Recommendations on the Transport of Dangerous Goods [7], or other requirements at least equivalent to those standards; and
- (c) When subjected to the tests required for UN Packing Group I or II, they would prevent:
  - (i) loss or dispersal of the *radioactive contents*; and
  - (ii) loss of shielding integrity which would result in more than a 20% increase in the *radiation level* at any external surface of the *package*.

625. Tank containers may also be used as *Type IP-2* or *Type IP-3*, provided that:

## RADIOACTIVE MATERIALS AND PACKAGINGS AND PACKAGES

- (a) They satisfy the requirements for *Type IP-1* specified in para. 621;
- (b) They are designed to conform to the standards prescribed in the chapter on Recommendations on Multimodal Tank Transport of the United Nations Recommendations on the Transport of Dangerous Goods [7], or other requirements at least equivalent to those standards, and are capable of withstanding a test pressure of 265 kPa; and
- (c) They are designed so that any additional shielding which is provided shall be capable of withstanding the static and dynamic stresses resulting from handling and routine conditions of transport and of preventing a loss of shielding integrity which would result in more than a 20% increase in the *radiation level* at any external surface of the tank containers.

626. *Tanks*, other than tank containers, may also be used as *Type IP-2* or *Type IP-3* for transporting *LSA-I* and *LSA-II* liquids and gases as prescribed in Table IV, provided that they conform to standards at least equivalent to those prescribed in para. 625.

627. *Freight containers* may also be used as *Type IP-2* or *Type IP-3*, provided that:

- (a) The *radioactive contents* are restricted to solid materials;
- (b) They satisfy the requirements for *Type IP-1* specified in para. 621; and
- (c) They are designed to conform to the standards prescribed in the International Organization for Standardization document ISO 1496/1: “Series 1 Freight Containers — Specifications and Testing — Part 1: General Cargo Containers” [9] excluding dimensions and ratings. They shall be designed such that if subjected to the tests prescribed in that document and the accelerations occurring during routine conditions of transport they would prevent:
  - (i) loss or dispersal of the *radioactive contents*; and
  - (ii) loss of shielding integrity which would result in more than a 20% increase in the *radiation level* at any external surface of the *freight containers*.

628. Metal *intermediate bulk containers* may also be used as *Type IP-2* or *Type IP-3*, provided that:

- (a) They satisfy the requirements for *Type IP-1* specified in para. 621; and
- (b) They are designed to conform to the standards prescribed in the chapter on Recommendations on Intermediate Bulk Containers (IBC’s) of the United Nations Recommendations on the Transport of Dangerous Goods [7], for Packing Group I or II, and if they were subjected to the tests prescribed in that document, but with the drop test conducted in the most damaging orientation, they would prevent:

## SECTION VI

- (i) loss or dispersal of the *radioactive contents*; and
- (ii) loss of shielding integrity which would result in more than a 20% increase in the *radiation level* at any external surface of the *intermediate bulk container*.

### REQUIREMENTS FOR PACKAGES CONTAINING URANIUM HEXAFLUORIDE

629. *Packages* designed to contain uranium hexafluoride shall meet the requirements prescribed elsewhere in these Regulations which pertain to the radioactive and fissile properties of the material. Except as allowed in para. 632, uranium hexafluoride in quantities of 0.1 kg or more shall also be packaged and transported in accordance with the provisions of the International Organization for Standardization document ISO 7195: “Packaging of Uranium Hexafluoride (UF<sub>6</sub>) for Transport” [10], and the requirements of paras 630–631.

630. Each *package* designed to contain 0.1 kg or more of uranium hexafluoride shall be designed to meet the following requirements:

- (a) withstand without leakage and without unacceptable stress, as specified in the International Organization for Standardization document ISO 7195 [10], the structural test as specified in para. 718;
- (b) withstand without loss or dispersal of the uranium hexafluoride the free drop test specified in para. 722; and
- (c) withstand without rupture of the *containment system* the thermal test specified in para. 728.

631. *Packages* designed to contain 0.1 kg or more of uranium hexafluoride shall not be provided with pressure relief devices.

632. Subject to the approval of the *competent authority*, *packages* designed to contain 0.1 kg or more of uranium hexafluoride may be transported if:

- (a) the *packages* are designed to international or national standards other than ISO 7195 provided that an equivalent level of safety is maintained;
- (b) the *packages* are designed to withstand without leakage and without unacceptable stress a test pressure of less than 2.76 MPa as specified in para. 718; or
- (c) for *packages* designed to contain 9000 kg or more of uranium hexafluoride, the *packages* do not meet the requirement of para. 630(c).

## RADIOACTIVE MATERIALS AND PACKAGINGS AND PACKAGES

In all other respects the requirements specified in paras 629–631 shall be satisfied.

### REQUIREMENTS FOR TYPE A PACKAGES

633. *Type A packages* shall be designed to meet the requirements specified in paras 606–616 and, in addition, the requirements of paras 617–619 if carried by air, and of paras 634–649.

634. The smallest overall external dimension of the *package* shall not be less than 10 cm.

635. The outside of the *package* shall incorporate a feature such as a seal, which is not readily breakable and which, while intact, will be evidence that it has not been opened.

636. Any tie-down attachments on the *package* shall be so designed that, under normal and accident conditions of transport, the forces in those attachments shall not impair the ability of the *package* to meet the requirements of these Regulations.

637. The *design* of the *package* shall take into account temperatures ranging from  $-40^{\circ}\text{C}$  to  $+70^{\circ}\text{C}$  for the components of the *packaging*. Attention shall be given to freezing temperatures for liquids and to the potential degradation of *packaging* materials within the given temperature range.

638. The *design* and manufacturing techniques shall be in accordance with national or international standards, or other requirements, acceptable to the *competent authority*.

639. The *design* shall include a *containment system* securely closed by a positive fastening device which cannot be opened unintentionally or by a pressure which may arise within the *package*.

640. *Special form radioactive material* may be considered as a component of the *containment system*.

641. If the *containment system* forms a separate unit of the *package*, it shall be capable of being securely closed by a positive fastening device which is independent of any other part of the *packaging*.

## SECTION VI

642. The *design* of any component of the *containment system* shall take into account, where applicable, the radiolytic decomposition of liquids and other vulnerable materials and the generation of gas by chemical reaction and radiolysis.

643. The *containment system* shall retain its *radioactive contents* under a reduction of ambient pressure to 60 kPa.

644. All valves, other than pressure relief valves, shall be provided with an enclosure to retain any leakage from the valve.

645. A radiation shield which encloses a component of the *package* specified as a part of the *containment system* shall be so designed as to prevent the unintentional release of that component from the shield. Where the radiation shield and such component within it form a separate unit, the radiation shield shall be capable of being securely closed by a positive fastening device which is independent of any other *packaging* structure.

646. A *package* shall be so designed that if it were subjected to the tests specified in paras 719–724, it would prevent:

- (a) Loss or dispersal of the *radioactive contents*; and
- (b) Loss of shielding integrity which would result in more than a 20% increase in the *radiation level* at any external surface of the *package*.

647. The *design* of a *package* intended for liquid *radioactive material* shall make provision for ullage to accommodate variations in the temperature of the contents, dynamic effects and filling dynamics.

648. A *Type A package* designed to contain liquids shall, in addition:

- (a) Be adequate to meet the conditions specified in para. 646(a) if the *package* is subjected to the tests specified in para. 725; and
- (b) Either
  - (i) Be provided with sufficient absorbent material to absorb twice the volume of the liquid contents. Such absorbent material must be suitably positioned so as to contact the liquid in the event of leakage; or
  - (ii) Be provided with a *containment system* composed of primary inner and secondary outer containment components designed to ensure retention of the liquid contents, within the secondary outer containment components, even if the primary inner components leak.

## RADIOACTIVE MATERIALS AND PACKAGINGS AND PACKAGES

649. A *package* designed for gases shall prevent loss or dispersal of the *radioactive contents* if the *package* were subjected to the tests specified in para. 725. A *Type A package* designed for tritium gas or for noble gases shall be excepted from this requirement.

### REQUIREMENTS FOR TYPE B(U) PACKAGES

650. *Type B(U) packages* shall be designed to meet the requirements specified in paras 606–616, the requirements of paras 617–619 if carried by air, and of paras 634–647, except as specified in para. 646(a), and, in addition, the requirements specified in paras 651–664.

651. A *package* shall be so designed that, under the ambient conditions specified in paras 653 and 654, heat generated within the *package* by the *radioactive contents* shall not, under normal conditions of transport, as demonstrated by the tests in paras 719–724, adversely affect the *package* in such a way that it would fail to meet the applicable requirements for containment and shielding if left unattended for a period of one week. Particular attention shall be paid to the effects of heat, which may:

- (a) Alter the arrangement, the geometrical form or the physical state of the *radioactive contents* or, if the *radioactive material* is enclosed in a can or receptacle (for example, clad fuel elements), cause the can, receptacle or *radioactive material* to deform or melt; or
- (b) Lessen the efficiency of the *packaging* through differential thermal expansion or cracking or melting of the radiation shielding material; or
- (c) In combination with moisture, accelerate corrosion.

652. Except as required in para. 617 for a *package* transported by air, a *package* shall be so designed that, under the ambient condition specified in para. 653, the temperature of the accessible surfaces of a *package* shall not exceed 50°C, unless the *package* is transported under *exclusive use*.

653. The ambient temperature shall be assumed to be 38°C.

654. The solar insolation conditions shall be assumed to be as specified in Table XI.

655. A *package* which includes thermal protection for the purpose of satisfying the requirements of the thermal test specified in para. 728 shall be so designed that such protection will remain effective if the *package* is subjected to the tests specified in

## SECTION VI

TABLE XI. INSOLATION DATA

Case	Form and location of surface	Insolation for 12 hours per day (W/m <sup>2</sup> )
1	Flat surfaces transported horizontally — downward facing	0
2	Flat surfaces transported horizontally — upward facing	800
3	Surfaces transported vertically	200 <sup>a</sup>
4	Other downward facing (not horizontal) surfaces	200 <sup>a</sup>
5	All other surfaces	400 <sup>a</sup>

<sup>a</sup> Alternatively, a sine function may be used, with an absorption coefficient adopted and the effects of possible reflection from neighbouring objects neglected.

paras 719–724 and 727(a) and (b) or 727(b) and (c), as appropriate. Any such protection on the exterior of the *package* shall not be rendered ineffective by ripping, cutting, skidding, abrasion or rough handling.

656. A *package* shall be so designed that, if it were subjected to:

- (a) The tests specified in paras 719–724, it would restrict the loss of *radioactive contents* to not more than  $10^{-6} A_2$  per hour; and
- (b) The tests specified in paras 726, 727(b), 728 and 729 and the tests in paras:
  - (i) 727(c), when the *package* has a mass not greater than 500 kg, an overall density not greater than 1000 kg/m<sup>3</sup> based on the external dimensions, and *radioactive contents* greater than 1000  $A_2$  not as *special form radioactive material*, or
  - (ii) 727(a), for all other *packages*,
 it would meet the following requirements:
  - (i) retain sufficient shielding to ensure that the *radiation level* at 1 m from the surface of the *package* would not exceed 10 mSv/h with the maximum *radioactive contents* which the *package* is designed to contain; and
  - (ii) restrict the accumulated loss of *radioactive contents* in a period of one week to not more than 10  $A_2$  for krypton-85 and not more than  $A_2$  for all other radionuclides.

Where mixtures of different radionuclides are present, the provisions of paras 404–406 shall apply except that for krypton-85 an effective  $A_2(i)$  value equal to 10  $A_2$  may be used. For case (a) above, the assessment shall take into account the external *contamination* limits of para. 508.

## RADIOACTIVE MATERIALS AND PACKAGINGS AND PACKAGES

657. A *package* for *radioactive contents* with activity greater than  $10^5 A_2$  shall be so designed that if it were subjected to the enhanced water immersion test specified in para. 730, there would be no rupture of the *containment system*.

658. Compliance with the permitted activity release limits shall depend neither upon filters nor upon a mechanical cooling system.

659. A *package* shall not include a pressure relief system from the *containment system* which would allow the release of *radioactive material* to the environment under the conditions of the tests specified in paras 719–724 and 726–729.

660. A *package* shall be so designed that if it were at the *maximum normal operating pressure* and it were subjected to the tests specified in paras 719–724 and 726–729, the level of strains in the *containment system* would not attain values which would adversely affect the *package* in such a way that it would fail to meet the applicable requirements.

661. A *package* shall not have a *maximum normal operating pressure* in excess of a gauge pressure of 700 kPa.

662. Except as required in para. 617 for a *package* transported by air, the maximum temperature of any surface readily accessible during transport of a *package* shall not exceed 85°C in the absence of insolation under the ambient conditions specified in para. 653. The *package* shall be carried under *exclusive use*, as specified in para. 652, if this maximum temperature exceeds 50°C. Account may be taken of barriers or screens intended to give protection to persons without the need for the barriers or screens being subject to any test.

663. A *package* containing *low dispersible radioactive material* shall be so designed that any features added to the *low dispersible radioactive material* that are not part of it, or any internal components of the *packaging* shall not adversely affect the performance of the *low dispersible radioactive material*.

664. A *package* shall be designed for an ambient temperature range from –40°C to +38°C.

## REQUIREMENTS FOR TYPE B(M) PACKAGES

665. *Type B(M) packages* shall meet the requirements for *Type B(U) packages* specified in para. 650, except that for *packages* to be transported solely within a



## SECTION VI

specified country or solely between specified countries, conditions other than those given in paras 637, 653, 654 and 657–664 above may be assumed with the approval of the *competent authorities* of these countries. Notwithstanding, the requirements for *Type B(U) packages* specified in paras 657–664 shall be met as far as practicable.

666. Intermittent venting of *Type B(M) packages* may be permitted during transport, provided that the operational controls for venting are acceptable to the relevant *competent authorities*.

### REQUIREMENTS FOR TYPE C PACKAGES

667. *Type C packages* shall be designed to meet the requirements specified in paras 606–619, and of paras 634–647, except as specified in para. 646(a), and of the requirements specified in paras 651–654, paras 658–664, and, in addition, of paras 668–670.

668. A *package* shall be capable of meeting the assessment criteria prescribed for tests in paras 656(b) and 660 after burial in an environment defined by a thermal conductivity of 0.33 W/(m·K) and a temperature of 38°C in the steady state. Initial conditions for the assessment shall assume that any thermal insulation of the *package* remains intact, the *package* is at the *maximum normal operating pressure* and the ambient temperature is 38°C.

669. A *package* shall be so designed that, if it were at the *maximum normal operating pressure* and subjected to:

- (a) the tests specified in paras 719–724, it would restrict the loss of *radioactive contents* to not more than  $10^{-6} A_2$  per hour; and
- (b) the test sequences in para. 734, it would meet the following requirements:
  - (i) retain sufficient shielding to ensure that the *radiation level* at 1 m from the surface of the *package* would not exceed 10 mSv/h with the maximum *radioactive contents* which the *package* is designed to contain; and
  - (ii) restrict the accumulated loss of *radioactive contents* in a period of one week to not more than  $10 A_2$  for krypton-85 and not more than  $A_2$  for all other radionuclides.

Where mixtures of different radionuclides are present, the provisions of paras 404–406 shall apply except that for krypton-85 an effective  $A_2(i)$  value equal to  $10 A_2$  may be used. For case (a) above, the assessment shall take into account the external *contamination* limits of para. 508.

## RADIOACTIVE MATERIALS AND PACKAGINGS AND PACKAGES

670. A *package* shall be so designed that there will be no rupture of the *containment system* following performance of the enhanced water immersion test specified in para. 730.

### REQUIREMENTS FOR PACKAGES CONTAINING FISSILE MATERIAL

671. *Fissile material* shall be transported so as to;

- (a) maintain subcriticality during normal and accident conditions of transport; in particular, the following contingencies shall be considered:
  - (i) water leaking into or out of *packages*;
  - (ii) the loss of efficiency of built-in neutron absorbers or moderators;
  - (iii) rearrangement of the contents either within the *package* or as a result of loss from the *package*;
  - (iv) reduction of spaces within or between *packages*;
  - (v) *packages* becoming immersed in water or buried in snow; and
  - (vi) temperature changes; and
- (b) meet the requirements:
  - (i) of para. 634 for *packages* containing *fissile material*;
  - (ii) prescribed elsewhere in these Regulations which pertain to the radioactive properties of the material; and
  - (iii) specified in paras 673–682, unless excepted by para. 672.

### Exceptions from the requirements for packages containing fissile material

672. *Fissile material* meeting one of the provisions (a)–(d) of this paragraph is excepted from the requirement to be transported in *packages* that comply with paras 673–682 as well as the other requirements of these Regulations that apply to *fissile material*. Only one type of exception is allowed per *consignment*.

- (a) A mass limit per *consignment* such that:

$$\frac{\text{mass of uranium-235 (g)}}{X} + \frac{\text{mass of other fissile material (g)}}{Y} < 1$$

where X and Y are the mass limits defined in Table XII, provided that either:

SECTION VI

TABLE XII. CONSIGNMENT MASS LIMITS FOR EXCEPTIONS FROM THE REQUIREMENTS FOR PACKAGES CONTAINING FISSILE MATERIAL

<i>Fissile material</i>	<i>Fissile material</i> mass (g) mixed with substances having an average hydrogen density less than or equal to water	<i>Fissile material</i> mass (g) mixed with substances having an average hydrogen density greater than water
Uranium-235 (X)	400	290
Other <i>fissile material</i> (Y)	250	180

- (i) each individual *package* contains not more than 15 g of *fissile material*; for unpackaged material, this quantity limitation shall apply to the *consignment* being carried in or on the *conveyance*, or
- (ii) the *fissile material* is a homogeneous hydrogenous solution or mixture where the ratio of fissile nuclides to hydrogen is less than 5% by mass, or
- (iii) there is not more than 5 g of *fissile material* in any 10 litre volume of material.

Neither beryllium nor deuterium in hydrogenous material enriched in deuterium shall be present in quantities exceeding 1% of the applicable consignment mass limits provided in Table XII.

- (b) Uranium enriched in uranium-235 to a maximum of 1% by mass, and with a total plutonium and uranium-233 content not exceeding 1% of the mass of uranium-235, provided that the *fissile material* is distributed essentially homogeneously throughout the material. In addition, if uranium-235 is present in metallic, oxide or carbide forms, it shall not form a lattice arrangement.
- (c) Liquid solutions of uranyl nitrate enriched in uranium-235 to a maximum of 2% by mass, with a total plutonium and uranium-233 content not exceeding 0.002% of the mass of uranium, and with a minimum nitrogen to uranium atomic ratio (N/U) of 2.
- (d) Packages containing, individually, a total plutonium mass not more than 1 kg, of which not more than 20% by mass may consist of plutonium-239, plutonium-241 or any combination of those radionuclides.

**Contents specification for assessments of packages containing fissile material**

673. Where the chemical or physical form, isotopic composition, mass or concentration, moderation ratio or density, or geometric configuration is not known, the assessments of paras 677–682 shall be performed assuming that each parameter

## RADIOACTIVE MATERIALS AND PACKAGINGS AND PACKAGES

that is not known has the value which gives the maximum neutron multiplication consistent with the known conditions and parameters in these assessments.

674. For irradiated nuclear fuel the assessments of paras 677–682 shall be based on an isotopic composition demonstrated to provide:

- (a) the maximum neutron multiplication during the irradiation history, or
- (b) a conservative estimate of the neutron multiplication for the *package* assessments. After irradiation but prior to *shipment*, a measurement shall be performed to confirm the conservatism of the isotopic composition.

### Geometry and temperature requirements

675. The *package*, after being subjected to the tests specified in paras 719–724, must prevent the entry of a 10 cm cube.

676. The *package* shall be designed for an ambient temperature range of  $-40^{\circ}\text{C}$  to  $+38^{\circ}\text{C}$  unless the *competent authority* specifies otherwise in the certificate of approval for the *package design*.

### Assessment of an individual package in isolation

677. For a *package* in isolation, it shall be assumed that water can leak into or out of all void spaces of the *package*, including those within the *containment system*. However, if the *design* incorporates special features to prevent such leakage of water into or out of certain void spaces, even as a result of error, absence of leakage may be assumed in respect of those void spaces. Special features shall include the following:

- (a) Multiple high standard water barriers, each of which would remain watertight if the *package* were subject to the tests prescribed in para. 682(b), a high degree of quality control in the manufacture, maintenance and repair of *packagings* and tests to demonstrate the closure of each *package* before each *shipment*; or
- (b) For *packages* containing uranium hexafluoride only:
  - (i) *packages* where, following the tests prescribed in para. 682(b), there is no physical contact between the valve and any other component of the *packaging* other than at its original point of attachment and where, in addition, following the test prescribed in para. 728 the valves remain leaktight; and
  - (ii) a high degree of quality control in the manufacture, maintenance and repair of *packagings* coupled with tests to demonstrate closure of each *package* before each *shipment*.

## SECTION VI

678. It shall be assumed that the *confinement system* shall be closely reflected by at least 20 cm of water or such greater reflection as may additionally be provided by the surrounding material of the *packaging*. However, when it can be demonstrated that the *confinement system* remains within the *packaging* following the tests prescribed in para. 682(b), close reflection of the *package* by at least 20 cm of water may be assumed in para. 679(c).

679. The *package* shall be subcritical under the conditions of paras 677 and 678 with the *package* conditions that result in the maximum neutron multiplication consistent with:

- (a) routine conditions of transport (incident free);
- (b) the tests specified in para. 681(b);
- (c) the tests specified in para. 682(b).

680. For *packages* to be transported by air:

- (a) the *package* shall be subcritical under conditions consistent with the Type C package tests specified in para. 734 assuming reflection by at least 20 cm of water but no water in-leakage; and
- (b) in the assessment of para. 679 allowance shall not be made for special features of para. 677 unless, following the Type C package tests specified in para. 734 and, subsequently, the water in-leakage test of para. 733, leakage of water into or out of the void spaces is prevented.

### **Assessment of package arrays under normal conditions of transport**

681. A number “N” shall be derived, such that five times “N” shall be subcritical for the arrangement and *package* conditions that provide the maximum neutron multiplication consistent with the following:

- (a) There shall not be anything between the *packages*, and the *package* arrangement shall be reflected on all sides by at least 20 cm of water; and
- (b) The state of the *packages* shall be their assessed or demonstrated condition if they had been subjected to the tests specified in paras 719–724.

### **Assessment of package arrays under accident conditions of transport**

682. A number “N” shall be derived, such that two times “N” shall be subcritical for the arrangement and *package* conditions that provide the maximum neutron multiplication consistent with the following:

## RADIOACTIVE MATERIALS AND PACKAGINGS AND PACKAGES

- (a) Hydrogenous moderation between *packages*, and the *package* arrangement reflected on all sides by at least 20 cm of water; and
- (b) The tests specified in paras 719–724 followed by whichever of the following is the more limiting:
  - (i) the tests specified in para. 727(b) and, either para. 727(c) for *packages* having a mass not greater than 500 kg and an overall density not greater than 1000 kg/m<sup>3</sup> based on the external dimensions, or para. 727(a) for all other *packages*; followed by the test specified in para. 728 and completed by the tests specified in paras 731–733; or
  - (ii) the test specified in para. 729; and
- (c) Where any part of the *fissile material* escapes from the *containment system* following the tests specified in para. 682(b), it shall be assumed that *fissile material* escapes from each *package* in the array and all of the *fissile material* shall be arranged in the configuration and moderation that results in the maximum neutron multiplication with close reflection by at least 20 cm of water.

## Section VII

### TEST PROCEDURES

#### DEMONSTRATION OF COMPLIANCE

701. Demonstration of compliance with the performance standards required in Section VI shall be accomplished by any of the methods listed below or by a combination thereof.

- (a) Performance of tests with specimens representing *LSA-III material*, or *special form radioactive material*, or *low dispersible radioactive material* or with prototypes or samples of the *packaging*, where the contents of the specimen or the *packaging* for the tests shall simulate as closely as practicable the expected range of *radioactive contents* and the specimen or *packaging* to be tested shall be prepared as presented for transport.
- (b) Reference to previous satisfactory demonstrations of a sufficiently similar nature.
- (c) Performance of tests with models of appropriate scale incorporating those features which are significant with respect to the item under investigation when engineering experience has shown results of such tests to be suitable for design purposes. When a scale model is used, the need for adjusting certain test parameters, such as penetrator diameter or compressive load, shall be taken into account.
- (d) Calculation, or reasoned argument, when the calculation procedures and parameters are generally agreed to be reliable or conservative.

702. After the specimen, prototype or sample has been subjected to the tests, appropriate methods of assessment shall be used to ensure that the requirements of this section have been fulfilled in compliance with the performance and acceptance standards prescribed in Section VI.

#### LEACHING TEST FOR LSA-III MATERIAL AND LOW DISPERSIBLE RADIOACTIVE MATERIAL

703. A solid material sample representing the entire contents of the *package* shall be immersed for 7 days in water at ambient temperature. The volume of water to be used in the test shall be sufficient to ensure that at the end of the 7 day test period the free volume of the unabsorbed and unreacted water remaining shall be at least

## SECTION VII

10% of the volume of the solid test sample itself. The water shall have an initial pH of 6–8 and a maximum conductivity of 1 mS/m at 20°C. The total activity of the free volume of water shall be measured following the 7 day immersion of the test sample.

### TESTS FOR SPECIAL FORM RADIOACTIVE MATERIAL

#### **General**

704. Specimens that comprise or simulate *special form radioactive material* shall be subjected to the impact test, the percussion test, the bending test, and the heat test specified in paras 705–709. A different specimen may be used for each of the tests. Following each test, a leaching assessment or volumetric leakage test shall be performed on the specimen by a method no less sensitive than the methods given in para. 710 for indispersible solid material or para. 711 for encapsulated material.

#### **Test methods**

705. Impact test: The specimen shall drop onto the target from a height of 9 m. The target shall be as defined in para. 717.

706. Percussion test: The specimen shall be placed on a sheet of lead which is supported by a smooth solid surface and struck by the flat face of a mild steel bar so as to cause an impact equivalent to that resulting from a free drop of 1.4 kg through 1 m. The lower part of the bar shall be 25 mm in diameter with the edges rounded off to a radius of  $(3.0 \pm 0.3)$  mm. The lead, of hardness number 3.5 to 4.5 on the Vickers scale and not more than 25 mm thick, shall cover an area greater than that covered by the specimen. A fresh surface of lead shall be used for each impact. The bar shall strike the specimen so as to cause maximum damage.

707. Bending test: The test shall apply only to long, slender sources with both a minimum length of 10 cm and a length to minimum width ratio of not less than 10. The specimen shall be rigidly clamped in a horizontal position so that one half of its length protrudes from the face of the clamp. The orientation of the specimen shall be such that the specimen will suffer maximum damage when its free end is struck by the flat face of a steel bar. The bar shall strike the specimen so as to cause an impact equivalent to that resulting from a free vertical drop of 1.4 kg through 1 m. The lower part of the bar shall be 25 mm in diameter with the edges rounded off to a radius of  $(3.0 \pm 0.3)$  mm.



## TEST PROCEDURES

708. Heat test: The specimen shall be heated in air to a temperature of 800°C and held at that temperature for a period of 10 minutes and shall then be allowed to cool.

709. Specimens that comprise or simulate *radioactive material* enclosed in a sealed capsule may be excepted from:

- (a) The tests prescribed in paras 705 and 706 provided the mass of the *special form radioactive material* is less than 200 g and they are alternatively subjected to the Class 4 impact test prescribed in the International Organization for Standardization document ISO 2919: “Sealed Radioactive Sources — Classification” [11], and
- (b) The test prescribed in para. 708 provided they are alternatively subjected to the Class 6 temperature test specified in the International Organization for Standardization document ISO 2919: “Sealed Radioactive Sources — Classification” [11].

### **Leaching and volumetric leakage assessment methods**

710. For specimens which comprise or simulate indispersible solid material, a leaching assessment shall be performed as follows:

- (a) The specimen shall be immersed for 7 days in water at ambient temperature. The volume of water to be used in the test shall be sufficient to ensure that at the end of the 7 day test period the free volume of the unabsorbed and unreacted water remaining shall be at least 10% of the volume of the solid test sample itself. The water shall have an initial pH of 6–8 and a maximum conductivity of 1 mS/m at 20°C.
- (b) The water with specimen shall then be heated to a temperature of  $(50 \pm 5)^\circ\text{C}$  and maintained at this temperature for 4 hours.
- (c) The activity of the water shall then be determined.
- (d) The specimen shall then be kept for at least 7 days in still air at not less than 30°C and relative humidity not less than 90%.
- (e) The specimen shall then be immersed in water of the same specification as in (a) above and the water with the specimen heated to  $(50 \pm 5)^\circ\text{C}$  and maintained at this temperature for 4 hours.
- (f) The activity of the water shall then be determined.

711. For specimens which comprise or simulate *radioactive material* enclosed in a sealed capsule, either a leaching assessment or a volumetric leakage assessment shall be performed as follows:

## SECTION VII

- (a) The leaching assessment shall consist of the following steps:
  - (i) The specimen shall be immersed in water at ambient temperature. The water shall have an initial pH of 6–8 with a maximum conductivity of 1 mS/m at 20°C.
  - (ii) The water and specimen shall be heated to a temperature of  $(50 \pm 5)^\circ\text{C}$  and maintained at this temperature for 4 hours.
  - (iii) The activity of the water shall then be determined.
  - (iv) The specimen shall then be kept for at least 7 days in still air at not less than 30°C and relative humidity of not less than 90%.
  - (v) The process in (i), (ii) and (iii) shall be repeated.
- (b) The alternative volumetric leakage assessment shall comprise any of the tests prescribed in the International Organization for Standardization document ISO 9978: “Radiation Protection — Sealed Radioactive Sources — Leakage Test Methods” [8], which are acceptable to the *competent authority*.

### TESTS FOR LOW DISPERSIBLE RADIOACTIVE MATERIAL

712. A specimen that comprises or simulates *low dispersible radioactive material* shall be subjected to the enhanced thermal test specified in para. 736 and the impact test specified in para. 737. A different specimen may be used for each of the tests. Following each test, the specimen shall be subjected to the leach test specified in para. 703. After each test it shall be determined if the applicable requirements of para. 605 have been met.

### TESTS FOR PACKAGES

#### **Preparation of a specimen for testing**

713. All specimens shall be inspected before testing in order to identify and record faults or damage including the following:

- (a) divergence from the *design*;
- (b) defects in manufacture;
- (c) corrosion or other deterioration; and
- (d) distortion of features.

714. The *containment system* of the *package* shall be clearly specified.

## TEST PROCEDURES

715. The external features of the specimen shall be clearly identified so that reference may be made simply and clearly to any part of such specimen.

### **Testing the integrity of the containment system and shielding and assessing criticality safety**

716. After each of the applicable tests specified in paras 718–737:

- (a) Faults and damage shall be identified and recorded;
- (b) It shall be determined whether the integrity of the *containment system* and shielding has been retained to the extent required in Section VI for the *package* under test; and
- (c) For *packages* containing *fissile material*, it shall be determined whether the assumptions and conditions used in the assessments required by paras 671–682 for one or more *packages* are valid.

### **Target for drop tests**

717. The target for the drop test specified in paras 705, 722, 725(a), 727 and 735 shall be a flat, horizontal surface of such a character that any increase in its resistance to displacement or deformation upon impact by the specimen would not significantly increase damage to the specimen.

### **Test for packagings designed to contain uranium hexafluoride**

718. Specimens that comprise or simulate *packagings* designed to contain 0.1 kg or more of uranium hexafluoride shall be tested hydraulically at an internal pressure of at least 1.38 MPa but, when the test pressure is less than 2.76 MPa, the *design* shall require *multilateral approval*. For retesting *packagings*, any other equivalent non-destructive testing may be applied subject to *multilateral approval*.

### **Tests for demonstrating ability to withstand normal conditions of transport**

719. The tests are: the water spray test, the free drop test, the stacking test and the penetration test. Specimens of the *package* shall be subjected to the free drop test, the stacking test and the penetration test, preceded in each case by the water spray test. One specimen may be used for all the tests, provided that the requirements of para. 720 are fulfilled.

720. The time interval between the conclusion of the water spray test and the succeeding test shall be such that the water has soaked in to the maximum extent,

## SECTION VII

without appreciable drying of the exterior of the specimen. In the absence of any evidence to the contrary, this interval shall be taken to be two hours if the water spray is applied from four directions simultaneously. No time interval shall elapse, however, if the water spray is applied from each of the four directions consecutively.

721. Water spray test: The specimen shall be subjected to a water spray test that simulates exposure to rainfall of approximately 5 cm per hour for at least one hour.

722. Free drop test: The specimen shall drop onto the target so as to suffer maximum damage in respect of the safety features to be tested.

- (a) The height of drop measured from the lowest point of the specimen to the upper surface of the target shall be not less than the distance specified in Table XIII for the applicable mass. The target shall be as defined in para. 717.
- (b) For rectangular fibreboard or wood *packages* not exceeding a mass of 50 kg, a separate specimen shall be subjected to a free drop onto each corner from a height of 0.3 m.
- (c) For cylindrical fibreboard *packages* not exceeding a mass of 100 kg, a separate specimen shall be subjected to a free drop onto each of the quarters of each rim from a height of 0.3 m.

TABLE XIII. FREE DROP DISTANCE FOR TESTING  
PACKAGES TO NORMAL CONDITIONS OF TRANSPORT

<i>Package</i> mass (kg)	Free drop distance (m)
<i>Package</i> mass < 5 000	1.2
5 000 ≤ <i>Package</i> mass < 10 000	0.9
10 000 ≤ <i>Package</i> mass < 15 000	0.6
15 000 ≤ <i>Package</i> mass	0.3

723. Stacking test: Unless the shape of the *packaging* effectively prevents stacking, the specimen shall be subjected, for a period of 24 h, to a compressive load equal to the greater of the following:

- (a) The equivalent of 5 times the mass of the actual *package*; and
- (b) The equivalent of 13 kPa multiplied by the vertically projected area of the *package*.

The load shall be applied uniformly to two opposite sides of the specimen, one of which shall be the base on which the *package* would typically rest.

## TEST PROCEDURES

724. Penetration test: The specimen shall be placed on a rigid, flat, horizontal surface which will not move significantly while the test is being carried out.

- (a) A bar of 3.2 cm in diameter with a hemispherical end and a mass of 6 kg shall be dropped and directed to fall, with its longitudinal axis vertical, onto the centre of the weakest part of the specimen, so that, if it penetrates sufficiently far, it will hit the *containment system*. The bar shall not be significantly deformed by the test performance.
- (b) The height of drop of the bar measured from its lower end to the intended point of impact on the upper surface of the specimen shall be 1 m.

### **Additional tests for Type A packages designed for liquids and gases**

725. A specimen or separate specimens shall be subjected to each of the following tests unless it can be demonstrated that one test is more severe for the specimen in question than the other, in which case one specimen shall be subjected to the more severe test.

- (a) Free drop test: The specimen shall drop onto the target so as to suffer the maximum damage in respect of containment. The height of the drop measured from the lowest part of the specimen to the upper surface of the target shall be 9 m. The target shall be as defined in para. 717.
- (b) Penetration test: The specimen shall be subjected to the test specified in para. 724 except that the height of drop shall be increased to 1.7 m from the 1 m specified in para. 724(b).

### **Tests for demonstrating ability to withstand accident conditions of transport**

726. The specimen shall be subjected to the cumulative effects of the tests specified in para. 727 and para. 728, in that order. Following these tests, either this specimen or a separate specimen shall be subjected to the effect(s) of the water immersion test(s) as specified in para. 729 and, if applicable, para. 730.

727. Mechanical test: The mechanical test consists of three different drop tests. Each specimen shall be subjected to the applicable drops as specified in para. 656 or para. 682. The order in which the specimen is subjected to the drops shall be such that, on completion of the mechanical test, the specimen shall have suffered such damage as will lead to the maximum damage in the thermal test which follows.

- (a) For drop I, the specimen shall drop onto the target so as to suffer the maximum damage, and the height of the drop measured from the lowest point of the

## SECTION VII

specimen to the upper surface of the target shall be 9 m. The target shall be as defined in para. 17.

- (b) For drop II, the specimen shall drop so as to suffer the maximum damage onto a bar rigidly mounted perpendicularly on the target. The height of the drop measured from the intended point of impact of the specimen to the upper surface of the bar shall be 1 m. The bar shall be of solid mild steel of circular section,  $(15.0 \pm 0.5)$  cm in diameter and 20 cm long unless a longer bar would cause greater damage, in which case a bar of sufficient length to cause maximum damage shall be used. The upper end of the bar shall be flat and horizontal with its edge rounded off to a radius of not more than 6 mm. The target on which the bar is mounted shall be as described in para. 717.
- (c) For drop III, the specimen shall be subjected to a dynamic crush test by positioning the specimen on the target so as to suffer maximum damage by the drop of a 500 kg mass from 9 m onto the specimen. The mass shall consist of a solid mild steel plate 1 m by 1 m and shall fall in a horizontal attitude. The height of the drop shall be measured from the underside of the plate to the highest point of the specimen. The target on which the specimen rests shall be as defined in para. 717.

728. Thermal test: The specimen shall be in thermal equilibrium under conditions of an ambient temperature of 38°C, subject to the solar insolation conditions specified in Table XI and subject to the design maximum rate of internal heat generation within the *package* from the *radioactive contents*. Alternatively, any of these parameters are allowed to have different values prior to and during the test, providing due account is taken of them in the subsequent assessment of *package* response.

The thermal test shall then consist of:

- (a) Exposure of a specimen for a period of 30 minutes to a thermal environment which provides a heat flux at least equivalent to that of a hydrocarbon fuel/air fire in sufficiently quiescent ambient conditions to give a minimum average flame emissivity coefficient of 0.9 and an average temperature of at least 800°C, fully engulfing the specimen, with a surface absorptivity coefficient of 0.8 or that value which the *package* may be demonstrated to possess if exposed to the fire specified, followed by;
- (b) Exposure of the specimen to an ambient temperature of 38°C, subject to the solar insolation conditions specified in Table XI and subject to the design maximum rate of internal heat generation within the *package* by the *radioactive contents* for a sufficient period to ensure that temperatures in the specimen are everywhere decreasing and/or are approaching initial steady state conditions. Alternatively, any of these parameters are allowed to have different values

## TEST PROCEDURES

following cessation of heating, providing due account is taken of them in the subsequent assessment of *package* response.

During and following the test the specimen shall not be artificially cooled and any combustion of materials of the specimen shall be permitted to proceed naturally.

729. Water immersion test: The specimen shall be immersed under a head of water of at least 15 m for a period of not less than eight hours in the attitude which will lead to maximum damage. For demonstration purposes, an external gauge pressure of at least 150 kPa shall be considered to meet these conditions.

### **Enhanced water immersion test for Type B(U) and Type B(M) packages containing more than $10^5$ A<sub>2</sub> and Type C packages**

730. Enhanced water immersion test: The specimen shall be immersed under a head of water of at least 200 m for a period of not less than one hour. For demonstration purposes, an external gauge pressure of at least 2 MPa shall be considered to meet these conditions.

### **Water leakage test for packages containing fissile material**

731. *Packages* for which water in-leakage or out-leakage to the extent which results in greatest reactivity has been assumed for purposes of assessment under paras 677–682 shall be excepted from the test.

732. Before the specimen is subjected to the water leakage test specified below, it shall be subjected to the tests in para. 727(b), and either para. 727(a) or (c) as required by para. 682, and the test specified in para. 728.

733. The specimen shall be immersed under a head of water of at least 0.9 m for a period of not less than eight hours and in the attitude for which maximum leakage is expected.

### **Tests for Type C packages**

734. Specimens shall be subjected to the effects of each of the following test sequences in the orders specified:

- (a) the tests specified in paras 727(a), 727(c), 735 and 736; and
- (b) the test specified in para. 737.

Separate specimens are allowed to be used for each of the sequences (a) and (b).

## SECTION VII

735. Puncture/tearing test: The specimen shall be subjected to the damaging effects of a solid probe made of mild steel. The orientation of the probe to the surface of the specimen shall be such as to cause maximum damage at the conclusion of the test sequence specified in para. 734(a).

- (a) The specimen, representing a *package* having a mass less than 250 kg, shall be placed on a target and subjected to a probe having a mass of 250 kg falling from a height of 3 m above the intended impact point. For this test the probe shall be a 20 cm diameter cylindrical bar with the striking end forming a frustum of a right circular cone with the following dimensions: 30 cm height and 2.5 cm diameter at the top with its edge rounded off to a radius of not more than 6 mm. The target on which the specimen is placed shall be as specified in para. 717.
- (b) For *packages* having a mass of 250 kg or more, the base of the probe shall be placed on a target and the specimen dropped onto the probe. The height of the drop, measured from the point of impact with the specimen to the upper surface of the probe shall be 3 m. For this test the probe shall have the same properties and dimensions as specified in (a) above, except that the length and mass of the probe shall be such as to incur maximum damage to the specimen. The target on which the base of the probe is placed shall be as specified in para. 717.

736. Enhanced thermal test: The conditions for this test shall be as specified in para. 728, except that the exposure to the thermal environment shall be for a period of 60 minutes.

737. Impact test: The specimen shall be subject to an impact on a target at a velocity of not less than 90 m/s, at such an orientation as to suffer maximum damage. The target shall be as defined in para. 717, except that the target surface may be at any orientation as long as the surface is normal to the specimen path.



## Section VIII

### APPROVAL AND ADMINISTRATIVE REQUIREMENTS

#### GENERAL

801. For *package designs* where it is not required that a *competent authority* issue an approval certificate the *consignor* shall, on request, make available for inspection by the relevant *competent authority*, documentary evidence of the compliance of the *package design* with all the applicable requirements.

802. *Competent authority* approval shall be required for the following:

- (a) *designs* for
  - (i) *special form radioactive material* (see paras 803, 804 and 818);
  - (ii) *low dispersible radioactive material* (see paras 803 and 804);
  - (iii) *packages* containing 0.1 kg or more of uranium hexafluoride (see para. 5);
  - (iv) all *packages* containing *fissile material* unless excepted by para. 672 (see paras 812–814, 816 and 817);
  - (v) *Type B(U) packages* and *Type B(M) packages* (see paras 806–811, 816 and 817);
  - (vi) *Type C packages* (see paras 806–808);
- (b) *special arrangements* (see paras 824–826);
- (c) certain *shipments* (see paras 820–823);
- (d) *radiation protection programme* for special use *vessels* (see para. 575(a)); and
- (e) calculation of radionuclide values that are not listed in Table I (see para. 402).

#### APPROVAL OF SPECIAL FORM RADIOACTIVE MATERIAL AND LOW DISPERSIBLE RADIOACTIVE MATERIAL

803. The *design* for *special form radioactive material* shall require *unilateral approval*. The *design* for *low dispersible radioactive material* shall require *multi-lateral approval*. In both cases, an application for approval shall include:

- (a) a detailed description of the *radioactive material* or, if a capsule, the contents; particular reference shall be made to both physical and chemical states;
- (b) a detailed statement of the *design* of any capsule to be used;

## SECTION VIII

- (c) a statement of the tests which have been done and their results, or evidence based on calculative methods to show that the *radioactive material* is capable of meeting the performance standards, or other evidence that the *special form radioactive material* or *low dispersible radioactive material* meets the applicable requirements of these Regulations;
- (d) a specification of the applicable *quality assurance* programme as required in para. 310; and
- (e) any proposed pre-shipment actions for use in the *consignment* of *special form radioactive material* or *low dispersible radioactive material*.

804. The *competent authority* shall establish an approval certificate stating that the approved *design* meets the requirements for *special form radioactive material* or *low dispersible radioactive material* and shall attribute to that *design* an identification mark.

### APPROVAL OF PACKAGE DESIGNS

#### **Approval of package designs to contain uranium hexafluoride**

805. The approval of *designs* for *packages* containing 0.1 kg or more of uranium hexafluoride requires that:

- (a) After 31 December 2000, each *design* that meets the requirements of para. 632 shall require *multilateral approval*. After 31 December 2003, each *design* that meets the requirements of paras 629–631 shall require *unilateral approval* by the *competent authority* of the country of origin of the *design*;
- (b) The application for approval shall include all information necessary to satisfy the *competent authority* that the *design* meets the requirements of para. 629, and a specification of the applicable *quality assurance* programme as required in para. 310;
- (c) The *competent authority* shall establish an approval certificate stating that the approved *design* meets the requirements of para. 629 and shall attribute to that *design* an identification mark.

#### **Approval of Type B(U) and Type C package designs**

806. Each *Type B(U)* and *Type C package design* shall require *unilateral approval*, except that:

- (a) a *package design* for *fissile material*, which is also subject to paras 812–814, shall require *multilateral approval*; and

## APPROVAL AND ADMINISTRATIVE REQUIREMENTS

- (b) a *Type B(U) package design* for *low dispersible radioactive material* shall require *multilateral approval*.

807. An application for approval shall include:

- (a) a detailed description of the proposed *radioactive contents* with reference to their physical and chemical states and the nature of the radiation emitted;
- (b) a detailed statement of the *design*, including complete engineering drawings and schedules of materials and methods of manufacture;
- (c) a statement of the tests which have been done and their results, or evidence based on calculative methods or other evidence that the *design* is adequate to meet the applicable requirements;
- (d) the proposed operating and maintenance instructions for the use of the *packaging*;
- (e) if the *package* is designed to have a *maximum normal operating pressure* in excess of 100 kPa gauge, a specification of the materials of manufacture of the *containment system*, the samples to be taken, and the tests to be made;
- (f) where the proposed *radioactive contents* are irradiated fuel, the applicant shall state and justify any assumption in the safety analysis relating to the characteristics of the fuel and describe any pre-shipment measurement required by para. 674(b);
- (g) any special stowage provisions necessary to ensure the safe dissipation of heat from the *package* considering the various modes of transport to be used and type of *conveyance* or *freight container*;
- (h) a reproducible illustration, not larger than 21 cm by 30 cm, showing the make-up of the *package*; and
- (i) a specification of the applicable *quality assurance* programme as required in para. 310.

808. The *competent authority* shall establish an approval certificate stating that the approved *design* meets the requirements for *Type B(U)* or *Type C packages* and shall attribute to that *design* an identification mark.

### Approval of Type B(M) package designs

809. Each *Type B(M) package design*, including those for *fissile material* which are also subject to paras 812–814 and those for *low dispersible radioactive material*, shall require *multilateral approval*.

810. An application for approval of a *Type B(M) package design* shall include, in addition to the information required in para. 807 for *Type B(U) packages*:

## SECTION VIII

- (a) a list of the requirements specified in paras 637, 653, 654 and 657–664 with which the *package* does not conform;
- (b) any proposed supplementary operational controls to be applied during transport not regularly provided for in these Regulations, but which are necessary to ensure the safety of the *package* or to compensate for the deficiencies listed in (a) above;
- (c) a statement relative to any restrictions on the mode of transport and to any special loading, carriage, unloading or handling procedures; and
- (d) the range of ambient conditions (temperature, solar radiation) which are expected to be encountered during transport and which have been taken into account in the *design*.

811. The *competent authority* shall establish an approval certificate stating that the approved *design* meets the applicable requirements for *Type B(M) packages* and shall attribute to that design an identification mark.

### **Approval of package designs to contain fissile material**

812. Each *package design* for *fissile material* which is not excepted according to para. 672 from the requirements that apply specifically to *packages* containing *fissile material* shall require *multilateral approval*.

813. An application for approval shall include all information necessary to satisfy the *competent authority* that the *design* meets the requirements of para. 671, and a specification of the applicable *quality assurance* programme as required in para. 310.

814. The *competent authority* shall establish an approval certificate stating that the approved *design* meets the requirements of para. 671 and shall attribute to that design an identification mark.

## TRANSITIONAL ARRANGEMENTS

### **Packages not requiring competent authority approval of design under the 1985 and 1985 (As Amended 1990) Editions of these Regulations**

815. *Excepted packages*, *Type IP-1*, *Type IP-2* and *Type IP-3* and *Type A packages* that did not require *approval of design* by the *competent authority* and which meet the requirements of the 1985 or 1985 (As Amended 1990) Editions of these Regulations may continue to be used subject to the mandatory programme of *quality assurance* in accordance with the requirements of para. 310 and the activity limits and

## APPROVAL AND ADMINISTRATIVE REQUIREMENTS

material restrictions of Section IV. Any *packaging* modified, unless to improve safety, or manufactured after 31 December 2003, shall meet this Edition of the Regulations in full. *Packages* prepared for transport not later than 31 December 2003 under the 1985 or 1985 (As Amended 1990) Editions of these Regulations may continue in transport. *Packages* prepared for transport after this date shall meet this Edition of the Regulations in full.

### **Packages approved under the 1973, 1973 (As Amended), 1985 and 1985 (As Amended 1990) Editions of these Regulations**

816. *Packagings* manufactured to a *package design* approved by the *competent authority* under the provisions of the 1973 or 1973 (As Amended) Editions of these Regulations may continue to be used, subject to: *multilateral approval* of *package design*, the mandatory programme of *quality assurance* in accordance with the applicable requirements of para. 310; the activity limits and material restrictions of Section IV; and, for a *package* containing *fissile material* and transported by air, the requirement of para. 680. No new manufacture of such *packaging* shall be permitted to commence. Changes in the *design* of the *packaging* or in the nature or quantity of the authorized *radioactive contents* which, as determined by the *competent authority*, would significantly affect safety shall require that this Edition of the Regulations be met in full. A serial number according to the provision of para. 538 shall be assigned to and marked on the outside of each *packaging*.

817. *Packagings* manufactured to a *package design* approved by the *competent authority* under the provisions of the 1985 or 1985 (As Amended 1990) Editions of these Regulations may continue to be used until 31 December 2003, subject to: the mandatory programme of *quality assurance* in accordance with the requirements of para. 310; the activity limits and material restrictions of Section IV; and, for a *package* containing *fissile material* and transported by air, the requirement of para. 680. After this date use may continue subject, additionally, to *multilateral approval* of *package design*. Changes in the *design* of the *packaging* or in the nature or quantity of the authorized *radioactive contents* which, as determined by the *competent authority*, would significantly affect safety shall require that this Edition of the Regulations be met in full. All *packagings* for which manufacture begins after 31 December 2006 shall meet this Edition of the Regulations in full.

### **Special form radioactive material approved under the 1973, 1973 (As Amended), 1985 and 1985 (As Amended 1990) Editions of these Regulations**

818. *Special form radioactive material* manufactured to a *design* which had received *unilateral approval* by the *competent authority* under the 1973, 1973 (As Amended),

## SECTION VIII

1985 or 1985 (As Amended 1990) Editions of these Regulations may continue to be used when in compliance with the mandatory programme of *quality assurance* in accordance with the applicable requirements of para. 310. All *special form radioactive material* manufactured after 31 December 2003 shall meet this Edition of the Regulations in full.

### NOTIFICATION AND REGISTRATION OF SERIAL NUMBERS

819. The *competent authority* shall be informed of the serial number of each *packaging* manufactured to a *design* approved under paras 806, 809, 812, and 816–817. The *competent authority* should, consistent with para. 311, maintain a register of such serial numbers.

### APPROVAL OF SHIPMENTS

820. *Multilateral approval* shall be required for:

- (a) the *shipment* of *Type B(M) packages* not conforming with the requirements of para. 637 or designed to allow controlled intermittent venting;
- (b) the *shipment* of *Type B(M) packages* containing *radioactive material* with an activity greater than 3000  $A_1$  or 3000  $A_2$ , as appropriate, or 1000 TBq, whichever is the lower;
- (c) the *shipment* of *packages* containing *fissile materials* if the sum of the *criticality safety indexes* of the *packages* exceeds 50; and
- (d) *radiation protection programmes* for *shipments* by special use *vessels* according to para. 575(a).

821. A *competent authority* may authorize transport into or through its country without *shipment* approval, by a specific provision in its *design* approval (see para. 827).

822. An application for *shipment* approval shall include:

- (a) the period of time, related to the *shipment*, for which the approval is sought;
- (b) the actual *radioactive contents*, the expected modes of transport, the type of *conveyance*, and the probable or proposed route; and
- (c) the details of how the precautions and administrative or operational controls, referred to in the *package design* approval certificates issued under paras 808, 811 and 814, are to be put into effect.

## APPROVAL AND ADMINISTRATIVE REQUIREMENTS

823. Upon approval of the *shipment*, the *competent authority* shall issue an approval certificate.

### APPROVAL OF SHIPMENTS UNDER SPECIAL ARRANGEMENT

824. Each *consignment* transported internationally under *special arrangement* shall require *multilateral approval*.

825. An application for approval of *shipments* under *special arrangement* shall include all the information necessary to satisfy the *competent authority* that the overall level of safety in transport is at least equivalent to that which would be provided if all the applicable requirements of these Regulations had been met. The application shall also include:

- (a) A statement of the respects in which, and of the reasons why, the *consignment* cannot be made in full accordance with the applicable requirements; and
- (b) A statement of any special precautions or special administrative or operational controls which are to be employed during transport to compensate for the failure to meet the applicable requirements.

826. Upon approval of *shipments* under *special arrangement*, the *competent authority* shall issue an approval certificate.

### COMPETENT AUTHORITY APPROVAL CERTIFICATES

827. Five types of approval certificates may be issued: *special form radioactive material*, *low dispersible radioactive material*, *special arrangement*, *shipment* and *package design*. The *package design* and *shipment* approval certificates may be combined into a single certificate.

#### **Competent authority identification marks**

828. Each approval certificate issued by a *competent authority* shall be assigned an identification mark. The mark shall be of the following generalized type:

VRI/Number/Type Code

- (a) Except as provided in para. 829(b), VRI represents the international *vehicle* registration identification code of the country issuing the certificate.

## SECTION VIII

- (b) The number shall be assigned by the *competent authority*, and shall be unique and specific with regard to the particular *design* or *shipment*. The *shipment* approval identification mark shall be clearly related to the *design* approval identification mark.
- (c) The following type codes shall be used in the order listed to indicate the types of approval certificates issued:

AF	<i>Type A package design for fissile material</i>
B(U)	<i>Type B(U) package design [B(U)F if for fissile material]</i>
B(M)	<i>Type B(M) package design [B(M)F if for fissile material]</i>
C	<i>Type C package design [CF if for fissile material]</i>
IF	<i>Industrial package design for fissile material</i>
S	<i>Special form radioactive material</i>
LD	<i>Low dispersible radioactive material</i>
T	<i>Shipment</i>
X	<i>Special arrangement.</i>

In the case of *package designs* for non-fissile or fissile excepted uranium hexafluoride, where none of the above codes apply, the following type codes shall be used;

H(U)	<i>Unilateral approval</i>
H(M)	<i>Multilateral approval</i>

- (d) For *package design* and *special form radioactive material* approval certificates, other than those issued under the provisions of paras 816–818, and for *low dispersible radioactive material* approval certificates, the symbols “-96” shall be added to the type code.

829. These type codes shall be applied as follows:

- (a) Each certificate and each *package* shall bear the appropriate identification mark, comprising the symbols prescribed in para. 828(a), (b), (c) and (d) above, except that, for *packages*, only the applicable *design* type codes including, if applicable, the symbols ‘-96’, shall appear following the second stroke, that is, the ‘T’ or ‘X’ shall not appear in the identification marking on the *package*. Where the *design* approval and *shipment* approval are combined, the applicable type codes do not need to be repeated. For example:

A/132/B(M)F-96: *A Type B(M) package design approved for fissile material, requiring multilateral approval, for which the competent authority of Austria has assigned the design number 132*



## APPROVAL AND ADMINISTRATIVE REQUIREMENTS

(to be marked on both the *package* and on the *package design* approval certificate);

A/132/B(M)F-96T: The *shipment* approval issued for a *package* bearing the identification mark elaborated above (to be marked on the certificate only);

A/137/X: A *special arrangement* approval issued by the *competent authority* of Austria, to which the number 137 has been assigned (to be marked on the certificate only);

A/139/IF-96: An *Industrial package design* for *fissile material* approved by the *competent authority* of Austria, to which *package design* number 139 has been assigned (to be marked on both the *package* and on the *package design* approval certificate); and

A/145/H(U)-96: A *package design* for fissile excepted uranium hexafluoride approved by the *competent authority* of Austria, to which *package design* number 145 has been assigned (to be marked on both the *package* and on the *package design* approval certificate).

- (b) Where *multilateral approval* is effected by validation according to para. 834, only the identification mark issued by the country of origin of the *design* or *shipment* shall be used. Where *multilateral approval* is effected by issue of certificates by successive countries, each certificate shall bear the appropriate identification mark and the *package* whose *design* was so approved shall bear all appropriate identification marks.

For example:

A/132/B(M)F-96

CH/28/B(M)F-96

would be the identification mark of a *package* which was originally approved by Austria and was subsequently approved, by separate certificate, by Switzerland. Additional identification marks would be tabulated in a similar manner on the *package*.

- (c) The revision of a certificate shall be indicated by a parenthetical expression following the identification mark on the certificate. For example,

## SECTION VIII

A/132/B(M)F-96(Rev.2) would indicate revision 2 of the Austrian *package design* approval certificate; or A/132/B(M)F-96(Rev.0) would indicate the original issuance of the Austrian *package design* approval certificate. For original issuances, the parenthetical entry is optional and other words such as 'original issuance' may also be used in place of 'Rev.0'. Certificate revision numbers may only be issued by the country issuing the original approval certificate.

- (d) Additional symbols (as may be necessitated by national requirements) may be added in brackets to the end of the identification mark; for example, A/132/B(M)F-96(SP503).
- (e) It is not necessary to alter the identification mark on the *packaging* each time that a revision to the *design* certificate is made. Such re-marking shall be required only in those cases where the revision to the *package design* certificate involves a change in the letter type codes for the *package design* following the second stroke.

### CONTENTS OF APPROVAL CERTIFICATES

#### **Special form radioactive material and low dispersible radioactive material approval certificates**

830. Each approval certificate issued by a *competent authority* for *special form radioactive material* or *low dispersible radioactive material* shall include the following information:

- (a) Type of certificate.
- (b) The *competent authority* identification mark.
- (c) The issue date and an expiry date.
- (d) List of applicable national and international regulations, including the edition of the IAEA Regulations for the Safe Transport of Radioactive Material under which the *special form radioactive material* or *low dispersible radioactive material* is approved.
- (e) The identification of the *special form radioactive material* or *low dispersible radioactive material*.
- (f) A description of the *special form radioactive material* or *low dispersible radioactive material*.
- (g) *Design* specifications for the *special form radioactive material* or *low dispersible radioactive material* which may include references to drawings.
- (h) A specification of the *radioactive contents* which includes the activities involved and which may include the physical and chemical form.

## APPROVAL AND ADMINISTRATIVE REQUIREMENTS

- (i) A specification of the applicable *quality assurance* programme as required in para. 310.
- (j) Reference to information provided by the applicant relating to specific actions to be taken prior to *shipment*.
- (k) If deemed appropriate by the *competent authority*, reference to the identity of the applicant.
- (l) Signature and identification of the certifying official.

### Special arrangement approval certificates

831. Each approval certificate issued by a *competent authority* for a *special arrangement* shall include the following information:

- (a) Type of certificate.
- (b) The *competent authority* identification mark.
- (c) The issue date and an expiry date.
- (d) Mode(s) of transport.
- (e) Any restrictions on the modes of transport, type of *conveyance*, *freight container*, and any necessary routing instructions.
- (f) List of applicable national and international regulations, including the edition of the IAEA Regulations for the Safe Transport of Radioactive Material under which the *special arrangement* is approved.
- (g) The following statement:  
“This certificate does not relieve the consignor from compliance with any requirement of the government of any country through or into which the package will be transported.”
- (h) References to certificates for alternative *radioactive contents*, other *competent authority* validation, or additional technical data or information, as deemed appropriate by the *competent authority*.
- (i) Description of the *packaging* by a reference to the drawings or a specification of the *design*. If deemed appropriate by the *competent authority*, a reproducible illustration, not larger than 21 cm by 30 cm, showing the make-up of the *package* should also be provided, accompanied by a brief description of the *packaging*, including materials of manufacture, gross mass, general outside dimensions and appearance.
- (j) A specification of the authorized *radioactive contents*, including any restrictions on the *radioactive contents* which might not be obvious from the nature of the *packaging*. This shall include the physical and chemical forms, the activities involved (including those of the various isotopes, if appropriate),

## SECTION VIII

amounts in grams (for *fissile material*), and whether *special form radioactive material* or *low dispersible radioactive material*, if applicable.

- (k) Additionally, for *packages* containing *fissile material*:
  - (i) a detailed description of the authorized *radioactive contents*;
  - (ii) the value of the *criticality safety index*;
  - (iii) reference to the documentation that demonstrates the criticality safety of the contents;
  - (iv) any special features, on the basis of which the absence of water from certain void spaces has been assumed in the criticality assessment;
  - (v) any allowance (based on para. 674(b)) for a change in neutron multiplication assumed in the criticality assessment as a result of actual irradiation experience; and
  - (vi) the ambient temperature range for which the *special arrangement* has been approved.
- (l) A detailed listing of any supplementary operational controls required for preparation, loading, carriage, unloading and handling of the *consignment*, including any special stowage provisions for the safe dissipation of heat.
- (m) If deemed appropriate by the *competent authority*, reasons for the *special arrangement*.
- (n) Description of the compensatory measures to be applied as a result of the *shipment* being under *special arrangement*.
- (o) Reference to information provided by the applicant relating to the use of the *packaging* or specific actions to be taken prior to the *shipment*.
- (p) A statement regarding the ambient conditions assumed for purposes of *design* if these are not in accordance with those specified in paras 653, 654 and 664, as applicable.
- (q) Any emergency arrangements deemed necessary by the *competent authority*.
- (r) A specification of the applicable *quality assurance* programme as required in para. 310.
- (s) If deemed appropriate by the *competent authority*, reference to the identity of the applicant and to the identity of the *carrier*.
- (t) Signature and identification of the certifying official.

### Shipment approval certificates

832. Each approval certificate for a *shipment* issued by a *competent authority* shall include the following information:

- (a) Type of certificate.
- (b) The *competent authority* identification mark(s).
- (c) The issue date and an expiry date.

## APPROVAL AND ADMINISTRATIVE REQUIREMENTS

- (d) List of applicable national and international regulations, including the edition of the IAEA Regulations for the Safe Transport of Radioactive Material under which the *shipment* is approved.
- (e) Any restrictions on the modes of transport, type of *conveyance*, *freight container*, and any necessary routing instructions.
- (f) The following statement:  
“This certificate does not relieve the consignor from compliance with any requirement of the government of any country through or into which the package will be transported.”
- (g) A detailed listing of any supplementary operational controls required for preparation, loading, carriage, unloading and handling of the *consignment*, including any special stowage provisions for the safe dissipation of heat or maintenance of criticality safety.
- (h) Reference to information provided by the applicant relating to specific actions to be taken prior to *shipment*.
- (i) Reference to the applicable *design* approval certificate(s).
- (j) A specification of the actual *radioactive contents*, including any restrictions on the *radioactive contents* which might not be obvious from the nature of the *packaging*. This shall include the physical and chemical forms, the total activities involved (including those of the various isotopes, if appropriate), amounts in grams (for *fissile material*), and whether *special form radioactive material* or *low dispersible radioactive material*, if applicable .
- (k) Any emergency arrangements deemed necessary by the *competent authority*.
- (l) A specification of the applicable *quality assurance* programme as required in para. 310.
- (m) If deemed appropriate by the *competent authority*, reference to the identity of the applicant.
- (n) Signature and identification of the certifying official.

### Package design approval certificates

833. Each approval certificate of the *design* of a *package* issued by a *competent authority* shall include the following information:

- (a) Type of certificate.
- (b) The *competent authority* identification mark.
- (c) The issue date and an expiry date.
- (d) Any restriction on the modes of transport, if appropriate.

## SECTION VIII

- (e) List of applicable national and international regulations, including the edition of the IAEA Regulations for the Safe Transport of Radioactive Material under which the *design* is approved.
- (f) The following statement:  
“This certificate does not relieve the consignor from compliance with any requirement of the government of any country through or into which the package will be transported.”
- (g) References to certificates for alternative *radioactive contents*, other *competent authority* validation, or additional technical data or information, as deemed appropriate by the *competent authority*.
- (h) A statement authorizing *shipment* where *shipment* approval is required under para. 820, if deemed appropriate.
- (i) Identification of the *packaging*.
- (j) Description of the *packaging* by a reference to the drawings or specification of the *design*. If deemed appropriate by the *competent authority*, a reproducible illustration, not larger than 21 cm by 30 cm, showing the make-up of the *package* should also be provided, accompanied by a brief description of the *packaging*, including materials of manufacture, gross mass, general outside dimensions and appearance.
- (k) Specification of the *design* by reference to the drawings.
- (l) A specification of the authorized *radioactive content*, including any restrictions on the *radioactive contents* which might not be obvious from the nature of the *packaging*. This shall include the physical and chemical forms, the activities involved (including those of the various isotopes, if appropriate), amounts in grams (for *fissile material*), and whether *special form radioactive material* or *low dispersible radioactive material*, if applicable.
- (m) Additionally, for *packages* containing *fissile material*:
  - (i) a detailed description of the authorized *radioactive contents*;
  - (ii) the value of the *criticality safety index*;
  - (iii) reference to the documentation that demonstrates the criticality safety of the contents;
  - (iv) any special features, on the basis of which the absence of water from certain void spaces has been assumed in the criticality assessment;
  - (v) any allowance (based on para. 674(b)) for a change in neutron multiplication assumed in the criticality assessment as a result of actual irradiation experience; and
  - (vi) the ambient temperature range for which the *package design* has been approved.
- (n) For *Type B(M) packages*, a statement specifying those prescriptions of paras 637, 653, 654 and 657–664 with which the *package* does not conform and any amplifying information which may be useful to other *competent authorities*.

## APPROVAL AND ADMINISTRATIVE REQUIREMENTS

- (o) A detailed listing of any supplementary operational controls required for preparation, loading, carriage, unloading and handling of the *consignment*, including any special stowage provisions for the safe dissipation of heat.
- (p) Reference to information provided by the applicant relating to the use of the *packaging* or specific actions to be taken prior to *shipment*.
- (q) A statement regarding the ambient conditions assumed for purposes of *design* if these are not in accordance with those specified in paras 653, 654 and 664, as applicable.
- (r) A specification of the applicable *quality assurance* programme as required in para. 310.
- (s) Any emergency arrangements deemed necessary by the *competent authority*.
- (t) If deemed appropriate by the *competent authority*, reference to the identity of the applicant.
- (u) Signature and identification of the certifying official.

## VALIDATION OF CERTIFICATES

834. *Multilateral approval* may be by validation of the original certificate issued by the *competent authority* of the country of origin of the *design* or *shipment*. Such validation may take the form of an endorsement on the original certificate or the issuance of a separate endorsement, annex, supplement, etc., by the *competent authority* of the country through or into which the *shipment* is made.

## REFERENCES

The editions of the publications cited as references in these Regulations are current at the time of publication. The most recent editions should be consulted in *defining requirements* established in these Regulations.

- [1] INTERNATIONAL ATOMIC ENERGY AGENCY, Radiation Protection and the Safety of Radiation Sources, Safety Series No. 120, IAEA, Vienna (1996).
- [2] FOOD AND AGRICULTURE ORGANIZATION OF THE UNITED NATIONS, INTERNATIONAL ATOMIC ENERGY AGENCY, INTERNATIONAL LABOUR ORGANISATION, OECD NUCLEAR ENERGY AGENCY, PAN AMERICAN HEALTH ORGANIZATION, WORLD HEALTH ORGANIZATION, International Basic Safety Standards for Protection against Ionizing Radiation and for the Safety of Radiation Sources, Safety Series No. 115, IAEA, Vienna (1996).
- [3] INTERNATIONAL ATOMIC ENERGY AGENCY, Advisory Material for the IAEA Regulations for the Safe Transport of Radioactive Material (1996 Edition), Safety Standards Series No. TS-G-1.1 (ST-2), IAEA, Vienna (2002).
- [4] INTERNATIONAL ATOMIC ENERGY AGENCY, Planning and Preparing for Emergency Response to Transport Accidents Involving Radioactive Material, Safety Standards Series No. TS-G-1.2 (ST-3), IAEA, Vienna (2002).
- [5] INTERNATIONAL ATOMIC ENERGY AGENCY, Compliance Assurance for the Safe Transport of Radioactive Material, Safety Standards Series No. TS-G-1.4, IAEA, Vienna (in preparation).
- [6] INTERNATIONAL ATOMIC ENERGY AGENCY, Quality Assurance for the Safe Transport of Radioactive Material, Safety Standards Series No. TS-G-1.3, IAEA, Vienna (in preparation).
- [7] UNITED NATIONS, Recommendations on the Transport of Dangerous Goods, Ninth Revised Edition (ST/SG/AC.10/1/Rev.9), UN, New York and Geneva (1995).
- [8] INTERNATIONAL ORGANIZATION FOR STANDARDIZATION, Radiation Protection — Sealed Radioactive Sources — Leakage Test Methods (ISO 9978:1992(E)), ISO, Geneva (1992).
- [9] INTERNATIONAL ORGANIZATION FOR STANDARDIZATION, Series 1 Freight Containers — Specifications and Testing — Part 1: General Cargo Containers, (ISO 1496:1-1990(E)), ISO, Geneva (1990).
- [10] INTERNATIONAL ORGANIZATION FOR STANDARDIZATION, Packaging of Uranium Hexafluoride (UF<sub>6</sub>) for Transport (ISO 7195:1993(E)), ISO, Geneva (1993).
- [11] INTERNATIONAL ORGANIZATION FOR STANDARDIZATION, Sealed Radioactive Sources — Classification (ISO 2919:1980(E)), ISO, Geneva (1980).



# **SCHEDULES OF REQUIREMENTS FOR THE TRANSPORT OF SPECIFIED TYPES OF RADIOACTIVE MATERIAL CONSIGNMENTS**

## **PREFACE TO SCHEDULES**

These Schedules are provided as an aid to users of these Regulations. They are offered as a basic guide to national authorities and international organizations that may wish to adapt these Regulations in schedule form.

The Schedules reproduce some of the provisions of these Regulations, but do not contain any additional requirements. They simply provide a summary of the main provisions, with references being provided to the relevant detailed provisions of these Regulations to enable these to be consulted where necessary. If there are any discrepancies between these Regulations and the Schedules, the requirements in the Regulations apply.

Provisions which are common to most, but not necessarily all, of Schedules 1 to 4 are provided before these Schedules as “Common Provisions for Schedules 1–4”. Reference is made in each Schedule to these “Common Provisions” as applicable.

Similarly, provisions which are common to most, but not necessarily all, of Schedules 5 to 14 are provided before these Schedules as “Common Provisions for Schedules 5–14”. Reference is made in each Schedule to these “Common Provisions” as applicable.

## COMMON PROVISIONS FOR SCHEDULES 1–4

UN No.
<b>Refer to appropriate Schedule 1–4</b>

### A.1. MATERIALS

- 802 (a) *Competent authority approval* shall be required for the calculation of radionuclide values that are not listed in Table I. Alternatively, the radionuclide values in Table II may be used without obtaining *competent authority approval*.
- (b) The contents of uranium hexafluoride in an *excepted package* is restricted to less than 0.1 kg.

### A.2. PACKAGING/PACKAGE

- 801 (a) *Excepted packages* do not require *competent authority approval*. However, the *consignor* shall be prepared to demonstrate the compliance of the *package design* with all the applicable requirements to the relevant *competent authority*.
- 815 (b) The transitional arrangements for *excepted packages* which meet the requirements of the 1985 or 1985 (As Amended 1990) Editions of these Regulations are detailed in para. 815.

### A.3. MAXIMUM RADIATION LEVELS

- 516 5  $\mu\text{Sv/h}$  at the surface of a *package*.

### A.4. CONTAMINATION

- 508, 509 *Non-fixed contamination* on the external surfaces of *excepted packages* and on the internal and external surfaces of *overpacks, freight containers, tanks, intermediate bulk containers* and *conveyances* shall be kept as low as practicable and shall not exceed the following limits:
- (a) beta, gamma and *low toxicity alpha emitters* 4 Bq/cm<sup>2</sup>
- (b) all other alpha emitters 0.4 Bq/cm<sup>2</sup>

## SCHEDULES 1-4

### A.5. DECONTAMINATION

- 512 (a) A *conveyance* and equipment used regularly for the transport of *radioactive material* shall be periodically checked to determine the level of *contamination*. The frequency of such checks shall be related to the likelihood of *contamination* and the extent to which *radioactive material* is transported.
- 513 (b) *Conveyances*, equipment or parts thereof which have become contaminated above the limits specified in Common Provision A.4, or which show a surface *radiation level* in excess of 5  $\mu\text{Sv/h}$  in the course of transport of the specified type of radioactive material consignment, shall be decontaminated as soon as possible, and in any case before reuse, to levels not exceeding those specified in Common Provision A.4 and, in addition, so that the resulting surface *radiation level* after decontamination does not exceed 5  $\mu\text{Sv/h}$ .
- 504 (c) Tanks and *intermediate bulk containers* used for the transport of *radioactive material* shall not be used for storage or transport of other goods, unless decontaminated below one tenth of the levels specified in Common Provision A.4.

### A.6. MIXED CONTENTS

No specific provisions.

### A.7. LOADING AND SEGREGATION

No specific provisions.

### A.8. LABELLING AND MARKING

- 507 (a) *Packages* containing materials having additional dangerous properties shall be labelled as required by the relevant regulations.
- 536 (b) *Packages* with a gross mass exceeding 50 kg shall be legibly and durably marked on the outside of the *packaging* with their permissible gross mass.

## COMMON PROVISIONS FOR SCHEDULES 1–4

- 579 (c) For domestic *shipment* by post, applicable national regulations shall be complied with.
- 580 (d) For international *shipment* by post, each *package* shall bear:
- (i) Externally — *Consignor's* name and address and request to return if not deliverable, and the words “RADIO-ACTIVE MATERIAL — QUANTITIES PERMITTED FOR MOVEMENT BY POST”;
  - (ii) Internally — *Consignor's* name and address and contents of the *consignment*.

### A.9. PLACARDING

- 507 None required for radioactive nature of contents. Placards may be required for other dangerous properties of contents.

### A.10. TRANSPORT DOCUMENTS

See appropriate Schedule.

### A.11. STORAGE AND DISPATCH

- 579 (a) For domestic *shipment* by post, applicable national regulations shall be complied with.
- 580 (b) For international *shipment* by post, *consignors* shall be authorized by the national authority and packages shall be dispatched by the quickest route (normally by air).

### A.12. CARRIAGE

No specific provisions.

### A.13. OTHER PROVISIONS

- 109, 507 (a) Other dangerous properties of contents and transport with other dangerous goods — see paras 109 and 507.
- 301–305 (b) General provisions for radiation protection — see paras 301–305.

#### SCHEDULES 1-4

- 308, 309 (c) Accident provisions — see paras 308 and 309.
- 310 (d) *Quality assurance* — see para. 310.
- 311 (e) *Compliance assurance* — see para. 311.
- 313 (f) Non-compliance — see para. 313.
- 314–316 (g) Training — see paras 314–316.
- 511 (h) Damaged or leaking *packages* — see para. 511.
- 581 (i) Customs — see para. 581.
- 582 (j) Undeliverable *packages* — see para. 582.

## Schedule 1

### LIMITED QUANTITIES OF RADIOACTIVE MATERIAL IN EXCEPTED PACKAGES

UN No.
2910

408(b), 410, 515 Limited quantities of *radioactive material*, in forms other than manufactured instruments and articles, which represent a very limited radiological risk, may be transported in *excepted packages*.

#### 1. MATERIALS

(a) See Common Provisions A.1.

408(b), 410, Column 4 of Table III (b) Non-fissile *radioactive material* in amounts not exceeding the appropriate limits specified in Table 1.1.

408(b), 410, 672, Column 4 of Table III (c) *Fissile material* in amounts not exceeding the appropriate limits specified in Table 1.1 and, in addition, satisfying with regard to amounts, form and packaging the requirements of the Regulations allowing them to be regulated as fissile-*excepted packages*.

#### 2. PACKAGING/PACKAGE

(a) See Common Provision A.2.

515, 620 (b) The *package* shall meet the requirements specified in paras 515 and 620.

#### 3. MAXIMUM RADIATION LEVELS

See Common Provision A.3.

#### 4. CONTAMINATION

See Common Provision A.4.

**SCHEDULE 1**

TABLE 1.1. ACTIVITY LIMITS IN TERMS OF  $A_1$  AND  $A_2$  VALUES FOR EXCEPTED PACKAGES CONTAINING RADIOACTIVE MATERIAL<sup>a,b</sup>

Physical state of contents	<i>Package limits</i> (post)	<i>Package limits</i> (other modes)
Solids		
<i>special form</i>	$10^{-4} A_1$	$10^{-3} A_1$
other forms	$10^{-4} A_2$	$10^{-3} A_2$
Liquids	$10^{-5} A_2$	$10^{-4} A_2$
Gases		
tritium	$2 \times 10^{-3} A_2$	$2 \times 10^{-2} A_2$
<i>special form</i>	$10^{-4} A_1$	$10^{-3} A_1$
other forms	$10^{-4} A_2$	$10^{-3} A_2$

<sup>a</sup> For specific values of  $A_1$  and  $A_2$  see Table I and Table II.

<sup>b</sup> For mixtures of radionuclides the methods for defining  $A_1$  and  $A_2$  are provided in paras 404–406.

**5. DECONTAMINATION**

See Common Provision A.5.

**6. MIXED CONTENTS**

No specific provisions.

**7. LOADING AND SEGREGATION**

No specific provisions.

**8. LABELLING AND MARKING**

(a) See Common Provisions A.8(a) and A.8(b).

518 (b) *Packages* shall bear the marking “RADIOACTIVE” on an internal surface in such a manner that a warning of the presence of *radioactive material* is visible on opening the *package*.

## LIMITED QUANTITIES OF RADIOACTIVE MATERIAL IN EXCEPTED PACKAGES

- 534, 535 (c) All *packages* shall be legibly and durably marked on the outside of the *packaging* with an identification of either the *consignor* or *consignee*. Except for international *shipment* by post, *packages* shall bear the mark “UN 2910”.
- 579 (d) *Packages* by domestic post, in addition to 8(a)–8(c), see Common Provision A.8(c).
- 580 (e) *Packages* by international post, in addition to 8(a)–8(c), see Common Provision A.8(d).

### 9. PLACARDING

See Common Provision A.9.

### 10. TRANSPORT DOCUMENTS

- 515, 549(c) *Packages* shall be described in the transport documents as “UN 2910”.

### 11. STORAGE AND DISPATCH

- (a) By post, see Common Provision A.11.
- (b) By other modes, no specific provisions.

### 12. CARRIAGE

No specific provisions.

### 13. OTHER PROVISIONS

See Common Provision A.13.



## Schedule 2

### INSTRUMENTS OR ARTICLES IN EXCEPTED PACKAGES

UN No.
2911

Specified quantities of *radioactive material*, that are enclosed in or form a component of an instrument or other manufactured article, and which represent a very limited radiological risk, may be transported in *excepted packages*.

#### 1. MATERIALS

(a) See Common Provisions A.1.

408(a), 410, 517(a),  
Columns 2  
and 3 of  
Table III

(b) Instruments and manufactured articles such as clocks, electronic tubes or apparatus having as a component part *radioactive material* in amounts not exceeding the appropriate limits specified in Table 2.1. The *radiation level* at 10 cm from the external surface of any unpackaged instrument or article shall not exceed 0.1 mSv/h.

408(a), 410, 517(a), 672,  
Columns 2  
and 3 of  
Table III

(c) Instruments and manufactured articles containing *fissile material* in amounts not exceeding the appropriate limits specified in Table 2.1 and, in addition, satisfying with regard to amounts, form and *packaging* the requirements of the Regulations allowing them to be regulated as fissile-excepted *packages*.

#### 2. PACKAGING/PACKAGE

(a) See Common Provision A.2.

515, 620

(b) The *package* shall meet the requirements specified in paras 515 and 620.

#### 3. MAXIMUM RADIATION LEVELS

See Common Provision A.3.

## INSTRUMENTS OR ARTICLES IN EXCEPTED PACKAGES

TABLE 2.1. ACTIVITY LIMITS IN TERMS OF  $A_1$  AND  $A_2$  VALUES FOR EXCEPTED PACKAGES CONTAINING INSTRUMENTS AND ARTICLES<sup>a,b</sup>

Physical state of contents	Item limits	<i>Package</i> limits (post)	<i>Package</i> limits (other modes)
<b>Solids</b>			
<i>special form</i>	$10^{-2} A_1$	$10^{-1} A_1$	$A_1$
other forms	$10^{-2} A_2$	$10^{-1} A_2$	$A_2$
Liquids	$10^{-3} A_2$	$10^{-2} A_2$	$10^{-1} A_2$
<b>Gases</b>			
tritium	$2 \times 10^{-2} A_2$	$2 \times 10^{-2} A_2$	$2 \times 10^{-1} A_2$
<i>special form</i>	$10^{-3} A_1$	$10^{-3} A_1$	$10^{-2} A_1$
other forms	$10^{-3} A_2$	$10^{-3} A_2$	$10^{-2} A_2$

<sup>a</sup> For specific values of  $A_1$  and  $A_2$  see Table I and Table II.

<sup>b</sup> For mixtures of radionuclides the methods for defining  $A_1$  and  $A_2$  are provided in paras 404–406.

### 4. CONTAMINATION

See Common Provision A.4.

### 5. DECONTAMINATION

See Common Provision A.5.

### 6. MIXED CONTENTS

No specific provisions.

### 7. LOADING AND SEGREGATION

No specific provisions.

### 8. LABELLING AND MARKING

(a) For *packages*, see Common Provisions A.8(a) and A.8(b).

517(b) (b) Instruments, articles and consumer products: each instrument or article bears the marking “RADIOACTIVE” except:

## SCHEDULE 2

- (i) radioluminescent timepieces or devices;
- (ii) consumer products that either have received regulatory approval according to para. 107(d) or do not individually exceed the activity limit for an exempt *consignment* in Table I (column 5), provided that such products are transported in a *package* that bears the marking “RADIOACTIVE” on an internal surface in such a manner that warning of the presence of *radioactive material* is visible on opening the *package*.

- 534, 535 (c) All *packages* shall be legibly and durably marked on the outside of the *packaging* with an identification of either the *consignor* or *consignee*. Except for international *shipment* by post, *packages* shall bear the mark “UN 2911”.
- 579 (d) *Packages* by domestic post, in addition to 8(a)–8(c), see Common Provision A.8(c).
- 580 (e) *Packages* by international post, in addition to 8(a)–8(c), see Common Provision A.8(d).

### 9. PLACARDING

See Common Provision A.9.

### 10. TRANSPORT DOCUMENTS

- 515, 549(c) *Packages* shall be described in the transport documents as “UN 2911”.

### 11. STORAGE AND DISPATCH

- (a) By post, see Common Provision A.11.
- (b) By other modes, no specific provisions.

### 12. CARRIAGE

No specific provisions.

### 13. OTHER PROVISIONS

See Common Provision A.13.

### Schedule 3

## ARTICLES MANUFACTURED FROM NATURAL URANIUM, DEPLETED URANIUM OR NATURAL THORIUM AS EXCEPTED PACKAGES

UN No.
2909

409, 515, 519 Articles manufactured of *natural uranium, depleted uranium* or natural thorium, which represent a very limited radiological risk, may be transported in or as *excepted packages*.

#### 1. MATERIALS

409, 519 Manufactured articles in which the sole *radioactive material* is *natural uranium* or *depleted uranium* or natural thorium. Such articles may be unused, empty *packagings* intended for the transport of *radioactive material*.

#### 2. PACKAGING/PACKAGE

- (a) See Common Provision A.2.
- 515, 620 (b) The *package* shall meet the requirements specified in paras 515 and 620.
- 519 (c) Transport of unpackaged articles manufactured of *natural uranium, depleted uranium* or natural thorium is allowed if the article itself qualifies as an *excepted package* and the outer surface of the uranium or thorium is enclosed in an inactive sheath made of metal or some other substantial material.

#### 3. MAXIMUM RADIATION LEVELS

See Common Provision A.3.

#### 4. CONTAMINATION

See Common Provision A.4.

### SCHEDULE 3

#### 5. DECONTAMINATION

See Common Provision A.5.

#### 6. MIXED CONTENTS

No specific provisions.

#### 7. LOADING AND SEGREGATION

No specific provisions.

#### 8. LABELLING AND MARKING

(a) See Common Provisions A.8(a) and A.8(b).

534, 535 (b) All *packages* shall be legibly and durably marked on the outside of the *packaging* with an identification of either the *consignor* or *consignee*. Except for international *shipment* by post, *packages* shall bear the mark “UN 2909”.

579 (c) *Packages* by domestic post, in addition to 8(a)–8(c), see Common Provision A.8(c).

580 (d) *Packages* by international post, in addition to 8(a)–8(c), see Common Provision A.8(d).

#### 9. PLACARDING

See Common Provision A.9.

#### 10. TRANSPORT DOCUMENTS

515, 549(c) *Packages* shall be described in the transport documents as “UN 2909”.

#### 11. STORAGE AND DISPATCH

(a) By post, see Common Provision A.11.

(b) By other modes, no specific provisions.

#### 12. CARRIAGE

No specific provisions.

#### 13. OTHER PROVISIONS

See Common Provision A.13.

## Schedule 4

### EMPTY PACKAGINGS AS EXCEPTED PACKAGES

UN No.
2908

515, 520 Empty *packagings* which have contained *radioactive material* and which represent a very limited radiological risk may be transported as *excepted packages*.

#### 1. MATERIALS

520 (a) Empty *packagings* which have previously contained *radioactive material*.

520(b) (b) If the *packaging* contains any uranium or thorium in its structure the requirement specified in para. 2(d) below shall apply.

520(c) (c) The internal *non-fixed contamination* levels shall not exceed one hundred times the levels specified in Common Provision A.4.

#### 2. PACKAGING/PACKAGE

(a) See Common Provision A.2.

520, 620 (b) The *package* shall meet the requirements specified in paras 515 and 620.

520(a) (c) The *packaging* shall be in a well maintained condition and securely closed.

520(b) (d) If the empty *packaging* includes any uranium or thorium in its structure the outer surface of the uranium or thorium shall be covered with an inactive sheath made of metal or some other substantial material.

#### 3. MAXIMUM RADIATION LEVELS

See Common Provision A.3.

**SCHEDULE 4**

**4. CONTAMINATION**

See Common Provision A.4.

**5. DECONTAMINATION**

(a) See Common Provision A.5.

504 (b) In addition, an empty *tank* or *intermediate bulk container* which has been used for the transport of *radioactive material* may be transported as an *excepted package* but shall not be used for the storage or transport of other goods unless decontaminated below one tenth of the levels specified in Common Provision A.4.

**6. MIXED CONTENTS**

No specific provisions.

**7. LOADING AND SEGREGATION**

No specific provisions.

**8. LABELLING AND MARKING**

(a) See Common Provisions A.8(a) and A.8(b).

520(d), 541 (b) For all *packages*, any labels which related to the previously contained *radioactive contents* shall be removed or covered.

534, 535 (c) All *packages* shall be legibly and durably marked on the outside of the *packaging* with an identification of either the *consignor* or *consignee*. Except for international *shipment* by post, *packages* shall bear the mark “UN 2908”.

579 (d) *Packages* by domestic post, in addition to 8(a)–8(c), see Common Provision A.8(c).

580 (e) *Packages* by international post, in addition to 8(a)–8(c), see Common Provision A.8(d).

**9. PLACARDING**

See Common Provision A.9.

**EMPTY PACKAGINGS AS EXCEPTED PACKAGES**

**10. TRANSPORT DOCUMENTS**

515, 549(c) *Packages* shall be described in the transport documents as “UN 2908”.

**11. STORAGE AND DISPATCH**

- (a) By post, see Common Provision A.11.
- (b) By other modes, no specific provisions.

**12. CARRIAGE**

No specific provisions.

**13. OTHER PROVISIONS**

See Common Provision A.13.



## COMMON PROVISIONS FOR SCHEDULES 5–14

<b>UN No.</b>
<b>Refer to appropriate Schedule 5–14</b>

### B.1. MATERIALS

802 *Competent authority approval* shall be required for the calculation of radionuclide values that are not listed in Table I. Alternatively, the radionuclide values in Table II may be used without obtaining *competent authority approval*.

### B.2. PACKAGING/PACKAGE

634 (a) The smallest overall external dimension of the *package* shall not be less than 10 cm.

815 (b) The transitional arrangements for *package designs* which did not require *approval of design* by the *competent authority* and which meet the requirements of the 1985 or 1985 (As Amended 1990) Editions of these Regulations are detailed in para. 815.

816 (c) The transitional arrangements for *packagings* manufactured to a *package design* approved by the *competent authority* under the provisions of the 1973 or 1973 (As Amended) Editions of these Regulations are detailed in para. 816.

817 (d) The transitional arrangements for *packagings* manufactured to a *package design* approved by the *competent authority* under the provisions of the 1985 or 1985 (As Amended 1990) Editions of these Regulations are detailed in para. 817.

### B.3. MAXIMUM RADIATION LEVELS

526, (a) *Radiation level* limits for *packages* or *overpacks* are:  
530–532

(i) 0.1 mSv/h at 1 m from the external surfaces of the *package* or *overpack*, except when transported under *exclusive use*, and

COMMON PROVISIONS FOR SCHEDULES 5–14

- (ii) 2 mSv/h on any external surface of the *package* or *overpack*, except when transported under *exclusive use* by rail or by road, or under *exclusive use* and *special arrangement* by *vessel* or by air, and
  - (iii) 10 mSv/h on any external surface of a *package* or *overpack* transported under *exclusive use*.
  
- 572(a) (b) The *radiation levels* at any point on the external surface of *packages* or *overpacks* transported under *exclusive use* by rail or road may only exceed 2 mSv/h provided that:
  - (i) The *vehicle* is equipped with an enclosure which prevents unauthorized access during transport;
  - (ii) The *package* or *overpack* is secured to retain its position within the enclosure during routine transport; and
  - (iii) There are no loading or unloading operations between the beginning and end of the *shipment*.
  
- 572(b) (c) Surface *radiation levels* for road or rail *vehicles* under *exclusive use*, at any point on the outer surfaces of the *vehicle*, including the upper and lower surfaces, or, in the case of an open *vehicle*, at any point on the vertical planes projected from the outer edges of the *vehicle*, on the upper surface of the load, and on the lower external surface of the *vehicle* shall not exceed 2 mSv/h.
  
- 572(c) (d) *Radiation levels* for road or rail *vehicles* under *exclusive use* shall not exceed 0.1 mSv/h at any point 2 m from the vertical planes represented by the outer lateral surfaces of the *vehicle*, or, if the load is transported in an open *vehicle*, at any point 2 m from the vertical planes projected from the outer edges of the *vehicle*.
  
- 574 (e) *Packages* or *overpacks* having a surface *radiation level* greater than 2 mSv/h, unless being carried in or on a *vehicle* under *exclusive use* in accordance with Table IX, footnote (a), shall not be transported by *vessel* except under *special arrangement*.
  
- 566(c) (f) Loading of *freight containers* and the accumulation of *packages*, *overpacks* and *freight containers* aboard a single conveyance shall be such that the *radiation level* under routine conditions of transport shall not exceed 2 mSv/h at any point on, and 0.1 mSv/h at 2 m from, the external surface of the *conveyance*,

## SCHEduLES 5–14

except for *consignments* transported under *exclusive use* by road or rail, for which the radiation limits around the vehicle are set forth in para. 572(b) and (c).

- 578 (g) *Packages* or *overpacks* having a surface *radiation level* greater than 2 mSv/h shall not be transported by air except by *special arrangement*.

### B.4. CONTAMINATION

508, 509 *Non-fixed contamination* on external surfaces of *packages*, and on the internal and external surfaces of *overpacks*, *freight containers*, *tanks*, *intermediate bulk containers* and *conveyances* shall be kept as low as practicable and shall not exceed the following limits:

- (a) For beta, gamma and *low toxicity alpha emitters* 4 Bq/cm<sup>2</sup>  
(b) For all other alpha emitters 0.4 Bq/cm<sup>2</sup>

### B.5. DECONTAMINATION

- 512 (a) A *conveyance* and equipment used regularly for the transport of *radioactive material* shall be periodically checked to determine the level of *contamination*. The frequency of such checks shall be related to the likelihood of *contamination* and the extent to which *radioactive material* is transported.
- 513 (b) *Conveyances*, equipment or parts thereof which have, in the course of transport of *radioactive material*, become contaminated above the limits specified in Common Provision B.4, or which show a *radiation level* in excess of 5 µSv/h at the surface, shall be decontaminated as soon as possible by a qualified person and shall not be reused unless the *non-fixed contamination* does not exceed the limits specified in Common Provision B.4. In addition, the *radiation level* resulting from the *fixed contamination* on surfaces after decontamination shall be less than 5 µSv/h.
- 514 (c) A *freight container*, *tank*, *intermediate bulk container* or *conveyance* dedicated to the transport of unpackaged *radioactive material* under *exclusive use* shall be excepted from the requirements specified in Common Provisions B.4 and B.5(b) solely

## COMMON PROVISIONS FOR SCHEDULES 5–14

with regard to its internal surfaces and only for as long as it remains under that specific *exclusive use*.

- 504 (d) *Tanks and intermediate bulk containers* used for the transport of *radioactive material* shall not be used for storage or transport of other goods, unless decontaminated below one tenth of the levels specified in Common Provision B.4.

### B.6. MIXED CONTENTS

- 503 A *package* shall not contain any other items except such articles and documents as are necessary for the use of the *radioactive material*. The transport of such articles and documents in a *package* with other items may be permitted provided that there is no interaction between them and the *packaging* or its *radioactive contents* that would reduce the safety of the *package*.

### B.7. LOADING AND SEGREGATION

- 566(a),  
Table IX (a) Except under the condition of *exclusive use*, loading of *freight containers* and the accumulation of *packages, overpacks* and *freight containers* aboard a single *conveyance* shall be so limited that the total sum of the *transport indexes* aboard the *conveyance* does not exceed the values shown in Table IX.
- 566(b) (b) Where a *consignment* is transported under *exclusive use*, there shall be no limit on the sum of the *transport indexes* aboard a single *conveyance*.
- 566(c) (c) Loading of *freight containers* and the accumulation of *packages, overpacks* and *freight containers* aboard a single *conveyance* shall be such that the *radiation level* under routine conditions of transport shall not exceed 2 mSv/h at any point on, and 0.1 mSv/h at 2 m from, the external surface of the *conveyance*, except for *consignments* transported under *exclusive use* by road or rail, for which the radiation limits around the *vehicle* are set forth in para. 572(b) and (c).
- 505, 506 (d) *Consignments* shall be segregated from other dangerous goods during transport in compliance with the relevant transport regulations. If the *consignment* is transported under *exclusive*

## SCHEDULES 5–14

use the carriage of other goods is permitted provided the arrangements are controlled only by the *consignor* and it is not prohibited by other regulations.

- 306 (e) *Radioactive material* shall be segregated sufficiently from workers and from members of the public. The following values for dose shall be used for the purpose of calculating segregation distances or *radiation levels*:
- (i) for workers in regularly occupied working areas a dose of 5 mSv in a year;
  - (ii) for members of the public, in areas where the public has regular access, a dose of 1 mSv in a year to the critical group, taking account of exposures expected to be delivered by all other relevant sources and practices under control.
- 307 (f) *Radioactive material* shall be segregated from undeveloped photographic film so that the radiation exposure of film due to the transport of *radioactive material* is limited to 0.1 mSv per *consignment* of such film.

### **B.8. LABELLING AND MARKING**

- (a) *Packages*:
- 541 (i) For all *packages*, any labels which do not relate to the *radioactive contents* shall be removed or covered.
  - 534 (ii) Each *package* shall be legibly and durably marked on the outside of the *packaging* with an identification of either the *consignor* or *consignee*, or both.
  - 543(b) (iii) Each label shall be marked with the maximum activity of the *radioactive contents* during transport.
  - 543(d) (iv) Each YELLOW label shall be marked with the *transport index* of that *package*.
  - 536 (v) *Packages* with a gross mass exceeding 50 kg shall be durably and legibly marked with their permissible gross mass on the outside of the *packaging*.
  - 109, 507 (vi) *Packages* containing materials having additional dangerous properties (e.g. uranium hexafluoride) shall also be labelled as required by the relevant transport regulations.

## COMMON PROVISIONS FOR SCHEDULES 5–14

### (b) *Freight containers and overpacks:*

- 543(b),  
543(c) (i) Except for mixed loads, each label shall be marked with the maximum activity of the *radioactive contents* of the *freight container* or *overpack* during transport, totalled for the entire contents. For mixed loads such entries may read “See Transport Documents”.
- 543(d) (ii) Each YELLOW label shall be marked with the *transport index (TI)* for that loaded *freight container* or *overpack*.
- 109, 507 (iii) *Freight containers* and *overpacks* containing materials having additional dangerous properties (e.g. uranium hexafluoride) shall also be labelled as required by the relevant transport regulations.

### **B.9. PLACARDING**

- 546 (a) Large *freight containers* and *tanks* shall bear four placards. The placards shall be affixed in a vertical orientation to the two external side walls and the two external end walls of a *freight container* or *tank*.
- 546 (b) As an alternative to the use of placards on large *freight containers* and *tanks*, enlarged labels are permitted.
- 570(a) (c) Placards shall be affixed in a vertical orientation to the two external lateral walls of a rail *vehicle*.
- 570(b) (d) Placards shall be affixed in a vertical orientation to the two external lateral walls and the external rear wall of a road *vehicle*.
- 109, 507 (e) Placards may be required for other dangerous properties of the contents.
- 546 (f) Any placards which do not relate to the *radioactive contents* shall be removed.

### **B.10. TRANSPORT DOCUMENTS**

- (a) For a summary of the approval and notification requirements, see Annex I.

## SCHEDULES 5–14

- 549–553  
555, 556
- (b) The transport documents shall include the relevant particulars of the *consignment*, paras 549–553, and information for *carriers*, paras 555 and 556.

### B.11. STORAGE AND DISPATCH

- 306, 307  
506, 562
- (a) Segregation during storage in transit is required from other dangerous goods, and from persons and undeveloped photographic films and plates.
- 565
- (b) Provided that its average surface heat flux does not exceed 15 W/m<sup>2</sup> and that the immediately surrounding cargo is not in sacks or bags, a *package* or *overpack* may be stored among packaged general cargo without any special stowage provisions except as may be specifically required by the *competent authority* in an applicable approval certificate.

### B.12. CARRIAGE

- (a) See Common Provisions B.11(a) and (b).
- 563
- (b) Category II-YELLOW or III-YELLOW *packages* or *overpacks* shall not be carried in compartments occupied by passengers, except those exclusively reserved for couriers specially authorized to accompany such *packages* or *overpacks*.
- 567
- (c) Any *package* or *overpack* having a *transport index* greater than 10 shall be transported only under *exclusive use*.
- (d) For transport by air:
- 577
- (i) Vented Type *B(M)* *packages*, *packages* which require external cooling by an ancillary cooling system, *packages* subject to operational controls during transport and *packages* containing liquid pyrophoric materials are prohibited.
- 576
- (ii) *Type B(M)* *packages* and *consignments* under *exclusive use* are prohibited on *passenger aircraft*.
- 573
- (e) For transport by road, no persons other than the driver and assistants shall be permitted in *vehicles* carrying *packages*,

## COMMON PROVISIONS FOR SCHEDULES 5–14

*overpacks* or *freight containers* bearing category II-YELLOW or III-YELLOW labels.

- 575 (f) Transport of *consignments* by special use *vessel*, dedicated to the purpose of carrying *radioactive material*, may be excepted from the requirements specified in para. 566 provided that:
- (i) A *radiation protection programme* for the *shipment* shall be approved by the *competent authority* of the flag state of the *vessel* and, when requested, by the *competent authority* at each port of call;
  - (ii) Stowage arrangements shall be predetermined for the whole voyage including any *consignments* to be loaded at ports of call en route; and
  - (iii) The loading, carriage and the unloading of the *consignments* shall be supervised by persons qualified in the transport of *radioactive material*.
- 579, 580 (g) Transport by post is not permitted.

### **B.13. OTHER PROVISIONS**

- 109, 507 (a) Other dangerous properties of contents and transport with other dangerous goods — see paras 109 and 507.
- 301–307 (b) General provisions for radiation protection — see paras 301–307.
- 308, 309, 555(c) (c) Accident provisions — see paras 308, 309 and 555(c).
- 310 (d) *Quality assurance* — see para. 310.
- 311 (e) *Compliance assurance* — see para. 311.
- 313 (f) Non-compliance — see para. 313.
- 314–316 (g) Training — see paras 314–316.
- 510, 511 (h) Damaged or leaking *packages* — see paras 510 and 511.
- 526, 527 (i) Determination of *transport index* — see paras 526 and 527.



**SCHEDULES 5-14**

- 528, 529      (j)      Determination of *criticality safety index* — see paras 528 and 529 (if applicable).
  
- 581            (k)      Customs — see para. 581.
  
- 582            (l)      Undeliverable *packages* — see para. 582.

## Schedule 5

### LOW SPECIFIC ACTIVITY MATERIAL (LSA-I)

<b>UN No.</b>
<b>2912, 2978 as applicable</b>

226(a), 672 *LSA-I* is the first of three groups of *radioactive material* which, by its nature, has a limited *specific activity* or for which limits of estimated average *specific activity* apply. *Fissile material* may only be present in quantities excepted under para. 672.

#### 1. MATERIALS

(a) See Common Provision B.1.

226(a) (b) *LSA-I* — *Radioactive material* meeting one of the following requirements:

(i) Uranium and thorium ores and concentrates of such ores, and other ores containing naturally occurring radionuclides which are intended to be processed for the use of these radionuclides;

(ii) Solid unirradiated *natural uranium* or *depleted uranium* or natural thorium or their solid or liquid compounds or mixtures; or

672 (iii) *Radioactive material* for which the  $A_2$  value is unlimited, excluding *fissile material* in quantities not excepted under para. 672;

401–406, 672 (iv) Other *radioactive material* in which the activity is distributed throughout and the estimated average *specific activity* does not exceed 30 times the values for activity concentration specified in paras 401–406, excluding *fissile material* in quantities not excepted under para. 672.

#### 2. PACKAGING/PACKAGE

(a) *LSA-I* material may be transported unpackaged if:

## SCHEDULE 5

- 523(a) (i) all material other than ores containing only naturally occurring radionuclides are transported in such a manner that under routine conditions of transport there will be no escape of the *radioactive contents* from the *conveyance* nor will there be any loss of shielding, and
- 523(b) (ii) it is transported in a *conveyance* under *exclusive use*.
- (b) Packaged *LSA-I* material may be transported if:
- 524 (i) the *package* meets the design requirements for a  
Table IV, *Type IP-1* (para. 621) or *Type IP-2* (para. 622) as appropriate for the physical form of the *LSA-I*. *LSA-I* shall be  
621, 622 packaged in *Type IP-1 packages*, except that liquid  
*LSA-I*, not transported under *exclusive use*, shall be  
624–628 packaged in *Type IP-2 packages*; or
- (ii) the *packaging* meets one of the alternative requirements for *tanks*, *freight containers* or *intermediate bulk containers* to be qualified as *Type IP-2* as given in paras 624–628; and
- 629–632 (iii) in the case of uranium hexafluoride, the *design* satisfies the requirements of paras 629–632.
- 801 (c) Except for *packages* containing 0.1 kg or more of uranium hexafluoride, *package design approval* is not required. However, the *consignor* shall be prepared to demonstrate the compliance of the *package design* with all the applicable requirements to the relevant *competent authority*.
- 802, 805 (d) *Competent authority approval* of *design* is required for *packages* designed to contain 0.1 kg or more of uranium hexafluoride according to paras 802 and 805.
- (e) *Packages* designed according to the 1985 or 1985 (As Amended 1990) Editions of these Regulations may be used provided they satisfy the transitional arrangements of Common Provision B.2(b).

### 3. MAXIMUM RADIATION LEVELS

- (a) See Common Provision B.3.

## LOW SPECIFIC ACTIVITY MATERIAL (LSA-I)

- 521 (b) The quantity of *LSA-I* in a single *package* shall be so restricted that the external *radiation level* at 3 m from the unshielded material does not exceed 10 mSv/h.

### 4. CONTAMINATION

See Common Provision B.4.

### 5. DECONTAMINATION

See Common Provision B.5.

### 6. MIXED CONTENTS

- 503 See Common Provision B.6. This requirement does not preclude the transport of *LSA-I* with other items.

### 7. LOADING AND SEGREGATION

See Common Provisions B.7(b)–B.7(e). For *consignments* of *LSA-I* material there shall be no limit on the sum of the *transport indexes*.

### 8. LABELLING AND MARKING

#### (a) Packages

- (i) See Common Provision B.8.
- 541, 542  
543(a) (ii) Completed WHITE or YELLOW labels (see Figs 2, 3 or 4, as appropriate), with the *radioactive contents* described on the label as “LSA-I”, shall be affixed externally to two opposite sides of the *package* or *overpack*, or to all four sides of *freight containers* and *tanks* when being used as *packages*.
- 535 (iii) *Packages* shall bear the mark “UN 2912”, and the proper shipping name “RADIOACTIVE MATERIAL, LOW SPECIFIC ACTIVITY (LSA-I)”. However, if the *package* contains uranium hexafluoride, the *package* shall bear the mark “UN 2978” and the proper shipping name “RADIOACTIVE MATERIAL, URANIUM HEXAFLUORIDE”.
- 537(a) (iv) Each *package* which conforms to a *Type IP-1* or a *Type IP-2* shall be marked with “Type IP-1” or “Type IP-2”, as appropriate.

## SCHEDULE 5

- 537(c) (v) Each *package* which conforms to a *Type IP-2* shall be marked with the international vehicle registration code of the country of origin of *design* and the name of the manufacturers, or other identification of the *packaging* specified by the *competent authority*.
- 538 (vi) *Packages* designed to contain more than 0.1 kg of uranium hexafluoride, and approved to para. 805, shall be legibly and durably marked on the outside of the *packaging* with both the identification mark allocated to the *design* by the *competent authority* and a serial number to uniquely identify each *packaging* which conforms to that *design*.
- 540 (vii) Where *LSA-I* is contained in receptacles or wrapping materials and is transported under *exclusive use*, the outer surface of these receptacles or wrapping materials may bear the marking "RADIOACTIVE LSA-I".
- (b) *Freight containers and overpacks:*
- 541, 542, 543(a) (i) See Common Provision B.8(b).
- (ii) Completed WHITE or YELLOW labels (see Figs 2, 3 or 4, as appropriate), with the *radioactive contents* described with the name of the radionuclide, or for mixtures the names of the most restrictive radionuclides, followed by "LSA-I", shall be affixed externally to all four sides of *freight containers*, or to two opposite sides of *overpacks*.

### 9. PLACARDING

- (a) See Common Provision B.9.
- 547 (b) For unpackaged *LSA-I* in a *freight container* or *tank*, or where an *exclusive use consignment* in a *freight container* is packaged *LSA-I* and no other UN Number commodities are present in the *freight container*, the UN Number "2912" shall be displayed on all four sides of the *freight container* or *tank*, either in the lower half of the placards shown in Fig. 6 and against the white background, or on the placards shown in Fig. 7.

LOW SPECIFIC ACTIVITY MATERIAL (LSA-I)

**10. TRANSPORT DOCUMENTS**

See Common Provision B.10.

**11. STORAGE AND DISPATCH**

(a) See Common Provision B.11.

566(a) (b) There is no limit on the total *transport index*.

**12. CARRIAGE**

(a) See Common Provision B.12.

523(b) (b) Transport of unpackaged *LSA-I* is only permitted under *exclusive use*.

566(a) (c) There is no limit on the total *transport index*.

525,  
Table V (d) There is no limit on the total activity in a single *conveyance*.

(e) *Shipment* by post is not permitted, except in limited quantities as specified in Schedule 1, and for manufactured articles in which the sole *radioactive material* is *natural uranium* or *depleted uranium* or natural thorium as specified in Schedule 3.

**13. OTHER PROVISIONS**

See Common Provision B.13.

## Schedule 6

### LOW SPECIFIC ACTIVITY MATERIAL (LSA-II)

UN No.
2977, 2978, 3321, 3324 as applicable

226(b), 672 *LSA-II* is the second of three groups of *radioactive material* which, by its nature, has a limited *specific activity* or for which limits of estimated average *specific activity* apply. If *fissile material* is present, other than *fissile material* meeting one of the provisions of para. 672, the requirements of Schedule 13 shall be met in addition to the requirements summarized in this Schedule.

#### 1. MATERIALS

(a) See Common Provision B.1.

226(b) (b) *LSA-II* — *Radioactive material* meeting one of the following requirements:

- (i) Water with tritium concentration up to 0.8 TBq/L;
- (ii) Solids and gases with activity distributed throughout of not more than  $10^{-4} A_2/g$ ; or
- (iii) Liquids with activity distributed throughout of not more than  $10^{-5} A_2/g$ .

#### 2. PACKAGING/PACKAGE

(a) See Common Provision B.2.

524 (b) *LSA-II* shall be transported in *packagings*.

524, 622, 623, Table IV (c) The *packaging* shall meet the design requirements for *Type IP-2* (para. 622) or *Type IP-3* (para. 623), as appropriate for the physical form of the *LSA-II*. *LSA-II* shall be packaged in *Type IP-2 packages*, except that liquid and gaseous *LSA-II*, not transported under *exclusive use*, shall be packaged in *Type IP-3 packages*.

## LOW SPECIFIC ACTIVITY MATERIAL (LSA-II)

- 624–628 (d) Alternative requirements for *tanks, freight containers* or *intermediate bulk containers* to be qualified as *Type IP-2* or *Type IP-3* are given in paras 624–628.
- 629–632 (e) Uranium hexafluoride may be transported as *LSA-II* provided the *package design* satisfies the requirements of paras 629–632.
- 672, 801 (f) Except for *packages* containing 0.1 kg or more of uranium hexafluoride, or containing *fissile material* in quantities not excepted under para. 672, *package design approval* is not required. However, the *consignor* shall be prepared to demonstrate the compliance of the *package design* with all applicable requirements to the relevant *competent authority*.
- 802, 805, 812 (g) *Competent authority approval of design* is required for *packages* designed to contain more than 0.1 kg of uranium hexafluoride or *fissile material* in quantities not excepted under para. 672.
- (h) Transitional arrangements for *Type IP-2* and *Type IP-3 packages* designed to a previous edition of these Regulations:
- (i) *Type IP-2* and *Type IP-3 package designs* approved to contain *fissile material* shall satisfy the transitional arrangements of Common Provisions B.2(c) and B.2(d), as appropriate.
- (ii) Other *Type IP-2* and *Type IP-3 package designs*, which previously did not require *competent authority* approval, shall satisfy the transitional arrangements of Common Provision B.2(b).
- 412 (i) For quantities exceeding 3000  $A_2$  and carried by air, the *packaging* shall meet the requirements for a *Type C package*.

### 3. MAXIMUM RADIATION LEVELS

- (a) See Common Provision B.3.
- 521 (b) The quantity of *LSA-II* in a single *package* shall be so restricted that the external *radiation level* at 3 m from the unshielded material does not exceed 10 mSv/h.



SCHEDULE 6

**4. CONTAMINATION**

See Common Provision B.4.

**5. DECONTAMINATION AND USE OF CONVEYANCES**

See Common Provision B.5.

**6. MIXED CONTENTS**

503 See Common Provision B.6. This requirement does not preclude the transport of *LSA-II* with other items.

**7. LOADING AND SEGREGATION**

(a) See Common Provision B.7.

525, Table V (b) The total activity in a single hold or compartment of an inland water craft, or in another *conveyance*, for carriage of *LSA-II* shall not exceed the limits shown in Table V.

**8. LABELLING AND MARKING**

(a) *Packages*

541, 542, 543(a) (i) See Common Provision B.8.  
(ii) Completed WHITE or YELLOW labels (see Figs 2, 3 or 4, as appropriate), with the *radioactive contents* described on the label “LSA-II”, shall be affixed externally to two opposite sides of the *package* or *over-pack*, or to all four sides of *freight containers* and *tanks* when being used as *packages*.

534, 535 (iii) *Packages* shall bear the mark “UN 3321” and the proper shipping name “RADIOACTIVE MATERIAL, LOW SPECIFIC ACTIVITY (LSA-II)”, if either non-fissile or fissile-excepted or, for *fissile material*, the *packages* shall bear the mark “UN 3324” and the proper shipping name “RADIOACTIVE MATERIAL, LOW SPECIFIC ACTIVITY (LSA-II), FISSILE”. However, if the *packages* contain non-fissile or fissile-excepted uranium hexafluoride, the *packages* shall bear the mark

## LOW SPECIFIC ACTIVITY MATERIAL (LSA-II)

- “UN 2978” and the proper shipping name “RADIOACTIVE MATERIAL, URANIUM HEXAFLUORIDE”, or for uranium hexafluoride that is *fissile material* they shall bear the mark “UN 2977” and the proper shipping name “RADIOACTIVE MATERIAL, URANIUM HEXAFLUORIDE, FISSILE”.
- 537(a) (iv) Each *package* which conforms to a *Type IP-2* or *Type IP-3* shall be marked with “Type IP-2” or “Type IP-3”, as appropriate.
- 537(c) (v) Each *package* which conforms to a *Type IP-2* or *Type IP-3* shall be marked with the international vehicle registration code of the country of origin of *design* and the name of the manufacturers, or other identification of the *packaging* specified by the *competent authority*.
- 538 (vi) *Packages* designed to contain more than 0.1 kg of uranium hexafluoride shall be legibly and durably marked on the outside of the *packaging* with both the identification mark allocated to the *design* by the *competent authority* and a serial number to uniquely identify each *packaging* which conforms to that *design*.
- (b) *Freight containers* and *overpacks*:
- 541, 542, 543(a) (i) See Common Provision B.8(b).
- (ii) Completed WHITE or YELLOW labels (see Figs 2, 3 or 4, as appropriate), with the *radioactive contents* described with the name of the radionuclide, or for mixtures the names of the most restrictive radionuclides, followed by “LSA-II”, shall be affixed externally to all four sides of *freight containers*, or to two opposite sides of *overpacks*.
- (iii) *Freight containers* and *overpacks* carrying mixed loads are referred to Schedule 13 in the case where they contain *packages* which themselves contain *fissile material*.

## 9. PLACARDING

- (a) See Common Provision B.9.
- 547 (b) Where an *exclusive use consignment* in a *freight container* is non-fissile or fissile-excepted *LSA-II* and no other UN Number

## SCHEDULE 6

commodities are present in the *freight container*, the UN Number “3321” shall be displayed on all four sides of the *freight container*, either in the lower half of the placards shown in Fig. 6 and against the white background, or on the placards shown in Fig. 7. In the case of *fissile material* transported as *LSA-II*, the UN Number “3324” shall be displayed on the placards.

### 10. TRANSPORT DOCUMENTS

See Common Provision B.10.

### 11. STORAGE AND DISPATCH

See Common Provision B.11.

### 12. CARRIAGE

(a) See Common Provision B.12.

524 (b) Transport of unpackaged *LSA-II* is not permitted.

525,  
Table V (c) Total activity in a single *conveyance* shall not exceed the values specified in Table V.

(d) *Shipment* by post is not permitted, except in limited quantities as summarized in Schedule 1.

### 13. OTHER PROVISIONS

See Common Provision B.13.

## Schedule 7

### LOW SPECIFIC ACTIVITY MATERIAL (LSA-III)

UN No.
2977, 2978, 3322, 3325 as applicable

226(c), 672 *LSA-III* is the third of three groups of *radioactive material* which, by its nature, has a limited *specific activity* or for which limits of estimated average *specific activity* apply. If *fissile material* is present, other than *fissile material* meeting one of the provisions of para. 672, the requirements of Schedule 13 shall be met in addition to the requirements summarized in this Schedule.

#### 1. MATERIALS

(a) See Common Provision B.1.

226(c) (b) *LSA-III* — Solid *radioactive material*, excluding powders, meeting one of the following requirements:

- (i) the *radioactive material* is distributed throughout a solid or collection of solid objects, or is essentially uniformly distributed in a solid compact binding agent (e.g. concrete, bitumen, ceramic);
- (ii) the *radioactive material* is relatively insoluble, or is intrinsically contained in a relatively insoluble matrix; and
- (iii) the estimated average *specific activity* does not exceed  $2 \times 10^{-3} A_2/g$ .

#### 2. PACKAGING/PACKAGE

(a) See Common Provision B.2.

524 (b) *LSA-III* shall be transported in *packagings*.

524, 622, 623, Table IV (c) The *packaging* shall meet the design requirements for *Type IP-2* (para. 622) if transported under *exclusive use*, or *Type IP-3* (para. 623) if not transported under *exclusive use*.

## SCHEDULE 7

- 627–628 (d) Alternative requirements for *freight containers* and *intermediate bulk containers* to be qualified as *Type IP-2* or *Type IP-3* are given in paras 627–628.
- 629–632 (e) Uranium hexafluoride may be transported as *LSA-III* provided the *design* satisfies the requirements of paras 629–632.
- 801 (f) Except for *packages* containing 0.1 kg or more of uranium hexafluoride, or containing *fissile material* in quantities not excepted under para. 672, *package design approval* is not required. However, the *consignor* shall be prepared to demonstrate the compliance of the *package design* with all applicable requirements to the relevant *competent authority*.
- 802, 805, 812 (g) *Competent authority approval of design* is required for *packages* designed to contain more than 0.1 kg of uranium hexafluoride or *fissile material* in quantities not excepted under para. 672.
- (h) Transitional arrangements for *Type IP-2* and *Type IP-3 packages* designed to a previous edition of these Regulations:
- (i) *Type IP-2* and *Type IP-3 package designs* approved to contain *fissile material* shall satisfy the transitional arrangements of Common Provisions B.2(c) and B.2(d), as appropriate.
- (ii) Other *Type IP-2* and *Type IP-3 package designs*, which previously did not require *competent authority* approval, shall satisfy the transitional arrangements of Common Provision B.2(b).
- 412 (j) For quantities exceeding 3000  $A_2$  and carried by air, the *packaging* shall meet the requirements for a *Type C package*.

### 3. MAXIMUM RADIATION LEVELS

- (a) See Common Provision B.3.
- 521 (b) The quantity of *LSA-III* in a single *package* shall be so restricted that the external *radiation level* at 3 m from the unshielded material does not exceed 10 mSv/h.

LOW SPECIFIC ACTIVITY MATERIAL (LSA-III)

**4. CONTAMINATION**

See Common Provision B.4.

**5. DECONTAMINATION**

See Common Provision B.5.

**6. MIXED CONTENTS**

503 See Common Provision B.6. This requirement does not preclude the transport of *LSA-III* with other items.

**7. LOADING AND SEGREGATION**

(a) See Common Provision B.7.

525, Table V (b) The total activity in a single hold or compartment of an inland water craft, or in another *conveyance*, for carriage of *LSA-III* shall not exceed the limits shown in Table V.

**8. LABELLING AND MARKING**

(a) *Packages*

541, 542, 543(a) (i) See Common Provision B.8.  
(ii) Completed WHITE or YELLOW labels (see Figs 2, 3 or 4, as appropriate), with the *radioactive contents* described on the label with the name of the radionuclide, or for mixtures the names of the most restrictive radionuclides, followed by "LSA-III", shall be affixed externally to two opposite sides of the *package*, or to all four sides of *freight containers* when being used as *packages*.

534, 535 (iii) *Packages* shall bear the mark "UN 3322" and the proper shipping name "RADIOACTIVE MATERIAL, LOW SPECIFIC ACTIVITY (LSA-III)" if either non-fissile or fissile-excepted or, for *fissile material*, the *packages* shall bear the mark "UN 3325" and the proper shipping name "RADIOACTIVE MATERIAL, LOW SPECIFIC ACTIVITY (LSA-III), FISSILE". However, if the

## SCHEDULE 7

*packages* contain non-fissile or fissile-excepted uranium hexafluoride, the *packages* shall bear the mark “UN 2978” and the proper shipping name “RADIOACTIVE MATERIAL, URANIUM HEXAFLUORIDE”, or for uranium hexafluoride that is *fissile material* they shall bear the mark “UN 2977” and the proper shipping name “RADIOACTIVE MATERIAL, URANIUM HEXAFLUORIDE, FISSILE”.

537(a) (iv) Each *package* which conforms to a *Type IP-2* or *Type IP-3* shall be marked with “Type IP-2” or “Type IP-3”, as appropriate.

537(c) (v) Each *package* which conforms to a *Type IP-2* or *Type IP-3* shall be marked with the international vehicle registration code of the country of origin of *design* and the name of the manufacturers, or other identification of the *packaging* specified by the *competent authority*.

538 (vi) *Packages* designed to contain more than 0.1 kg of uranium hexafluoride shall be legibly and durably marked on the outside of the *packaging* with both the identification mark allocated to the *design* by the *competent authority* and a serial number to uniquely identify each *packaging* which conforms to that *design*.

(b) *Freight containers and overpacks:*

- 541, 542,  
543(a)
- (i) See Common Provision B.8(b).
  - (ii) Completed WHITE or YELLOW labels (see Figs 2, 3 or 4, as appropriate), with the *radioactive contents* described with the name of the radionuclide, or for mixtures the names of the most restrictive radionuclides, followed by “LSA-III”, shall be affixed externally to all four sides of *freight containers*, or to two opposite sides of *overpacks*.
  - (iii) *Freight containers* and *overpacks* carrying mixed loads are referred to Schedule 13 in the case where they contain *packages* which themselves contain *fissile material*.

### 9. PLACARDING

- (a) See Common Provision B.9.

## LOW SPECIFIC ACTIVITY MATERIAL (LSA-III)

- 547 (b) Where an *exclusive use consignment* in a *freight container* is non-fissile or fissile-excepted *LSA-III* and no other UN Number commodities are present in the *freight container*, the UN Number “3322” shall be displayed on all four sides of the *freight container*, either in the lower half of the placards shown in Fig. 6 and against the white background, or on the placards shown in Fig. 7. In the case of *fissile material* transported as *LSA-III*, the UN Number “3325” shall be displayed on the placards.

### 10. TRANSPORT DOCUMENTS

See Common Provision B.10.

### 11. STORAGE AND DISPATCH

See Common Provision B.11.

### 12. CARRIAGE

- (a) See Common Provision B.12.
- 524 (b) Transport of unpackaged *LSA-III* is not permitted.
- 525, (c) Total activity in a single *conveyance* shall not exceed the values  
Table V specified in Table V.
- (d) *Shipment* by post is not permitted, except in limited quantities as summarized in Schedule 1.

### 13. OTHER PROVISIONS

See Common Provision B.13.



## Schedule 8

### SURFACE CONTAMINATED OBJECTS (SCO-I AND SCO-II)

<b>UN No.</b>
<b>2913, 3326, as applicable</b>

241, 672      A *surface contaminated object (SCO)* is a solid object which is not itself radioactive but which has *radioactive material* distributed on its surfaces. There are two groups, *SCO-I* and *SCO-II*, which differ in the maximum level of *contamination* permitted. If *fissile material* is present, other than *fissile material* meeting one of the provisions of para. 672, the requirements of Schedule 13 shall be met in addition to the requirements summarized in this Schedule.

#### 1. MATERIALS

(a) See Common Provision B.1.

241      (b) A solid, non-radioactive object, which has *radioactive material* distributed on its surfaces, may be classified as *SCO-I* or *SCO-II* when the *fixed* and *non-fixed surface contamination* levels, averaged over 300 cm<sup>2</sup> (or the area of the surface if less than 300 cm<sup>2</sup>), do not exceed the limits specified in Table 8.1.

#### 2. PACKAGING/PACKAGE

(a) *SCO-I* may be transported unpackaged if:

523(a)      (i) It is transported in such a manner that, in routine transport, there will be no escape of *radioactive contents* from the *conveyance* and no loss of shielding; and,

523(b)      (ii) For *SCO-I*, where it is suspected that *non-fixed contamination* exists on inaccessible surfaces in excess of 4 Bq/cm<sup>2</sup> for beta and gamma emitters and *low toxicity alpha emitters*, or 0.4 Bq/cm<sup>2</sup> for all other alpha emitters, measures are taken to ensure that the *radioactive material* is not released into the *conveyance* and it is transported under *exclusive use*.

523(c)

SURFACE CONTAMINATED OBJECTS (SCO-I AND SCO-II)

TABLE 8.1. SURFACE CONTAMINATION LIMITS (Bq/cm<sup>2</sup>) FOR SCO-I AND SCO-II

Type of emitters	Type of <i>contamination</i>		
	<i>Non-fixed</i> on accessible surface	<i>Fixed</i> on accessible surface	Sum of <i>fixed</i> and <i>non-fixed</i> on the inaccessible surface
<i>SCO-I</i> Beta/gamma emitters and <i>low toxicity alpha emitters</i>	4	$4 \times 10^4$	$4 \times 10^4$
All other alpha emitters	0.4	$4 \times 10^3$	$4 \times 10^3$
<i>SCO-II</i> Beta/gamma emitters and <i>low toxicity alpha emitters</i>	400	$8 \times 10^5$	$8 \times 10^5$
All other alpha emitters	40	$8 \times 10^4$	$8 \times 10^4$

(b) Packaged *SCO* may be transported if:

- |                                  |  |
|----------------------------------|--|
| 524, 621, 622, Table IV, 627–628 | <ul style="list-style-type: none"> <li>(i) The <i>package</i> meets the design requirements for <i>Type IP-1</i> (para. 621) for <i>SCO-I</i>, or <i>Type IP-2</i> (para. 622) for <i>SCO-II</i>; or</li> <li>(ii) The <i>packaging</i> meets one of the alternative requirements for <i>intermediate bulk containers</i> or <i>freight containers</i> to be qualified as <i>Type IP-2</i> as given in paras 627–628.</li> </ul> |
| 801                              | (c) Generally, <i>approval</i> of the <i>design</i> by the <i>competent authority</i> of <i>industrial packages</i> is not required, although the <i>consignor</i> shall be prepared to demonstrate the compliance of the <i>package design</i> to the appropriate <i>competent authority</i> .  |
| 802, 812                         | (d) <i>Competent authority approval</i> of <i>design</i> is required for <i>packages</i> designed to contain <i>SCO</i> contaminated with <i>fissile material</i> in quantities not excepted under para. 672.  |

## SCHEDULE 8

- (e) Transitional arrangements for *packages* designed to a previous edition of these Regulations:
- 816, 817 (i) *Package designs* approved to contain *fissile SCO material* shall satisfy the transition arrangements of Common Provisions B.2(b) and B.2(c).
- 815 (ii) Other *package designs* which previously did not require *competent authority approval* shall satisfy the transitional arrangements of Common Provision B.2(a).
- 412 (f) For quantities exceeding 3000  $A_2$  and carried by air, the *packaging* shall meet the requirements for a *Type C package*.

### 3. MAXIMUM RADIATION LEVELS

- (a) See Common Provision B.3.
- 521 (b) The quantity of *SCO* in a single *package* or object or collection of objects shall be so restricted that the external *radiation level* at 3 m from the unshielded material does not exceed 10 mSv/h.

### 4. CONTAMINATION

See Common Provision B.4.

### 5. DECONTAMINATION

See Common Provision B.5.

### 6. MIXED CONTENTS

- 503 See Common Provision B.6. This requirement does not preclude the transport of *SCO* with other items.

### 7. LOADING AND SEGREGATION

- (a) See Common Provision B.7.
- 525, Table V (b) The total activity in a single hold or compartment of an inland water craft, or in another *conveyance*, for carriage of *SCO* shall not exceed the limits shown in Table V.

## SURFACE CONTAMINATED OBJECTS (SCO-I AND SCO-II)

### 8. LABELLING AND MARKING

#### (a) *Packages*

- 541, 542,  
543(a)
- (i) See Common Provision B.8(a).
- (ii) Completed WHITE or YELLOW labels (see Figs 2, 3 or 4, as appropriate), with the *radioactive contents* described on the label with the name of the radionuclide, or for mixtures the names of the most restrictive radionuclides, followed by “SCO-I” or “SCO-II”, as appropriate, shall be affixed externally to two opposite sides of the *package*, or to all four sides of *freight containers* when being used as *packages*.
- 534, 535
- (iii) *Packages* shall bear the mark “UN 2913” and the proper shipping name “RADIOACTIVE MATERIAL, SURFACE CONTAMINATED OBJECTS (SCO-I or SCO-II)” if either non-fissile or fissile-excepted, or for *fissile material* the *packages* shall bear the mark “UN 3326” and the proper shipping name “RADIOACTIVE MATERIAL, SURFACE CONTAMINATED OBJECTS (SCO-I or SCO-II), FISSILE”.
- 537(a)
- (iv) Each *package* which conforms to a *Type IP-1* or *Type IP-2* shall be marked with “Type IP-1” or “Type IP-2”, as appropriate.
- 537(c)
- (v) Each *package* which conforms to a *Type IP-2* shall be marked with the international vehicle registration code of the country of origin of *design* and the name of the manufacturers, or other identification of the *packaging* specified by the *competent authority*.

#### (b) *Freight containers and overpacks:*

- 541, 542,  
543(a)
- (i) See Common Provision B.8(b).
- (ii) Completed WHITE or YELLOW labels (see Figs 2, 3 or 4, as appropriate), with the *radioactive contents* described with the name of the radionuclide, or for mixtures the names of the most restrictive radionuclides, followed by “SCO-I” or “SCO-II”, as appropriate, shall be affixed externally to all four sides of *freight containers*, or to two opposite sides of *overpacks*.

## SCHEDULE 8

### 9. PLACARDING

- (a) See Common Provision B.9.
- 547 (b) For unpackaged *SCO-I* in a *freight container*, or where an *exclusive use consignment* in a *freight container* is packaged non-fissile or fissile-excepted *SCO* and no other UN Number commodities are present in the *freight container*, the UN Number “2913” shall be displayed on all four sides of the *freight container*, either in the lower half of the placards shown in Fig. 6 and against the white background, or on the placards shown in Fig. 7. In the case of *fissile SCO*, the UN Number “3326” shall be displayed on the placards.

### 10. TRANSPORT DOCUMENTS

See Common Provision B.10.

### 11. STORAGE AND DISPATCH

See Common Provision B.11.

### 12. CARRIAGE

- (a) See Common Provision B.12.
- 523(b) (b) *SCO-I* on which the *contamination* on the accessible and inaccessible surfaces is not greater than 4 Bq/cm<sup>2</sup> for beta and gamma emitters and *low toxicity alpha emitters* or 0.4 Bq/cm<sup>2</sup> for all other alpha emitters may be transported unpackaged.
- 523(b) (c) *SCO-I* on which the *contamination* exceeds the values specified in (b) above may be transported unpackaged only under *exclusive use*.
- 524 (d) Transport of unpackaged *SCO-II* is not permitted.
- 525, (e) The total activity in a single *conveyance* shall not exceed 100  $A_2$

## SURFACE CONTAMINATED OBJECTS (SCO-I AND SCO-II)

Table V if the *conveyance* is other than an inland waterway craft, and 10  $A_2$  if the *consignment* of *SCO* is transported in the hold or compartment of an inland waterway craft.

- (f) *Shipment* by post is not permitted, except in limited quantities as summarized in Schedule 1.

### 13. OTHER PROVISIONS

See Common Provision B.13.

## Schedule 9

### MATERIAL IN TYPE A PACKAGES

UN No.
2915, 2977, 2978, 3327, 3332, 3333 as applicable

230(e), 672 *Radioactive material* in quantities representing a limited radiation risk may be carried in a *Type A package* which shall be designed to withstand normal conditions of transport. If *fissile material* is present, other than *fissile material* meeting one of the provisions of para. 672, the requirements of Schedule 13 shall be met in addition to the requirements summarized in this Schedule.

#### 1. MATERIALS

(a) See Common Provision B.1.

(b) *Radioactive material*:

- 201,  
401–406,  
Table I,  
Table II,  
413, 414
- (i) With an activity not exceeding  $A_1$  if as *special form radioactive material*, or,
  - (ii) With an activity not exceeding  $A_2$  if as other than *special form radioactive material*, or
  - (iii) For mixtures of radionuclides whose identities and respective activities are known, the condition given in para. 414 shall apply to the *radioactive contents* of a *Type A package*.

#### 2. PACKAGING/PACKAGE

(a) See Common Provision B.2.

(b) Transitional arrangements for *Type A packages* designed to a previous edition of these Regulations:

- (i) *Type A package designs* approved to contain *fissile material* shall satisfy the transitional arrangements of Common Provisions B.2(c) and B.2(d), as appropriate.

## MATERIAL IN TYPE A PACKAGES

- (ii) Other *Type A package designs*, which previously did not require *competent authority* approval, shall satisfy the transitional arrangements of Common Provision B.2(b).
- 633 (c) *Type A packages* shall meet the requirements specified in para. 633.
- 629–632 (d) *Type A packages* designed to transport 0.1 kg or more of uranium hexafluoride shall, in addition, satisfy the requirements specified in paras 629–632.
- 672, 801 (e) Except for *packages* containing 0.1 kg or more of uranium hexafluoride, or containing *fissile material* in quantities not excepted under para. 672, *package design approval* is not required. However, the *consignor* shall be prepared to demonstrate the compliance of the *package design* with all applicable requirements to the relevant *competent authority*.
- 802, 805, 812 (f) *Competent authority approval of design* is required for *packages* designed to contain more than 0.1 kg of uranium hexafluoride or *fissile material* in quantities not excepted under para. 672.
- 803, 804 (g) If the *radioactive contents* are *special form radioactive material*, *unilateral approval* of the *design* for the *special form radioactive material* is required.
- 818 (h) *Special form radioactive material* manufactured to a *design* which had received *unilateral approval* by the *competent authority* under the 1973, 1973 (As Amended), 1985 or 1985 (As Amended 1990) Editions of these Regulations may continue to be used when in compliance with the mandatory programme of *quality assurance* in accordance with the applicable requirements of para. 310. All *special form radioactive material* manufactured after 31 December 2003 shall meet this Edition of the Regulations in full.

### 3. MAXIMUM RADIATION LEVELS

See Common Provision B.3.



## SCHEDULE 9

### 4. CONTAMINATION

See Common Provision B.4.

### 5. DECONTAMINATION

See Common Provision B.5.

### 6. MIXED CONTENTS

See Common Provision B.6.

### 7. LOADING AND SEGREGATION

See Common Provision B.7.

### 8. LABELLING AND MARKING

#### (a) *Packages*

- 541, 542,  
543(a)
- (i) See Common Provision B.8(a).
- (ii) Completed WHITE or YELLOW labels (see Figs 2, 3 or 4, as appropriate), with the *radioactive contents* described on the label with the name of the radionuclide, or for mixtures the names of the most restrictive radionuclides shall be affixed externally to two opposite sides of the *package*, or to all four sides of *freight containers* and *tanks* when being used as *Type A packages*.
- 534, 535
- (iii) *Packages* containing *special form radioactive material* shall bear the mark "UN 3332" and the proper shipping name "RADIOACTIVE MATERIAL, TYPE A PACKAGE, SPECIAL FORM" if either non-fissile or fissile-excepted or, for *fissile material* the *packages* shall bear the mark "UN 3333" and the proper shipping name "RADIOACTIVE MATERIAL, TYPE A PACKAGE, SPECIAL FORM, FISSILE". *Packages* containing other *radioactive material* shall bear the mark "UN 2915" and the proper shipping name "RADIOACTIVE MATERIAL, TYPE A PACKAGE" if either non-fissile or fissile-excepted, or for *fissile material* the *package* shall bear the mark "UN 3327" and the proper shipping

## MATERIAL IN TYPE A PACKAGES

name “RADIOACTIVE MATERIAL, TYPE A PACKAGE, FISSILE”. However, if the *packages* contain non-fissile or fissile-excepted uranium hexafluoride, the *packages* shall bear the mark “UN 2978” and the proper shipping name “RADIOACTIVE MATERIAL, URANIUM HEXAFLUORIDE”, or for uranium hexafluoride that is *fissile material* they shall bear the mark “UN 2977” and the proper shipping name “RADIOACTIVE MATERIAL, URANIUM HEXAFLUORIDE, FISSILE”.

- 537(b) (iv) Each *package* which conforms to a *Type A package design* shall be marked with “Type A”.
- 537(c) (v) Each *package* which conforms to a *Type A package design* shall be marked with the international vehicle registration code of the country of origin of *design* and the name of the manufacturers, or other identification of the *packaging* specified by the *competent authority*.
- 538 (vi) *Packages* designed to contain more than 0.1 kg of uranium hexafluoride shall be legibly and durably marked on the outside of the *packaging* with both the identification mark allocated to the *design* by the *competent authority* and a serial number to uniquely identify each *packaging* which conforms to that *design*.

### (b) *Freight containers and overpacks:*

- 541, 542, 543(a) (i) See Common Provision B.8(b).
- (ii) Completed WHITE or YELLOW labels (see Figs 2, 3 or 4, as appropriate), with the *radioactive contents* described with the name of the radionuclide, or for mixtures the names of the most restrictive radionuclides, shall be affixed externally to all four sides of *freight containers*, or to two opposite sides of *overpacks*.

## 9. PLACARDING

- (a) See Common Provision B.9.
- 547 (b) Where an *exclusive use consignment* in a *freight container* is non-fissile or fissile-excepted *special form radioactive material* in *Type A packages* and no other UN Number commodities are

## SCHEDULE 9

present in the *freight container*, the UN Number “3332” shall be displayed on all four sides of the *freight container*, either in the lower half of the placards shown in Fig. 6 and against the white background, or on the placards shown in Fig. 7. In the case of *fissile material* transported as *special form radioactive material* in *Type A packages*, the UN Number “3333” shall be displayed on the placards.

- 547 (c) Where an *exclusive use consignment* in a *freight container* is non-fissile or fissile-excepted *radioactive material* in *Type A packages* and no other UN Number commodities are present in the *freight container*, the UN Number “2915” shall be displayed on all four sides of the *freight container*, either in the lower half of the placards shown in Fig. 6 and against the white background, or on the placards shown in Fig. 7. In the case of *fissile material* transported in *Type A packages*, the UN Number “3327” shall be displayed on the placards.

### 10. TRANSPORT DOCUMENTS

See Common Provision B.10.

### 11. STORAGE AND DISPATCH

See Common Provision B.11.

### 12. CARRIAGE

See Common Provision B.12.

### 13. OTHER PROVISIONS

See Common Provision B.13.

## Schedule 10

### MATERIAL IN TYPE B(U) PACKAGES

UN No.
2916, 3328 as applicable

230(f), 672 *Radioactive material* with an activity not exceeding any limit specified in the appropriate *competent authority* certificate of *unilateral approval* of *Type B(U) package design* may be carried in a *Type B(U) package*, which shall be so designed that it is unlikely to release its *radioactive contents* or lose its shielding integrity in accident conditions of transport. If *fissile material* is present, other than *fissile material* meeting one of the provisions of para. 672, the requirements of Schedule 13 shall be met in addition to the requirements summarized in this Schedule.

#### 1. MATERIALS

- (a) See Common Provision B.1.
- 415 (b) The limit on the total activity in a *Type B(U) package* is as prescribed in the *design* approval certificate for that *package*.
- 416 (c) *Type B(U) packages*, if transported by air, shall not contain activities greater than the following:
  - (i) For *low dispersible radioactive material* — as authorized for the *package design* as specified in the certificate of approval;
  - (ii) For *special form radioactive material* — 3000  $A_1$  or 100 000  $A_2$ , whichever is lower; or
  - (iii) For all other *radioactive material* — 3000  $A_2$ .

#### 2. PACKAGING/PACKAGE

- (a) See Common Provision B.2(a).

## SCHEDULE 10

- (b) Transitional arrangements for *package designs* approved to previous editions of the Regulations shall satisfy the transitional arrangements of Common Provisions B.2(c) and B.2(d).
- 650 (c) The *Type B(U) package* shall meet the requirements specified in para. 650.
- 629–632 (d) In addition, a *Type B(U) package* designed to contain uranium hexafluoride shall satisfy the requirements specified in paras 629–632.
- 803, 804 (e) If the *radioactive contents* are *special form radioactive material* and the activity exceeds the  $A_2$  activity limit and credit is taken for the *special form* nature of the *radioactive contents* in the *design*, *competent authority approval* of the *design* for the *special form radioactive material* is required.
- 818 (f) *Special form radioactive material* manufactured to a *design* which had received *unilateral approval* by the *competent authority* under the 1973, 1973 (As Amended), 1985 or 1985 (As Amended 1990) Editions of these Regulations may continue to be used when in compliance with the mandatory programme of *quality assurance* in accordance with the applicable requirements of para. 310. All *special form radioactive material* manufactured after 31 December 2003 shall meet this Edition of the Regulations in full.
- 803 (g) If the *radioactive contents* are *low dispersible radioactive material* and credit is taken for the *low dispersible* nature of the *radioactive contents* in the *design*, *multilateral competent authority approval* of the *design* for the *low dispersible radioactive material* is required.

### 3. MAXIMUM RADIATION LEVELS

See Common Provision B.3.

### 4. CONTAMINATION

See Common Provision B.4.

## MATERIAL IN TYPE B(U) PACKAGES

### 5. DECONTAMINATION

See Common Provision B.5.

### 6. MIXED CONTENTS

See Common Provision B.6.

### 7. LOADING AND SEGREGATION

See Common Provision B.7.

### 8. LABELLING AND MARKING

#### (a) *Packages*

- (i) See Common Provision B.8(a).
  - (ii) Completed WHITE or YELLOW labels (see Figs 2, 3 or 4, as appropriate), with the *radioactive contents* described on the label with the name of the radionuclide, or for mixtures the names of the most restrictive radionuclides shall be affixed externally to two opposite sides of the *package*, or to all four sides of *freight containers* and *tanks* when being used as *Type B(U) packages*.
  - (iii) *Packages* shall bear the mark “UN 2916” and the proper shipping name “RADIOACTIVE MATERIAL, TYPE B(U) PACKAGE” if either non-fissile or fissile-excepted or, for *fissile material*, the *packages* shall bear the mark “UN 3328” and the proper shipping name “RADIOACTIVE MATERIAL, TYPE B(U) PACKAGE, FISSILE”.
  - (iv) Each *package* which conforms to a *Type B(U) package design* shall be marked with “Type B(U)” and the trefoil symbol embossed or stamped on the outermost fire- and water-resistant receptacle.
  - (v) Each *package* which conforms to a *Type B(U) package design* shall be marked with the identification mark allocated to that *design* by the *competent authority* and a serial number to uniquely identify each *packaging* which conforms to that *design*.
- 541, 542  
543(a)
- 534, 535
- 538, 539
- 538

## SCHEDULE 10

- (b) *Freight containers and overpacks:*
- 541, 542,  
543(a)
- (i) See Common Provision B.8(b).
- (ii) Completed WHITE or YELLOW labels (see Figs 2, 3 or 4, as appropriate), with the *radioactive contents* described with the name of the radionuclide, or for mixtures the names of the most restrictive radionuclides, shall be affixed externally to all four sides of *freight containers*, or to two opposite sides of *overpacks*.

### 9. PLACARDING

- (a) See Common Provision B.9.
- 547
- (b) Where an *exclusive use consignment* in a *freight container* is non-fissile or fissile-excepted *radioactive material* in *Type B(U) packages* and no other UN Number commodities are present in the *freight container*, the UN Number “2916” shall be displayed on all four sides of the *freight container*, either in the lower half of the placards shown in Fig. 6 and against the white background, or on the placards shown in Fig. 7. In the case of *fissile material* transported in *Type B(U) packages*, the UN Number “3328” shall be displayed on the placards.

### 10. TRANSPORT DOCUMENTS

- (a) See Common Provision B.10.
- 806, 808
- (b) The *competent authority approval* certificate for the *package design* is required.
- 557, 561
- (c) Before the first *shipment* of any *Type B(U) package*, the *consignor* shall be in possession of all relevant approval certificates and shall ensure that copies of each applicable *competent authority approval* certificate have been submitted to the *competent authority* of each country through or into which the *package* is to be transported.
- 558
- (d) Before each *shipment* where the activity is greater than  $3 \times 10^3 A_1$  or  $3 \times 10^3 A_2$ , as appropriate, or 1000 TBq, whichever is the lower, the *consignor* shall notify the *competent authorities*

## MATERIAL IN TYPE B(U) PACKAGES

of all countries through or into which the *consignment* is to be transported preferably at least seven days in advance.

### 11. STORAGE AND DISPATCH

- (a) See Common Provision B.11.
- 501, 502 (b) The *consignor* shall have complied with the relevant pre-use and pre-shipment requirements of the Regulations.
- 502(c) (c) Any provisions in the *competent authority* approval certificates shall be observed.

### 12. CARRIAGE

- (a) See Common Provision B.12.
- 652, 662 (b) If the temperature of the accessible surface of the *package* could exceed 50°C in the shade, carriage by air is prohibited and carriage by other modes is permitted only under *exclusive use*, for which the surface temperature is limited to 85°C.

### 13. OTHER PROVISIONS

See Common Provision B.13.



## Schedule 11

### MATERIAL IN TYPE B(M) PACKAGES

UN No.
2917, 3329 as applicable

230(g), 672 *Radioactive material* with an activity not exceeding any limit specified in the appropriate *competent authority* certificate of *multilateral approval* of *Type B(M) package design* may be carried in a *Type B(M) package*, which shall be so designed that it is unlikely to release its *radioactive contents* or lose its shielding integrity in accident conditions of transport. If *fissile material* is present, other than *fissile material* meeting one of the provisions of para. 672, the requirements of Schedule 13 shall be met in addition to the requirements summarized in this Schedule.

#### 1. MATERIALS

- (a) See Common Provision B.1.
- (b) The limit on the total activity in a *Type B(M) package* is as prescribed in the *design approval* certificate for that *package*.

416 (c) *Type B(M) packages*, if transported by air, shall not contain activities greater than the following:

- (i) For *low dispersible radioactive material* — as authorized for the *package design* as specified in the certificate of approval;
- (ii) For *special form radioactive material* — 3000  $A_1$  or 100 000  $A_2$ , whichever is the lower; or
- (iii) For all other *radioactive material* — 3000  $A_2$ .

#### 2. PACKAGING/PACKAGE

- (a) See Common Provision B.2(a).

## MATERIAL IN TYPE B(M) PACKAGES

- (b) Transitional arrangements for *package designs* approved to previous editions of the Regulations shall satisfy the transitional arrangements of Common Provisions B.2(b) and B.2(c).
- 665 (c) The *Type B(M) package* shall meet the requirements specified in para. 665.
- 629–632 (d) In addition, a *Type B(M) package* designed to contain uranium hexafluoride shall satisfy the requirements specified in paras 629–632.
- 666 (e) Intermittent venting during transport may be permitted provided that the operational controls for venting are acceptable to the relevant *competent authorities*.
- 810 (f) Supplementary operational controls necessary to ensure the safety of the *Type B(M) package* during transport or to compensate for the deficiencies from the *Type B(U)* requirements and any restrictions on mode or conditions of transport shall be approved by the *competent authorities* involved (*multilateral approval*).
- 809, 811 (g) Approval of the *design* of *Type B(M) packages* is required both by the *competent authority* of the country of origin of the *design* and of each country through or into which the *packages* are transported (*multilateral approval*).
- 803 (h) If the *radioactive contents* are *special form radioactive material*, and the activity exceeds the  $A_2$  activity limit, and credit is taken for the *special form* nature of the *radioactive contents* in the *design*, *competent authority* approval of the *design* for the *special form radioactive material* is required.
- 818 (i) *Special form radioactive material* manufactured to a *design* which had received *unilateral approval* by the *competent authority* under the 1973, 1973 (As Amended), 1985 or 1985 (As Amended 1990) Editions of these Regulations may continue to be used when in compliance with the mandatory programme of *quality assurance* in accordance with the applicable requirements of para. 310. All *special form radioactive material* manufactured after 31 December 2003 shall meet this Edition of the Regulations in full.

## SCHEDULE 11

- 803 (j) If the *radioactive contents* are *low dispersible radioactive material*, and the activity exceeds the 3000  $A_2$  activity limit, and credit is taken for the *low dispersible* nature of the *radioactive contents* in the *design, competent authority* approval of the *design* for the *low dispersible radioactive material* is required.

### 3. MAXIMUM RADIATION LEVELS

See Common Provision B.3.

### 4. CONTAMINATION

See Common Provision B.4.

### 5. DECONTAMINATION

See Common Provision B.5.

### 6. MIXED CONTENTS

See Common Provision B.6.

### 7. LOADING AND SEGREGATION

See Common Provision B.7.

### 8. LABELLING AND MARKING

#### (a) Packages

- 541, 542,  
543(a) (i) See Common Provision B.8(a).  
(ii) Completed WHITE or YELLOW labels (see Figs 2, 3 or 4, as appropriate), with the *radioactive contents* described on the label with the name of the radionuclide, or for mixtures the names of the most restrictive radionuclides, shall be affixed externally to two opposite sides of the *package*, or to all four sides of *freight containers* and *tanks* when being used as *Type B(M) packages*.
- 534, 535 (iii) *Packages* shall bear the mark “UN 2917” and the proper shipping name “RADIOACTIVE MATERIAL, TYPE B(M) PACKAGE” if either non-fissile or fissile

## MATERIAL IN TYPE B(M) PACKAGES

- excepted, or for *fissile material* the *packages* shall bear the mark “UN 3329” and the proper shipping name “RADIOACTIVE MATERIAL, TYPE B(M) PACKAGE, FISSILE”.
- 538, 539 (iv) Each *package* which conforms to a *Type B(M) package design* shall be marked with “Type B(M)” and the trefoil symbol embossed or stamped on the outermost fire- and water-resistant receptacle.
- 538 (v) Each *package* which conforms to a *Type B(M) package design* shall be marked with the identification mark allocated to that *design* by the *competent authority* and a serial number to uniquely identify each *packaging* which conforms to that *design*.
- (b) *Freight containers and overpacks:*
- (i) See Common Provision B.8(b).
- 541, 542, 543(a) (ii) Completed WHITE or YELLOW labels (see Figs 2, 3 or 4, as appropriate), with the *radioactive contents* described with the name of the radionuclide, or for mixtures the names of the most restrictive nuclides, shall be affixed externally to all four sides of *freight containers*, or to two opposite sides of *overpacks*.

## 9. PLACARDING

- (a) See Common Provision B.9.
- 547 (b) Where an *exclusive use consignment* in a *freight container* or *tank* is non-fissile or fissile-excepted *radioactive material* in *Type B(M) packages* and no other UN Number commodities are present in the *freight container* or *tank*, the UN Number “2917” shall be displayed on all four sides of the *freight container* or *tank*, either in the lower half of the placards shown in Fig. 6 and against the white background, or on the placards shown in Fig. 7. In the case of *fissile material* transported in *Type B(M) packages*, the UN Number “3329” shall be displayed on the placards.

## 10. TRANSPORT DOCUMENTS

- (a) See Common Provision B.10.

## SCHEDULE 11

- 809, 811 (b) The *multilateral approval* certificate for the *package design* is required.
- 557, 561 (c) Before the first *shipment* of any *Type B(M) package*, the *consignor* shall be in possession of all relevant approval certificates and shall ensure that copies of each applicable *competent authority* approval certificate have been submitted to the *competent authority* of each country through or into which the *package* is to be transported.
- 558(c) (d) Before each *shipment*, the *consignor* shall notify the *competent authorities* of all countries through or into which the *consignment* is to be transported preferably at least seven days in advance.

### 11. STORAGE AND DISPATCH

- (a) See Common Provision B.11.
- 501, 502 (b) The *consignor* shall have complied with the relevant pre-use and pre-shipment requirements of the Regulations.
- 502(c) (c) Any provisions in the *competent authority* approval certificates shall be observed.

### 12. CARRIAGE

- (a) See Common Provision B.12.
- 652, 662 (b) If the temperature of the accessible surface of the *package* could exceed 50°C in the shade, carriage by air is prohibited and carriage by other modes is permitted only under *exclusive use*, for which the surface temperature is limited to 85°C.

### 13. OTHER PROVISIONS

See Common Provision B.13.

## Schedule 12

### MATERIAL IN TYPE C PACKAGES

UN No.
3323, 3330 as applicable

230(e), 672 *Radioactive material* with an activity not exceeding any limit specified in the appropriate *competent authority* certificate of *unilateral approval* of *Type C package design* may be carried in a *Type C package*, which shall be so designed that it is unlikely to release its *radioactive contents* or lose its shielding integrity in accident conditions of transport, including those associated with the air mode. If *fissile material* is present, other than *fissile material* meeting one of the provisions of para. 672, the requirements of Schedule 13 shall be met in addition to the requirements summarized in this Schedule.

#### 1. MATERIALS

(a) See Common Provision B.1.

417 (b) The limit on the total activity in a *Type C package* is as prescribed in the *design approval* certificate for that *package*.

#### 2. PACKAGING/PACKAGE

667 (a) The *packaging* shall meet the requirements specified in para. 667.

629–632 (b) In addition, a *Type C package* designed to contain uranium hexafluoride shall satisfy the requirements specified in paras 629–632.

803, 804 (c) If the *radioactive contents* are *special form radioactive material* and the activity exceeds the  $A_2$  activity limit and credit is taken for the *special form* nature of the *radioactive contents* in the *design*, *competent authority approval* of the *design* for the *special form radioactive material* is required.

## SCHEDULE 12

- 818 (d) *Special form radioactive material* manufactured to a *design* which had received *unilateral approval* by the *competent authority* under the 1973, 1973 (As Amended), 1985 or 1985 (As Amended 1990) Editions of these Regulations may continue to be used when in compliance with the mandatory programme of *quality assurance* in accordance with the applicable requirements of para. 310. All *special form radioactive material* manufactured after 31 December 2003 shall meet this Edition of the Regulations in full.

### 3. MAXIMUM RADIATION LEVELS

See Common Provision B.3.

### 4. CONTAMINATION

See Common Provision B.4.

### 5. DECONTAMINATION

See Common Provision B.5.

### 6. MIXED CONTENTS

See Common Provision B.6.

### 7. LOADING AND SEGREGATION

See Common Provision B.7.

### 8. LABELLING AND MARKING

#### (a) *Packages*

- 541, 542,  
543(a)
- (i) See Common Provision B.8.
  - (ii) Completed WHITE or YELLOW labels (see Figs 2, 3 or 4, as appropriate), with the *radioactive contents* described on the label with the name of the radionuclide, or for mixtures the names of the most restrictive radionuclides shall be affixed externally to two opposite sides

## MATERIAL IN TYPE C PACKAGES

- of the *package*, or to all four sides of *freight containers* and *tanks* when being used as *Type C packages*.
- 534, 535 (iii) *Packages* shall bear the mark “UN 3323” and the proper shipping name “RADIOACTIVE MATERIAL, TYPE C PACKAGE” if either non-fissile or fissile-excepted, or for *fissile material* the *packages* shall bear the mark “UN 3330” and the proper shipping name “RADIOACTIVE MATERIAL, TYPE C PACKAGE, FISSILE”.
- 538, 539 (iv) Each *package* which conforms to a *Type C package design* shall be marked with “Type C” and the trefoil symbol embossed or stamped on the outermost fire- and water-resistant receptacle.
- 538 (v) Each *package* which conforms to a *Type C package design* shall be marked with the identification mark allocated to that *design* by the *competent authority* and a serial number to uniquely identify each *packaging* which conforms to that *design*.
- (b) *Freight containers* and *overpacks*:
- (i) See Common Provision B.8(b).
- 541, 542 (ii) Completed WHITE or YELLOW labels (see Figs 2, 543(a) 3 or 4, as appropriate), with the *radioactive contents* described with the name of the radionuclide, or for mixtures the names of the most restrictive radionuclides shall be affixed externally to all four sides of *freight containers*, or to two opposite sides of *overpacks*.

## 9. PLACARDING

- (a) See Common Provision B.9.
- 547 (b) Where an *exclusive use consignment* in a *freight container* is non-fissile or fissile-excepted *radioactive material* in *Type C packages* and no other UN Number commodities are present in the *freight container*, the UN Number “3323” shall be displayed on all four sides of the *freight container*, either in the lower half of the placards shown in Fig. 6 and against the white background, or on the placards shown in Fig. 7. In the case of *fissile material* transported in *Type C packages*, the UN Number “3330” shall be displayed on the placards.



## SCHEDULE 12

### 10. TRANSPORT DOCUMENTS

- (a) See Common Provision B.10.
- 806, 808 (b) The *unilateral approval* certificate for the *package design* is required.
- 557, 561 (c) Before the first *shipment* of any *Type C package*, the *consignor* shall be in possession of all relevant approval certificates and shall ensure that copies of each applicable *competent authority* approval certificate have been submitted to the *competent authority* of each country through or into which the *package* is to be transported.
- 558 (d) Before each *shipment* where the activity is greater than  $3 \times 10^3 A_1$  or  $3 \times 10^3 A_2$ , as appropriate, or 1000 TBq, whichever is the lower, the *consignor* shall notify the *competent authorities* of all countries through or into which the *consignment* is to be transported preferably at least seven days in advance.

### 11. STORAGE AND DISPATCH

- (a) See Common Provision B.11.
- 501, 502 (b) The *consignor* shall have complied with the relevant pre-use and pre-shipment requirements of the Regulations.
- 502(c) (c) Any provisions in the *competent authority* approval certificates shall be observed.

### 12. CARRIAGE

- (a) See Common Provision B.12.
- 652, 662 (b) If the temperature of the accessible surface of the *package* could exceed 50°C in the shade, carriage by air is prohibited and carriage by other modes is permitted only under *exclusive use*, for which the surface temperature is limited to 85°C.

### 13. OTHER PROVISIONS

See Common Provision B.13.

## Schedule 13

### FISSILE MATERIAL

UN No.
2977, 3324, 3325, 3326, 3327, 3328, 3329, 3330, 3331, 3333 as applicable

671 *Radioactive material* which is also *fissile material* (except those *fissile materials* which are fissile-excepted by satisfying one of the requirements of para. 672 of the Regulations) shall be packaged, transported and stored so as to meet the requirements specified in the Regulations for nuclear criticality safety (as summarized in this Schedule) and the requirements appropriate to its radioactivity (as summarized in Schedules 6–12 and 14, as appropriate).

#### 1. MATERIALS

222 *Fissile material* is uranium-233, uranium-235, plutonium-239, plutonium-241, or any combination of these radionuclides, except for *unirradiated natural uranium* and *depleted uranium*, and *natural uranium* or *depleted uranium* which has been irradiated in thermal reactors only.

*Consignments of fissile material* shall also be in full compliance with the requirements of the Regulations summarized in one of the other Schedules, as appropriate to the radioactivity of the *consignment*.

#### 2. PACKAGING/PACKAGE

- (a) See Common Provision B.2.
- 672 (b) *Fissile material* meeting one of the provisions (a)–(d) of para. 672 is excepted from the requirement to be transported in *packages* that comply with para. 671 as well as the other requirements of these Regulations that apply to *fissile material*. Only one type of exception is allowed per *consignment*.
- 671 (c) Otherwise, *packages* containing *fissile material* shall meet the design requirements for the type of *package* necessary for the

### SCHEDULE 13

radioactivity of the *fissile material* (i.e. *Type IP-2, Type IP-3, Type A, Type B(U), Type B(M) or Type C*) and, in addition, shall meet the requirements for *packages* containing *fissile material*.

- 673–682 (d) *Fissile material* shall be packaged and shipped in such a manner that it will remain subcritical under conditions likely to be encountered in routine transport and in accidents.
- 802, 812 (e) Each *package design* for *fissile material* shall be approved by the *competent authority* of the country of origin of the *design* and of each of the countries through or into which the *package* is to be transported, i.e. *multilateral approval* is required.
- (f) Transitional arrangements for *packages* designed to contain *fissile material* and designed to a previous edition of these Regulations shall satisfy the requirements of Common Provision B.2(c) or B.2(d), as appropriate.

#### 3. MAXIMUM RADIATION LEVELS

See Common Provision B.3.

#### 4. CONTAMINATION

See Common Provision B.4.

#### 5. DECONTAMINATION

See Common Provision B.5.

#### 6. MIXED CONTENTS

See Common Provision B.6.

#### 7. LOADING AND SEGREGATION

- (a) See Common Provision B.7.
- 529, 566(d), 568, 569 (b) The loading of *freight containers* and the accumulation of *packages, overpacks* and *freight containers* aboard a single

## FISSILE MATERIAL

Table X                      *conveyance* shall be so limited that the total sum of the *criticality safety indexes* in a *freight container* and aboard a single *conveyance* shall not exceed the values shown in Table X. Any group of *packages, overpacks* and *freight containers* containing *fissile material* stored in transit in any one storage area shall be so limited that the total sum of the *criticality safety indexes* in the group does not exceed 50.

529, 568,            (c)      Except under the condition of *exclusive use* the *consignment* Table X                      shall be so handled and stowed that the total sum of *CSI's* in any group does not exceed 50, and that each group is handled and stowed so that the groups are separated from each other by at least 6 m.

529, Table X      (d)      Where a *consignment* is transported under *exclusive use* the *con-* *signment* shall be so handled and stowed that the total sum of *CSI's* in any group does not exceed 100, and that each group is handled and stowed so that the groups are separated from each other by at least 6 m. The intervening space between groups may be occupied by other cargo in accordance with para. 505.

### 8. LABELLING AND MARKING

(a)      *Packages*

(i)      See Common Provision B.8(a)

(ii)     See appropriate Schedule

and in addition;

541, 542,            (iii)     Completed *criticality safety index* labels (see Fig. 5), Table X                      544                      with the *criticality safety index* as stated in the certificate of approval for *package design* or the certificate of approval for *special arrangement*, shall be affixed externally to two opposite sides of the *package*, or to all four sides of *freight containers* and *tanks* when being used as *packages*.

(b)      *Freight containers* and *overpacks*:

(i)      See Common Provision B.8(b)

(ii)     See appropriate Schedule

and in addition;

## SCHEDULE 13

- 545 (iii) The *criticality safety index* entered on the labels of the *overpack* or *freight container* shall be the total for the entire fissile contents of the *overpack* or *freight container*. The labels shall be affixed externally to all four sides of *freight containers*, or two opposite sides of *overpacks*.

### 9. PLACARDING

See appropriate Schedule.

### 10. TRANSPORT DOCUMENTS

- (a) See Common Provision B.10.
- 812–814,  
561 (b) The *multilateral approval* certificate for the *fissile material package design* is required from the *competent authority* of each country through or into which the *package* is to be transported.
- 820(c) (c) Certificates of *multilateral approval* of *shipment* are required for *packages* containing *fissile material* if the sum of the *criticality safety indexes* of the *packages* in the *consignment* exceeds 50.
- (d) For additional documentation requirements, see appropriate Schedule.

### 11. STORAGE AND DISPATCH

- (a) See Common Provision B.11.
- 566(d), 568,  
569, Table X (b) See Provisions 7(b), (c) and (d) of this Schedule.

### 12. CARRIAGE

- (a) See Common Provisions B.12(a) and B.12(b).
- 530, 567 (b) Any *package*, *overpack* or *consignment* having a *criticality safety index* greater than 50 shall be transported only under the condition of *exclusive use*.

## FISSILE MATERIAL

- 566(d), 568, (c) See Provisions 7(b), (c) and (d) of this Schedule.  
569, Table X
- (d) Shipment by post is not permitted.

### **13. OTHER PROVISIONS**

See Common Provision B.13.

## Schedule 14

### MATERIAL TRANSPORTED UNDER SPECIAL ARRANGEMENT

UN No.
2919, 3331 as applicable

*Radioactive material* as specified in the appropriate certificate of *multilateral approval of shipment* under *special arrangement* may be transported under *special arrangement*, subject to the implementation of special provisions approved by the *competent authority* (or *competent authorities* for international *shipments*). These provisions will be established to ensure that the overall level of safety in transport and during storage in transit shall be at least equivalent to that which would be provided if all the applicable requirements of Schedules 1-13, as appropriate, had been satisfied.

#### 1. MATERIALS

*Radioactive material* which may be shipped under *special arrangement* includes any of the materials covered by Schedules 5-12, and, in addition, Schedule 13 if applicable.

#### 2. PACKAGING/PACKAGE

312 (a) Provisions shall be adequate to ensure that the overall level of safety in transport and during storage in transit is at least equivalent to that which would be provided if all applicable requirements had been satisfied.

312, 802 (b) For domestic *shipments*, approval of provisions by the *competent authority* is required.

312, 824 (c) For international *shipments*, *multilateral approval* is required.

#### 3. MAXIMUM RADIATION LEVELS

(a) See Common Provision B.3.

## MATERIAL TRANSPORTED UNDER SPECIAL ARRANGEMENT

- (b) The maximum *radiation levels* for *packages* transported under *special arrangement* shall be approved by the *competent authorities*.

### 4. CONTAMINATION

- (a) See Common Provision B.4.
- 825(b) (b) The limits allowed by the *competent authorities* approval certificates for *special arrangement* shall be complied with.

### 5. DECONTAMINATION

- (a) See Common Provision B.5.
- 825(b) (b) The limits allowed by the *competent authorities* approval certificates for *special arrangement* shall be complied with.

### 6. MIXED CONTENTS

- (a) See Common Provision B.6.
- 825(b) (b) As allowed by the *competent authorities* approval certificates for *special arrangement*.

### 7. LOADING AND SEGREGATION

- (a) See Common Provision B.7.
- 825(b) (b) Specific loading and segregation requirements approved by the *competent authorities* shall be fulfilled.

### 8. LABELLING AND MARKING

- (a) *Packages*
  - (i) See Common Provision B.8(a).
  - 533(d) (ii) Completed III-YELLOW labels (see Fig. 4), with the *radioactive contents* described on the label with the name of the radionuclide, or for mixtures the names of the most restrictive radionuclides, shall be affixed



## SCHEDULE 14

externally to two opposite sides of the *package*, or to all four sides of *freight containers* and *tanks* when being used as *packages*.

- 534, 535
- (iii) *Packages* shall bear the mark “UN 2919” and the proper shipping name “RADIOACTIVE MATERIAL, TRANSPORTED UNDER SPECIAL ARRANGEMENT” if either non-fissile or fissile-excepted, or for *fissile material* the *packages* shall bear the mark “UN 3331” and the proper shipping name “RADIOACTIVE MATERIAL, TRANSPORTED UNDER SPECIAL ARRANGEMENT, FISSILE”.
  - (iv) Other labelling and marking requirements approved by the *competent authorities* shall be fulfilled.
- (b) *Freight containers* and *overpacks*:
- (i) See Common Provision B.8(b).
  - (ii) Completed III-YELLOW labels (see Fig. 4), with the *radioactive contents* described with the name of the radionuclide, or for mixtures the names of the most restrictive nuclides, shall be affixed externally to all four sides of *freight containers*, or to two opposite sides of *overpacks*.
  - (iii) Other labelling and marking requirements approved by the *competent authorities* shall be fulfilled.
- 533(d), 541,  
542,  
543(a)

### 9. PLACARDING

- (a) See Common Provision B.9.
  - (b) Where an *exclusive use consignment* in a *freight container* or *tank* is non-fissile or fissile-excepted *radioactive material* being transported under *special arrangement* and no other UN Number commodities are present in the *freight container* or *tank*, the UN Number “2919” shall be displayed on all four sides of the *freight container* or *tank*, either in the lower half of the placards shown in Fig. 6 and against the white background, or on the placards shown in Fig. 7. In the case of *fissile material* being transported under *special arrangement* the UN Number “3331” shall be displayed on the placards.
- 547

## MATERIAL TRANSPORTED UNDER SPECIAL ARRANGEMENT

- (c) Other placarding requirements approved by the *competent authorities* shall be fulfilled.

### 10. TRANSPORT DOCUMENTS

- (a) See Common Provision B.10.
- 802,  
824–826 (b) Each *consignment* shipped under *special arrangement* shall require *multilateral approval*.
- 558 (c) Before each *shipment* performed under *special arrangement*, the *consignor* shall be in possession of all relevant approval certificates.
- 558 (d) Before each *shipment* the *consignor* shall notify the *competent authorities* of all countries through or into which the *consignment* is to be transported preferably at least seven days in advance.

### 11. STORAGE AND DISPATCH

- (a) See Common Provision B.11.
- (b) Specific storage and dispatch requirements approved by the *competent authorities* shall be fulfilled.

### 12. CARRIAGE

- (a) See Common Provision B.12.
- (b) Specific carriage requirements approved by the *competent authorities* shall be fulfilled.

### 13. OTHER PROVISIONS

- (a) See Common Provision B.13.
- (b) Other specific requirements approved by the *competent authorities* shall be fulfilled.

## **ANNEXES**

## **Annex I**

### **SUMMARY OF APPROVAL AND PRIOR NOTIFICATION REQUIREMENTS**

This summary reflects the contents of the Regulations for the Safe Transport of Radioactive Material (1996 Edition). The user's attention is called to the fact that there may be deviations (exceptions, additions, etc.) relative to:

- (a) national regulations relating to safety
- (b) *carrier* restrictions, and
- (c) national regulations relating to security, physical protection, liability, insurance, pre-notification and/or routing, and import/export/transit licensing.

**SUMMARY OF APPROVAL AND PRIOR NOTIFICATION REQUIREMENTS**

Key paragraphs in the Regulations	Class of <i>package</i> or material	Competent authority approval required		Consignor required to notify country of origin and countries en route <sup>a</sup> of each <i>shipment</i>
		Country of origin	Countries en route <sup>a</sup>	
	<i>Excepted package</i> <sup>b</sup> by domestic post	No	Not applicable	No
	<i>Excepted package</i> <sup>b</sup> by international post	Yes, of consignor	No	No
	— <i>Package design</i>	No	No	No
	— <i>Shipment</i>	No	No	No
580	— <i>Consignor</i>	Yes	Not applicable	No
	<i>Excepted package</i> <sup>b</sup> other than by post	No	No	No
	<i>LSA material</i> <sup>b,c</sup> and <i>SCO</i> <sup>c</sup>	No	No	No
	— <i>Type IP-1, Type IP-2 or Type IP-3</i>			
	<i>Type A</i> <sup>b,c</sup>	No	No	No

<sup>a</sup> Countries through or into which (but not over which) the *consignment* is transported (see para. 204 of the Regulations).

<sup>b</sup> If the *radioactive contents* are UF<sub>6</sub> in quantities of 0.1 kg or more, the approval requirements for *packages* containing uranium hexafluoride shall additionally apply (see paras 802 and 805 of the Regulations).

<sup>c</sup> If the *radioactive contents* are *fissile material* which is not excepted from the requirements for *packages* containing *fissile material*, then the approval requirements in paras 812 and 820 of the Regulations shall additionally apply.

## ANNEX I

Key paragraphs in the Regulations	Class of package or material	Competent authority approval required		Consignor required to notify country of origin and countries en route <sup>a</sup> of each shipment
		Country of origin	Countries en route <sup>a</sup>	
<i>Type B(U)</i> <sup>b,c</sup>				
806, 820	— <i>Package design</i>	Yes	No <sup>d</sup>	
557, 558	— <i>Shipment</i>	No	No	(See Notes 1 + 2)
<i>Type B(M)</i> <sup>b,c</sup>				
809, 820	— <i>Package design</i>	Yes	Yes	Yes
557, 558	— <i>Shipment</i>	(See Note 3)	(See Note 3)	(See Note 1)
<i>Type C</i> <sup>b,c</sup>				
806, 820	— <i>Package design</i>	Yes	No	
557, 558	— <i>Shipment</i>	No	No	(See Notes 1 + 2)

<sup>a</sup> Countries through or into which (but not over which) the *consignment* is transported (see para. 204 of the Regulations).

<sup>b</sup> If the *radioactive contents* are *fissile material* which is not excepted from the requirements for *packages* containing *fissile material*, then the approval requirements in paras 812 and 820 of the Regulations shall additionally apply.

<sup>c</sup> If the *radioactive contents* are UF<sub>6</sub> in quantities of 0.1 kg or more, the approval requirements for *packages* containing uranium hexafluoride shall additionally apply (see paras 802 and 805 of the Regulations).

<sup>d</sup> If the *radioactive contents* are *low dispersible radioactive material*, and the *package* is to be shipped by air, *multilateral approval* of the *package design* is required (see para. 806(b) of the Regulations).

Note 1 — Before the first *shipment* of any *package* requiring *competent authority* approval of the *design*, the *consignor* shall ensure that a copy of the approval certificate for that *design* has been submitted to the *competent authority* of each country (see para. 557 of the Regulations).

Note 2 — Notification required if contents exceed  $3 \times 10^3 A_1$ , or  $3 \times 10^3 A_2$ , or 1000 TBq, whichever is the lower (see para. 558 of the Regulations).

Note 3 — *Multilateral approval* of *shipment* required if contents exceed  $3 \times 10^3 A_1$ , or  $3 \times 10^3 A_2$ , or 1000 TBq, whichever is the lower; or if controlled intermittent venting is allowed (see para. 820 of the Regulations).

**SUMMARY OF APPROVAL AND PRIOR NOTIFICATION REQUIREMENTS**

Key paragraphs in the Regulations	Class of <i>package</i> or material	Competent authority approval required		Consignor required to notify country of origin and countries en route <sup>a</sup> of each <i>shipment</i>
		Country of origin	Countries en route <sup>a</sup>	
	<i>Packages for fissile material</i>			
812	— <i>Package design</i>	Yes <sup>b</sup>	Yes <sup>b</sup>	
820	— <i>Shipment</i>			
	Σ CSI ≤ 50	No <sup>c</sup>	No <sup>c</sup>	(See Notes 1 + 2)
	Σ CSI >50	Yes	Yes	(See Notes 1 + 2)
	<i>Packages containing 0.1 kg or more of uranium hexafluoride</i>			
805	— <i>Package design</i>	No <sup>d</sup>	No <sup>d</sup>	
820	— <i>Shipment</i>	No <sup>c</sup>	No <sup>c</sup>	(See Note 2)

<sup>a</sup> Countries through or into which (but not over which) the *consignment* is transported (see para. 204 of the Regulations).

<sup>b</sup> *Designs* of *packages* containing *fissile material* may also require approval in respect of one of the other items in Annex I.

<sup>c</sup> *Shipments* may, however, require approval in respect of one of the other items in Annex I.

<sup>d</sup> Except that after 31 December 2000, designs that only meet the requirement of para. 632 require *multilateral approval*, and after 31 December 2003, designs that meet the requirements of paras 629–631 require *unilateral approval* by the *competent authority* of the country of origin of the *design* (805).

Note 1 — The *multilateral approval* requirement for *fissile packages* and some uranium hexafluoride *packages* automatically satisfies the requirement of para. 557 of the Regulations.

Note 2 — Notification required if contents exceed  $3 \times 10^3 A_1$ , or  $3 \times 10^3 A_2$ , or 1000 TBq, whichever is the lower (see para. 558 of the Regulations).

## ANNEX I

Key paragraphs in the Regulations	Class of package or material	Competent authority approval required		Consignor required to notify country of origin and countries en route <sup>a</sup> of each shipment
		Country of origin	Countries en route <sup>a</sup>	
<i>Special form radioactive material</i>				
803	— Design	Yes	No	No
820	— Shipment	(See Note 1)	(See Note 1)	(See Note 1)
<i>Low dispersible radioactive material</i>				
803	— Design	Yes	Yes	No
820	— Shipment	(See Note 1)	(See Note 1)	(See Note 1)
<i>Special arrangement</i>				
802 824, 558	— Shipment	Yes	Yes	Yes
<i>Type B(U) packages for which design approved under:</i>				
816	1973 Regulations	Yes	Yes	(See Note 2)
817	1985 Regulations	Yes	No until 31 December 2003 Yes thereafter	(See Note 2)

<sup>a</sup> Countries through or into which (but not over which) the *consignment* is transported (see para. 204 of the Regulations).

Note 1 — See approval and prior notification requirements for applicable *package*.

Note 2 — Before the first *shipment* of any *package* requiring *competent authority* approval of the *design*, the *consignor* shall ensure that a copy of the approval certificate for that *design* has been submitted to the *competent authority* of each country (see para. 557 of the Regulations).



## Annex II

### CONVERSION FACTORS AND PREFIXES

This edition of the Regulations for the Safe Transport of Radioactive Material uses the International System of Units (SI). The conversion factors for non-SI units are:

#### RADIATION UNITS

Activity in becquerel (Bq) or curie (Ci)

$$1 \text{ Ci} = 3.7 \times 10^{10} \text{ Bq}$$

$$1 \text{ Bq} = 2.7 \times 10^{-11} \text{ Ci}$$

Dose equivalent in sievert (Sv) or rem

$$1 \text{ rem} = 1.0 \times 10^{-2} \text{ Sv}$$

$$1 \text{ Sv} = 100 \text{ rem}$$

#### PRESSURE

Pressure in pascal (Pa) or (kgf/cm<sup>2</sup>)

$$1 \text{ kgf/cm}^2 = 9.806 \times 10^4 \text{ Pa}$$

$$1 \text{ Pa} = 1.020 \times 10^{-5} \text{ kgf/cm}^2$$

#### CONDUCTIVITY

Conductivity in siemens per metre (S/m) or (mho/cm)

$$10 \text{ } \mu\text{mho/cm} = 1 \text{ mS/m}$$

or

$$1 \text{ mho/cm} = 100 \text{ S/m}$$

$$1 \text{ S/m} = 10^{-2} \text{ mho/cm}$$

## ANNEX II

### SI PREFIXES

The prefixes to be used with the SI units are:

Multiplying factor	Prefix	Symbol
1 000 000 000 000 000 000 = 10 <sup>18</sup>	exa	E
1 000 000 000 000 000 = 10 <sup>15</sup>	peta	P
1 000 000 000 000 = 10 <sup>12</sup>	tera	T
1 000 000 000 = 10 <sup>9</sup>	giga	G
1 000 000 = 10 <sup>6</sup>	mega	M
1 000 = 10 <sup>3</sup>	kilo	k
100 = 10 <sup>2</sup>	hecto	h
10 = 10 <sup>1</sup>	deca	da
0.1 = 10 <sup>-1</sup>	deci	d
0.01 = 10 <sup>-2</sup>	centi	c
0.001 = 10 <sup>-3</sup>	milli	m
0.000 001 = 10 <sup>-6</sup>	micro	μ
0.000 000 001 = 10 <sup>-9</sup>	nano	n
0.000 000 000 001 = 10 <sup>-12</sup>	pico	p
0.000 000 000 000 001 = 10 <sup>-15</sup>	femto	f
0.000 000 000 000 000 001 = 10 <sup>-18</sup>	atto	a

## CONTRIBUTORS TO DRAFTING AND REVIEW

Abouchaar, J.	Air Transport Association, Canada
Aguilar, J.	DGSNR, France
Akiyama, H.	Nuclear Fuel Transport Co., Japan
Alonso, A.	Consejo de Seguridad Nuclear, Spain
Altemos, E.	International Civil Aviation Organization
Alter, U.	Bundesministerium für Umwelt, Naturschutz und Reaktorsicherheit, Germany
Aly, A.	Canadian Nuclear Safety Commission, Canada
Ando, H.	Japan Nuclear Cycle Development Institute, Japan
Arendt, J.	Oak Ridge Institute of Science and Energy, United States of America
Asaoka, H.	Nuclear Safety Bureau, Japan
Azurin, C.	Permanent Mission of Peru to the International Organizations in Vienna
Baekelandt, L.	Federal Agency for Nuclear Control, Belgium
Bakalova, A.	Committee on the Use of Atomic Energy for Peaceful Purposes, Bulgaria
Barker, R.	International Atomic Energy Agency
Bayley, B.	World Nuclear Transport Institute, United Kingdom
Bekker, B.	Nuclear Technology Products, South Africa
Bell, K.-H.	Federal Ministry of Transport, Building and Housing, Germany
Benassai, S.	Agenzia Nazionale per la Protezione dell'Ambiente, Italy

## CONTRIBUTORS TO DRAFTING AND REVIEW

Beninson, D.	National Board for Nuclear Regulations, Argentina
Bernard-Bruls, X.	International Atomic Energy Agency
Berserik, J.	Ministry of Housing, Physical Planning and Environment, Netherlands
Biaggio, A.	Ente Nacional Regulador Nuclear, Argentina
Binet, J.	European Commission
Bishop, A.	Atomic Energy Control Board, Canada
Bisht, J.	Bhabha Atomic Research Centre, India
Blackman, D.	Department of Transport, United Kingdom
Blalock, L.G.	Department of Energy, United States of America
Boag, J.	Ontario Hydro, Canada
Bologna, L.	Agenzia Nazionale per la Protezione dell'Ambiente, Italy
Börst, F.-M.	Bundesamt für Strahlenschutz, Germany
Bove, R.	Ente Nazionale per le Nuove Tecnologie, l'Energia e l'Ambiente, Italy
Boyle, R.	Department of Transportation, United States of America
Brach, E.W.	Nuclear Regulatory Commission, United States of America
Bratt, E.	Nuclear Electric plc, United Kingdom
Breest, H.C.	Federal Ministry for the Environment, Nature Conservation and Nuclear Safety, Germany
Brélaz, P.	Division Principale de la Sécurité des Installations Nucléaires, Switzerland
Brittinger, M.T.	International Atomic Energy Agency
Brown, G.	Department of Transportation, United States of America

## CONTRIBUTORS TO DRAFTING AND REVIEW

Brown, R.	Atomic Energy Control Board, Canada
Brown, R.	Mallinckrodt Medical Inc., United States of America
Bruno, N.	Brazilian Nuclear Energy Commission, Brazil
Burbidge, G.	Nordion International, Canada
Bye, R.	Health and Safety Executive, United Kingdom
Carr, N.	UK NIREX Ltd, United Kingdom
Carrington, C.	Amersham International plc, United Kingdom
Carter, M.	Department of Energy, United States of America
Carvajal, P.	Ministry of Defence, Chile
Charette, M.	Atomic Energy Control Board, Canada
Chatterjee, R.	Atomic Energy Control Board, Canada
Cheron, M.P.	Cogéma, France
Cheshire, R.	British Nuclear Fuels plc, United Kingdom
Cho, K.	Korea Institute of Nuclear Safety, Republic of Korea
Christ, R.	World Nuclear Transport Institute, United Kingdom
Clark, R.	Transport Canada, Canada
Claverie-Forgues, S.	Institut de Protection et de Sûreté Nucléaire, France
Cochrane, R.J.	Nuclear Fuels Corporation of South Africa Pty, South Africa
Colgan, P.	Australian Radiation Protection and Nuclear Safety Agency, Australia
Collin, F.	Bundesamt für Strahlenschutz, Germany
Cook, A.	Permanent Mission of New Zealand to the International Organizations in Vienna

## CONTRIBUTORS TO DRAFTING AND REVIEW

Cook, J.	Nuclear Regulatory Commission, United States of America
Cosack, M.	Bundesamt für Strahlenschutz, Germany
Cottens, E.	Federal Agency for Nuclear Control, Belgium
Cousinou, P.	Commissariat à l'Énergie Atomique, France
Cox, J.	Dangerous Goods Transportation Consultant, United Kingdom
Crook, J.	Nuclear Regulatory Commission, United States of America
D'Amato, E.	National Board for Nuclear Regulations, Argentina
Dekker, B.	World Nuclear Transport Institute, United Kingdom
Desnoyers, B.	Cogéma, France
Devillers, C.	Institut de Protection et de Sûreté Nucléaire, France
Devine, I.	Nuclear Electric plc, United Kingdom
Devine, M.	Atomic Energy Control Board, Canada
Dicke, G.	International Atomic Energy Agency
Dougall, I.	Nuclear Electric plc, United Kingdom
Droste, B.	Bundesanstalt für Materialforschung und -prüfung, Germany
Ducháček, V.	State Office for Nuclear Safety, Czech Republic
Dufva, B.	Swedish Nuclear Power Inspectorate, Sweden
Dybeck, P.	Swedish Nuclear Fuel and Waste Management Co., Sweden
Easton, E.	Nuclear Regulatory Commission, United States of America
El Shinawy, R.	Atomic Energy Authority, Egypt
Elbourne, R.	International Air Transport Association
Enriquez, C.	Empresa Nacional de Residuos Radiactivos, Spain

## CONTRIBUTORS TO DRAFTING AND REVIEW

Ericsson, A.-M.	AMC Konsult, Sweden
Ershov, V.	MINATOM, Russian Federation
Ertürk, K.	Turkish Atomic Energy Authority, Turkey
Eyre, P.	Canadian Nuclear Safety Commission, Canada
Faille, S.	Canadian Nuclear Safety Commission, Canada
Falci, F.	International Energy Consultants Inc., United States of America
Faloci, C.	Ente Nazionale per le Nuove Tecnologie, l'Energia e l'Ambiente, Italy
Farris, L.	International Federation of Air Line Pilots Associations
Fasten, C.	Bundesamt für Strahlenschutz, Germany
Fedin, V.	Permanent Mission of the Russian Federation to the International Organizations in Vienna
Feltin, C.	Institut de Protection et de Sûreté Nucléaire, France
Fisk, R.	Edlow International Co., United States of America
Franco, P.	Consejo de Seguridad Nuclear, Spain
Francois, P.	Institut de Protection et de Sûreté Nucléaire, France
Fujinaga, H.	Japan Nuclear Fuel Conversion Co. Ltd, Japan
Gaal, P.	National Institute of Hygiene and Epidemiology, Slovakia
Gale, B.	Atomic Energy of Canada Ltd, Canada
Garg, R.	Canadian Nuclear Safety Commission, Canada
Gemander, R.	Bundesministerium für Wissenschaft, Verkehr und Kunst, Austria
Gessl, M.	International Federation of Air Line Pilots Associations

## CONTRIBUTORS TO DRAFTING AND REVIEW

Gibson, W.	Atomic Energy of Canada Ltd, Canada
Gioria, G.	Instituto de Casaccia de l'ENEA, Italy
Golder, F.	Institute of Isotopes, Hungary
Goldfinch, E.	Nuclear Technology Publishing, United Kingdom
Gomaa, M.	Atomic Energy Authority, Egypt
González, A.	International Atomic Energy Agency
González, J.	Empresa Nacional de Residuos Radiactivos, Spain
Gottachalk, P.-A.	European Federation for Non-destructive Testing, Germany
Grainger, L.	Economic Commission for Europe
Grenier, M.	Institut de Protection et de Sûreté Nucléaire, France
Hack, H.	International Federation of Air Line Pilots Associations
Hägglblom, E.	Swedish Nuclear Power Inspectorate, Sweden
Hall, G.	AWE, United Kingdom
Hallemans, J.-M.	European Commission
Hamada, S.	Ministry of Economy, Trade and Industry, Japan
Hamard, J.	Institut de Protection et de Sûreté Nucléaire, France
Hannibal, L.	National Institute of Radiation Hygiene, Denmark
Harbison, S.	Nuclear Installations Inspectorate, United Kingdom
Harmon, L.	Department of Energy, United States of America
Harrison, M.	United Kingdom Atomic Energy Authority, United Kingdom
Harvey, J.	United Kingdom Atomic Energy Authority, United Kingdom
Haughney, C.	Nuclear Regulatory Commission, United States of America
Hayes, T.	British Nuclear Fuels plc, United Kingdom



## CONTRIBUTORS TO DRAFTING AND REVIEW

Heilbron, P.	Brazilian Nuclear Energy Commission, Brazil
Hennenhofer, G.	Federal Ministry for the Environment, Nature Conservation and Nuclear Safety, Germany
Hesse, H.	International Maritime Organization
Higashi, S.	Science and Technology Agency, Japan
Hinrichsen, P.	National Nuclear Regulator, South Africa
Hirata, J.	International Atomic Energy Agency
Hirose, M.	Mitsui Engineering and Shipbuilding Co. Ltd, Japan
Hladik, I.	State Office for Nuclear Safety, Czech Republic
Hoffmann, M.	Bundesamt für Strahlenschutz, Germany
Hohenburg, J.	Federal Ministry for Health, Sport and Consumer Protection, Austria
Hopkins, D.	International Energy Consultants Inc., United States of America
Hornkjøl, S.	Norwegian Radiation Protection Authority, Norway
Huang, Q.	National Nuclear Safety Administration, China
Hughes, J.	National Radiological Protection Board, United Kingdom
Hussain, A.	Atomic Energy Authority, Egypt
Iida, T.	The Japan Research Institute Ltd, Japan
Ikezawa, Y.	Institute of Radiation Measurements, Japan
Ito, T.	Japan Nuclear Cycle Development Institute, Japan
Itoh, C.	Central Research Institute of Electric Power Industry, Japan
Iwasawa, N.	Japan Nuclear Fuel Co. Ltd, Japan
Jackson, B.J.	Atomic Energy of Canada Ltd, Canada

## CONTRIBUTORS TO DRAFTING AND REVIEW

Jankowski, G.	Amersham International plc, United Kingdom
Johnson, G.M.	International Air Transport Association
Johnson, R.	United Kingdom Atomic Energy Authority, United Kingdom
Johnston, B.	Atomic Energy Control Board, Canada
Josefsson, D.	Swedish Radiation Protection Institute, Sweden
Joseph, D.	Atomic Energy Control Board, Canada
Jurina, V.	Ministry of Health, Slovakia
Jutle, K.	National Nuclear Regulator, South Africa
Kafka, G.	Bundesministerium für Wissenschaft, Verkehr und Kunst, Austria
Keane, M.	Department of Energy, United States of America
Keenan, N.	Council for Nuclear Safety, South Africa
Kervella, O.	Economic Commission for Europe
Kirkhope, K.	Canadian Nuclear Safety Commission, Canada
Kitamura, T.	Japan Nuclear Cycle Development Institute , Japan
Knecht, B.	Swiss Federal Nuclear Safety Inspectorate, Switzerland
Köksal, E.	Turkish Atomic Energy Authority, Turkey
Komarov, E.I.	Institute of Radiation Hygiene, Russian Federation
Krammer, O.	Bundesministerium für Wissenschaft, Verkehr und Kunst, Austria
Krembel, D.	Direction de la Sûreté des Installations Nucléaires, France
Krzaniak, M.	MDS Nordion, Canada
Kubo, M.	Power Reactor and Nuclear Fuel Development Corp., Japan
Kwon, S.-G.	Korea Institute of Nuclear Safety, Korea

## CONTRIBUTORS TO DRAFTING AND REVIEW

Lacoste, A.	DGSNR, France
Lange, F.	Gesellschaft für Anlagen und Reaktorsicherheit GmbH, Germany
Laumond, A.	Electricité de France, France
Le Mao, S.	Institut de Protection et de Sûreté Nucléaire, France
Lee, H.	Nuclear Regulatory Commission, United States of America
Lesage, M.	World Nuclear Transport Institute, United Kingdom
Levin, I.	Nuclear Research Center Negev, Israel
Lewis, R.	Nuclear Regulatory Commission, United States of America
Liai, D.	Israel Atomic Energy Commission, Israel
Liebens, M.	Federal Agency for Nuclear Control, Belgium
Lillian, D.	Department of Energy, United States of America
Lim, Y.K.	Korea Institute of Public Safety, Republic of Korea
Lo, K.	Ontario Power Generation, Canada
Lokan, K.	Australian Radiation Laboratory, Australia
Lombard, J.	Institut de Protection et de Sûreté Nucléaire, France
Lopez Vietri, J.	Autoridad Regulatoria Nuclear, Argentina
Luna, R.	Sandia National Laboratories, United States of America
Macnab, D.	Nuclear Safety Bureau, Australia
Mairs, J.	Department of Transport, United Kingdom
Malesys, P.	International Organization for Standardization
Marchal, E.	Consejo de Seguridad Nuclear, Spain
Marchal, M.	Commission of the European Communities

## CONTRIBUTORS TO DRAFTING AND REVIEW

Mathieu, F.	Institut de Protection et de Sûreté Nucléaire, France
Maudiut, C.	Cogéma, France
McCulloch, N.	International Air Transport Association
McLellan, J.	Atomic Energy Control Board, Canada
Mennerdahl, D.	E. Mennerdahl Systems, Sweden
Metcalf, P.	International Atomic Energy Agency
Mezrahi, A.	Brazilian Nuclear Energy Commission, Brazil
Micheti, P.	ENEA, Italy
Migenda, J.	Safety Technology Management GmbH, Switzerland
Mikawa, S.	Japan Airlines, Japan
Mine, Y.	Nippon Kaiji Kentei Kyokai, Japan
Mišák, J.	Nuclear Regulatory Authority of the Slovak Republic, Slovakia
Mitsubishi, I.	Toshiba Corporation Power Systems and Service Co., Japan
Mkhabela, P.	National Nuclear Regulator, South Africa
Mori, R.	Nippon Nuclear Fuel Development Co. Ltd, Japan
Mountford-Smith, T.	Australian Radiation Protection and Nuclear Safety Agency, Australia
Muñoz, J.	Consejo de Seguridad Nuclear, Spain
Muramatsu, K.	Japan Atomic Energy Research Institute, Japan
Murthy, M.	Bhabha Atomic Research Centre, India
Nagahama, H.	Kobe Steel Co. Ltd, Japan
Nakahashi, T.	International Atomic Energy Agency
Nakajima, T.	Science and Technology Agency, Japan

## CONTRIBUTORS TO DRAFTING AND REVIEW

Nakamura, C.	Japan Atomic Energy Research Institute, Japan
Nakamura, Y.	Japan Radioisotope Association, Japan
Nakashima, S.	Nuclear Safety Bureau, Japan
Nakayama, T.	Ministry of Transport, Japan
Nandakumar, A.N.	Bhabha Atomic Research Centre, India
Neubauer, J.	Forschungszentrum Seibersdorf, Austria
Neven, M.	Cameco Corp., Canada
Nickell, R.	Private consultant, United States of America
Niel, J.C.	Institut de Protection et de Sûreté Nucléaire, France
Nishe, T.	Ministry of Land, Infrastructure and Transport, Japan
Nitsche, F.	Bundesamt für Strahlenschutz, Germany
Noichi, K.	Ministry of Transport, Japan
Nomura, M.	Japan Atomic Energy Research Institute, Japan
O'Grady, K.	Transport Canada, Canada
O'Steen, J.	Department of Transportation, United States of America
O'Sullivan, R.	International Atomic Energy Agency
Ohashi, M.	Mitsubishi Heavy Industries Ltd, Japan
Okimoto, K.	Ministry of Land, Infrastructure and Transport, Japan
Olsson, R.	Swedish Nuclear Power Inspectorate, Sweden
Orsini, A.	Ente Nazionale per le Nuove Tecnologie, l'Energia e l'Ambiente, Italy
Osgood, N.	Nuclear Regulatory Commission, United States of America
Paganelli, M.	Agenzia Nazionale per la Protezione dell'Ambiente, Italy

## CONTRIBUTORS TO DRAFTING AND REVIEW

Parks, C.	Oak Ridge National Laboratory, United States of America
Pawlak, A.	National Inspectorate for Radiation and Nuclear Safety, Poland
Peat, G.	Australian Nuclear Science and Technology Organization, Australia
Pecover, C.	Department of Transport, United Kingdom
Perrin, M.-L.	Institut de Protection et de Sûreté Nucléaire, France
Pertuis, V.	Direction de la Sûreté des Installations Nucléaires, France
Pettersson, B.	Swedish Nuclear Power Inspectorate, Sweden
Pittuck, A.	Transport Canada, Canada
Plourde, K.	Transport Canada, Canada
Pollog, T.	Department of Energy, United States of America
Pope, R.	International Atomic Energy Agency
Prêtre, S.	Division Principale de la Sécurité des Installations Nucléaires, Switzerland
Pryor, W.	PAI Corp., United States of America
Pu, Y.	China National Nuclear Corp., China
Punch, F.	Department of Energy, United States of America
Rahim, I.	International Maritime Organization
Rawl, R.	International Atomic Energy Agency
Read, J.	Transport Canada, Canada
Reculeau, J.	Institut de Protection et de Sûreté Nucléaire, France
Reynolds, R.	Martin Marietta Energy Systems Inc., United States of America
Ridder, K.	Ministry of Transport, Building and Housing, Germany

## CONTRIBUTORS TO DRAFTING AND REVIEW

Ringot, C.	Institut de Protection et de Sûreté Nucléaire, France
Roberts, A.	Department of Transportation, United States of America
Rödel, R.	Bundesanstalt für Materialforschung und -prüfung, Germany
Rogers, D.	REVISS Services (UK) Ltd, United Kingdom
Rooney, K.	International Civil Aviation Organization
Rosemont, G.	Ministère de la Santé Publique et de l'Environnement Belgium
Rosen, M.	International Atomic Energy Agency
Ross, B.	Health and Safety Executive, United Kingdom
Rossi, L.	European Commission
Roubertie, V.	World Nuclear Transport Institute, United Kingdom
Rubio, E.	Consejo de Seguridad Nuclear, Spain
Saegusa, T.	Central Research Institute of Electric Power Industry, Japan
Sáfár, J.	Hungarian Atomic Energy Authority, Hungary
Sannen, H.	Transnubel, Belgium
Sanui, T.	Nuclear Fuel Transport Co. Ltd, Japan
Sato, K.	Nuclear Safety Commission, Japan
Schneider, T.	CEPN, France
Schuurman, W.	International Federation of Air Line Pilots Associations
Scott, H.	Nuclear Regulatory Commission, United States of America
Scott, R.	Department of Energy, United States of America
Šebestová, E.	State Office for Nuclear Safety, Czech Republic
Selling, H.	Ministry of Housing, Spatial Planning and the Environment, Netherlands

## CONTRIBUTORS TO DRAFTING AND REVIEW

Semenov, B.	International Atomic Energy Agency
Sert, G.	Institut de Protection et de Sûreté Nucléaire, France
Shaw, K.	National Radiological Control Board, United Kingdom
Shigeiri, Y.	Central Research Institute of Electric Power Industry, Japan
Shinohara, T.	Ministry of Transport, Japan
Shiomi, S.	Central Research Institute of Electric Power Industry, Japan
Singh, D.	Atomic Energy Regulatory Board, India
Sirisena, K.	International Atomic Energy Agency
Siwicki, R.	National Inspectorate for Radiation and Nuclear Safety, Poland
Smith, L.	Swiss Federal Nuclear Safety Inspectorate, Switzerland
Smith, R.	British Nuclear Fuels plc, United Kingdom
Stalder, F.	Institut Fédéral de Recherches en matière de Réacteurs, Switzerland
Stean, R.	World Nuclear Transport Institute, United Kingdom
Stewart, J.	Department of Transport, United Kingdom
Stolz, W.	Bundesministerium für Wissenschaft, Verkehr und Kunst, Austria
Sukhovarov-Zhornovy, B.	Ministry of Fuel and Energy of Ukraine, Ukraine
Sullivan, G.	Ontario Hydro, Canada
Suzuki, H.	Nuclear Fuel Transport Co. Ltd, Japan
Suzuki, K.	Science and Technology Agency, Japan
Svahn, B.	Swedish Radiation Protection Institute, Sweden
Syssoev, V.	Ministry of Atomic Energy, Russian Federation



## CONTRIBUTORS TO DRAFTING AND REVIEW

Szumski, W.	National Inspectorate for Radiation and Nuclear Safety, Poland
Takahashi, K.	Ministry of Land, Infrastructure and Transport, Japan
Tamura, Y.	Ministry for Nuclear and Industrial Safety, Japan
Tanaka, S.	Mitsubishi Materials Co., Japan
Taniuchi, H.	Kobe Steel Co. Ltd, Japan
Taylor, J.M.	Nuclear Regulatory Commission, United States of America
Taylor, M.	Atomic Energy Control Board, Canada
Timpert, F.	Safety Technology Management GmbH, Switzerland
Tisdall, A.	International Federation of Air Line Pilots Associations
Toda, S.	Science and Technology Agency, Japan
Torres, G.	Permanent Mission of Chile to the International Organizations in Vienna
Trivelloni, S.	Agenzia Nazionale per la Protezione dell'Ambiente, Italy
Tshuva, A.	Israel Atomic Energy Commission, Israel
Tylor, J.	Nuclear Installations Inspectorate, United Kingdom
Valentin, J.	Swedish Radiological Protection Institute, Sweden
Vallée, R.	Institut de Protection et de Sûreté Nucléaire, France
Van Gerwen, I.	Commission of the European Communities
Van Halem, H.	Ministry of Housing, Spatial Planning and the Environment, Netherlands
Van Oosterwijk, R.	Ministry of Transportation, Netherlands
Vaughan, R.	Croft Associates, United Kingdom
Vergara, J.	Commission of Nuclear Energy, Chile

## CONTRIBUTORS TO DRAFTING AND REVIEW

Vieru, G.	Institute for Nuclear Research, Romania
Vnukov, V.	Institute of Physics and Power Engineering, Russian Federation
Wang, J.M.	China Institute for Radiation Protection, China
Wangler, M.	International Atomic Energy Agency
Waragai, H.	Science and Technology Agency, Japan
Wardelmann, H.	International Maritime Organization
Warden, D.	Nycomed-Amersham plc, United Kingdom
Warniez, P.	Commissariat à l'Énergie Atomique, France
Watanabe, K.	Nuclear Safety Bureau, Japan
Watanabe, Y.	Japan Airlines, Japan
Webb, G.	International Atomic Energy Agency
Webster, A.	Department of Transport, United Kingdom
Wieser, K.	Bundesanstalt für Materialforschung und -prüfung, Germany
Wilkinson, W.	World Nuclear Transport Institute, United Kingdom
Wilson, C.	Department of Transport, United Kingdom
Windelberg, D.	University of Hannover, Germany
Xavier, A.	Brazilian Nuclear Energy Commission, Brazil
Yamada, Y.	Nuclear Fuel Industries Ltd, Japan
Yasogawa, Y.	Nippon Kaiji Kentei Kyokai, Japan
Yoshida, S.	Science and Technology Agency, Japan
Yoshikai, K.	Ministry of Land, Infrastructure and Transport, Japan
Yoshikane, I.	International Atomic Energy Agency

## CONTRIBUTORS TO DRAFTING AND REVIEW

Young, C.	Department of Transport, United Kingdom
Zamora, F.	Consejo de Seguridad Nuclear, Spain
Zeisler, P.	Bundesanstalt für Materialforschung und -prüfung, Germany
Zhao, Y.	Permanent Mission of China to the International Organizations in Vienna
Zlauvinen, G.	Permanent Mission of Argentina to the International Organizations in Vienna

### **Review Panel Meetings**

Vienna, Austria: 22–26 June 1987,  
10–14 July 1989, 4–8 September 2000,  
12–16 November 2001

### **Technical Committee Meetings**

Vienna, Austria: 2–6 May 1988, 11–15 October 1993,  
27 June–1 July 1994, 15–19 May 1995,  
12–16 June 1995

### **Advisory Group Meetings**

Vienna, Austria: 2–6 December 1991,  
6–10 March 1995

### **Revision Panel Meetings**

Vienna, Austria: 10–14 June 1991,  
17–21 May 1993, 10–14 October 1994,  
25–29 September 1995

### **Transport Safety Standards Advisory Committee Meetings**

Vienna, Austria: 26 February–1 March 1996,  
15–19 May 2000

### **Transport Safety Standards Committee Meetings**

Vienna, Austria: 5–9 February 2001,  
4–8 March 2002

## INDEX

(by paragraph number)

Accident conditions: 106, 402, 636, 671, 682, 726

Activity limits: 201, 230, 401, 411, 815–817

A<sub>1</sub>: 201, 401–410, 413, 414, 416, 558, 820

A<sub>2</sub>: 201, 226, 401–410, 412–414, 416, 549, 558, 601, 605, 656, 657, 669, 730, 820

Air (transport by): 106, 217, 412, 416, 531, 576–578, 580, 617–621, 633, 650, 652, 662, 680, 816, 817

Ambient conditions: 615, 617–619, 643, 651–653, 662, 664, 668, 676, 703, 710, 711, 728, 810, 831, 833

Basic Safety Standards: 101, 304

Carrier: 203, 206, 311, 555, 556, 831

Categories of package: 533, 541, 543, 549, 563, 573

Certificate of approval: 415–418, 502, 544, 549, 557, 559, 561, 565, 676, 801, 804, 805, 808, 811, 814, 823, 826–834

Competent authority: 104, 204, 205, 207–209, 238, 301, 304, 310–312, 402, 510, 537, 538, 544, 549, 556–558, 565, 575, 582, 603, 632, 638, 665, 667, 676, 711, 801, 802, 804, 805, 808, 811, 813–819, 821, 823, 825–834

Compliance assurance: 102, 105, 208, 311

Confinement system: 209, 501, 678

Consignee: 210, 221, 534, 581

Consignment: 203, 204, 210–212, 229, 236–238, 307, 309, 312, 401, 404, 505, 506, 529, 530, 546, 547, 549, 550, 553, 555–559, 564, 566, 567, 570–572, 575, 576, 579, 580, 582, 672, 803, 824, 825, 831–833

Consignor: 211, 212, 221, 229, 310, 311, 505, 534, 548–552, 555–558, 560, 561, 580, 801, 831–833

Containment: 104, 618, 651

Containment system: 213, 228, 501, 502, 619, 630, 639–643, 645, 648, 657, 659, 660, 670, 677, 682, 714, 716, 724, 807

## INDEX

- Contamination: 214–216, 241, 508–510, 512, 513, 520, 523, 656, 669
- Conveyance: 104, 217, 221, 223, 411, 510, 512–514, 523, 525, 527, 555, 566, 569, 606, 672, 807, 822, 831, 832
- Cooling system: 577, 658
- Criticality: 101, 104, 209, 566–569, 716, 820, 831–833
- Criticality safety index: 218, 528–530, 544, 545, 549, 566–569, 820, 831, 833, 835
- Customs: 581
- 
- Dangerous goods: 109, 506, 507, 562
- Deck area: 217, 219
- Decontamination: 513
- Dose limits: 302
- 
- Emergency: 102, 308, 309, 555, 831–833
- Empty packaging: 520, 554
- Excepted package: 222, 226, 230, 408–410, 514–520, 535, 541, 546, 549, 554, 575, 620, 649, 671, 672, 709, 731, 802, 812, 815, 828, 829
- Exclusive use: 221, 505, 514, 523, 530–533, 540, 547, 549, 566, 567, 570–572, 574, 576, 652, 662
- Exemption values: 107, 226, 236, 401–406
- 
- Fissile material: 209, 218, 222, 226, 230, 418, 501, 502, 507, 515, 522, 528, 541, 543, 545, 549, 559, 568, 569, 629, 671–682, 716, 731–733, 802, 806, 809, 812–814, 816, 817, 820, 828, 829, 831–833
- Freight container: 218, 221, 223, 231, 243, 509, 514, 526, 527, 541–543, 545–547, 549, 555, 562, 566, 568–570, 573, 627, 807, 831, 832
- Gas: 242, 642, 649
- 
- Heat: 104, 501, 555, 565, 603, 651, 704, 708, 728, 807, 831–833
- 
- Identification mark: 538, 549, 804, 805, 808, 811, 814, 828–833

## INDEX

- Industrial package: 230, 411, 412, 521, 524, 525, 537, 621–628, 815, 828, 829
- Insolation: 617, 654, 662, 728
- Inspection: 301, 310, 311, 502, 581, 801
- Intermediate bulk container: 224, 231, 504, 509, 514, 628
- Label: 520, 538, 539, 541–546, 550, 554, 570, 573
- Leaching: 226, 603, 704, 710, 711
- Leakage: 510, 603, 619, 630, 632, 644, 648, 677, 680, 704, 710, 711, 731–733
- Low dispersible radioactive material: 220, 225, 310, 311, 416, 502, 549, 559, 605, 663, 701, 712, 802–804, 806, 809, 827, 828, 830–833
- Low specific activity: 226, 243, 411, 412, 503, 521–526, 540, 543, 547, 549, 566, 571, 601, 626, 701, 703
- Maintenance: 104, 106, 310, 311, 677, 807, 832
- Manufacture: 106, 310, 311, 677, 713, 807, 816, 817, 831, 833
- Marking: 507, 517, 518, 534, 540, 542, 548, 829
- Mass: 240, 246, 418, 419, 536, 543, 549, 559, 606, 608, 656, 672, 673, 682, 709, 722–724, 727, 735, 831, 833
- Maximum normal operating pressure: 228, 660, 661, 668, 669, 807
- Multilateral approval: 204, 312, 402, 718, 803, 805, 806, 809, 812, 816, 817, 820, 824, 828, 829, 834
- N: 528, 681, 682
- Normal conditions: 106, 511, 651, 681, 719
- Notification: 204, 557–560, 819
- Operational controls: 228, 577, 666, 810, 822, 825, 831–833
- Other dangerous properties: 507, 541, 616
- Overpack: 218, 229, 243, 509, 514, 526, 527, 530, 531, 533, 541–543, 545, 549, 555, 562, 563, 565–570, 572–574, 578

## INDEX

Package design: 415–418, 537–539, 544, 549, 557, 616, 676, 801, 805, 806, 809, 810, 812, 816, 817, 822, 827–829, 833

Packaging: 104, 106, 209, 213, 220, 224, 226, 230, 231, 235, 310, 311, 503, 520, 534–538, 554, 580, 609, 613, 629, 637, 641, 645, 651, 663, 675, 677, 678, 701, 718, 723, 807, 815–817, 819, 829, 831–833

Placard: 546, 547, 570, 571

Post: 410, 515, 535, 579, 580

Pressure: 228, 231, 419, 501, 502, 619, 625, 631, 632, 639, 643, 644, 659–661, 668, 669, 718, 729, 730, 807

Pressure relief: 231, 631, 644, 659

Quality assurance: 102, 105, 232, 310, 803, 805, 807, 813, 815–818, 830–833

Radiation exposure: 243, 307, 562, 581

Radiation level: 104, 233, 306, 411, 510, 513, 516, 517, 521, 526, 527, 530–533, 566, 572, 574, 578, 605, 622, 624, 625, 627, 628, 646, 656, 669

Radiation protection: 101, 234, 301, 575, 603, 711, 802, 820

Rail (transport by): 217, 242, 531, 570, 571

Responsibility: 103, 311, 548

Road (transport by): 217, 242, 247, 531, 570–573

Routine conditions: 106, 215, 508, 518, 523, 566, 572, 612, 615, 625, 627, 679

Segregation: 306, 307, 562, 568

Serial number: 538, 816, 819

Shielding: 226, 231, 501, 523, 622, 624, 625, 627, 628, 646, 651, 656, 669, 716

Shipment: 204, 237, 501, 502, 549, 557–561, 572, 575, 674, 677, 802, 803, 807, 820–834

Shipping: 535, 549, 550

Special arrangement: 238, 312, 531, 533, 544, 549, 558, 574, 578, 824–829, 831

Special form: 201, 220, 239, 310, 311, 413, 414, 416, 502, 549, 559, 602–604, 640, 656, 701, 704, 709, 802–804, 818, 827, 828, 830–833

## INDEX

- Specific activity: 226, 240, 503
- Storage: 562, 564, 568
- Stowage: 219, 229, 311, 555, 564, 565, 575, 807, 831–833
- Surface contaminated objects: 241, 243, 411, 503, 504, 521–526, 540, 543, 547, 549, 571
- Tank: 231, 242, 504, 509, 514, 526, 541, 542, 546, 547, 570, 625, 626
- Tank container: 242
- Tank vehicle: 242
- Temperature: 228, 419, 502, 617, 637, 647, 652, 653, 662, 664, 668, 671, 675, 676, 703, 708–711, 728, 810, 831, 833
- Tests: 224, 502, 603, 605, 622, 624, 627, 628, 646, 648, 649, 651, 655, 656, 659, 660, 668, 669, 675, 677–682, 701, 702, 704, 709, 711–713, 716, 717, 719, 725–727, 732, 734, 803, 807
- Tie-down: 231, 242, 636
- Transport documents: 212, 543, 549, 550, 555
- Transport index: 243, 526, 527, 530, 533, 543, 549, 566, 567
- Type A package: 230, 413, 414, 537, 633–649, 725, 815, 828
- Type B(M) package: 230, 415, 416, 538, 558, 576, 578, 665, 666, 730, 802, 809, 810, 811, 820, 828, 829, 833
- Type B(U) package: 230, 650–664, 802, 806, 808, 828
- Type C package: 230, 417, 501, 502, 538, 539, 558, 667–670, 730, 734–737, 802, 806, 808, 828
- Ullage: 419, 647
- Unilateral approval: 205, 502, 803, 805, 806, 818, 828
- United Nations number: 535, 546, 547, 549, 571
- Unpackaged: 223, 243, 517, 521, 523, 525, 526, 547, 571, 672
- Uranium hexafluoride: 230, 419, 526, 629–632, 677, 718, 802, 805, 828, 829
- Vehicle: 217, 219, 242, 247, 537, 570–574, 828



## INDEX

Venting: 228, 231, 666, 820

Vessel: 217, 219, 248, 531, 574, 575, 802, 820

Water: 106, 217, 226, 525, 539, 601, 603, 605, 610, 657, 670, 671, 677, 678,  
680–682, 703, 710, 711, 719–721, 726, 729, 730–733, 831, 833